

LG LED Signage LSAA Series

True Innovation Behind Simplicity

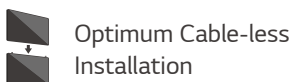

Optimum Cable-less Installation



AI-Powered Image Processor



Dedicated Accessories



Meeting Room Solution Compatibility

* All images are for illustrative purposes only.

OPTIMUM CABLE-LESS DESIGN FOR SIMPLE INSTALLATION

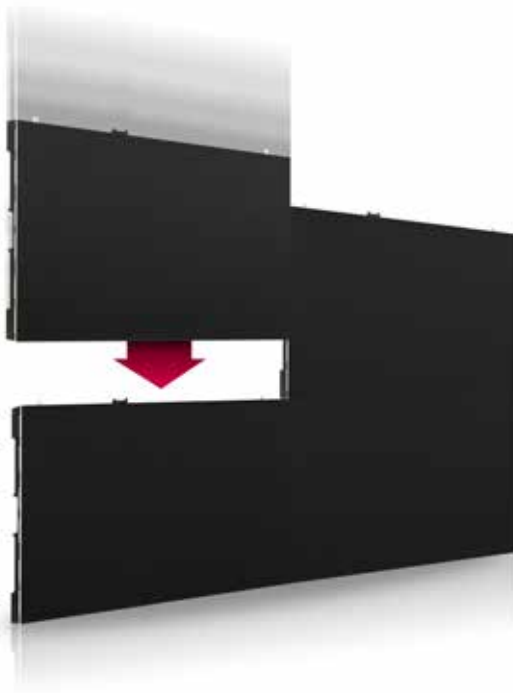

Why “Optimum Cable-less” LED

The LSAA series is the innovative LED signage applying the wireless transmission technology. For up to UHD resolution with the 16:9 ratio, it does not require a cable connection between the cabinets to supply signal & power. Its block assembly design makes the LSAA series easier to be installed than ever before.

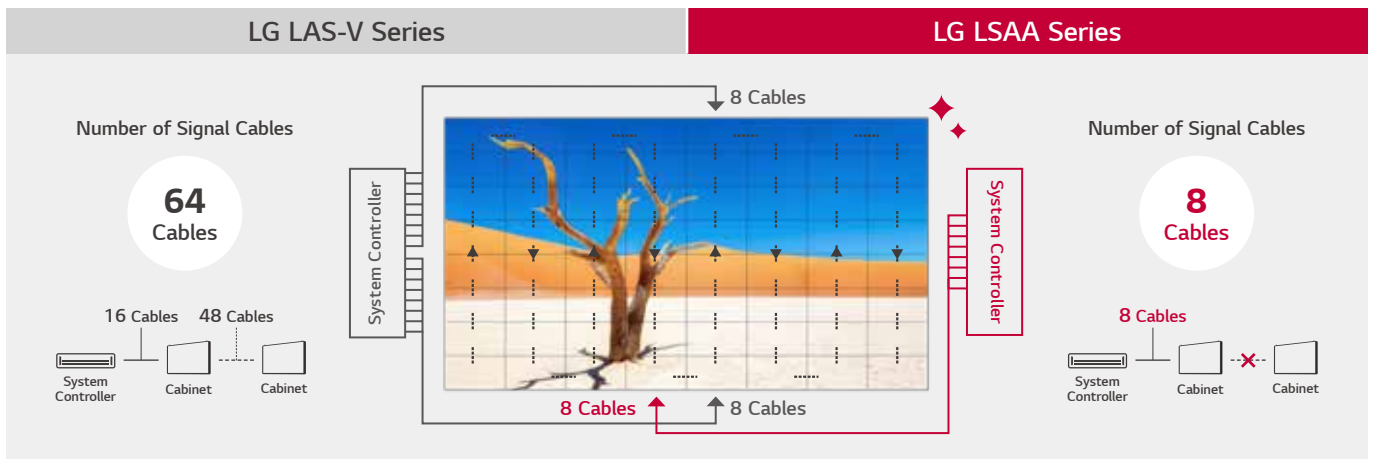
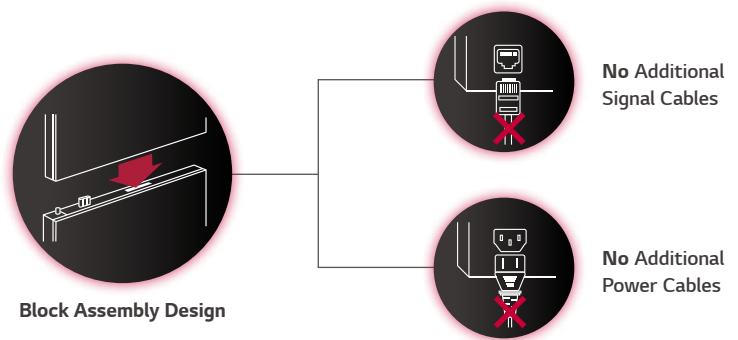

* Based on P1.2, 16:9, UHD Resolution (8x8 Cabinets)

Wireless Data Transfer & Cable-less Power Docking



POWERFUL PICTURE QUALITY

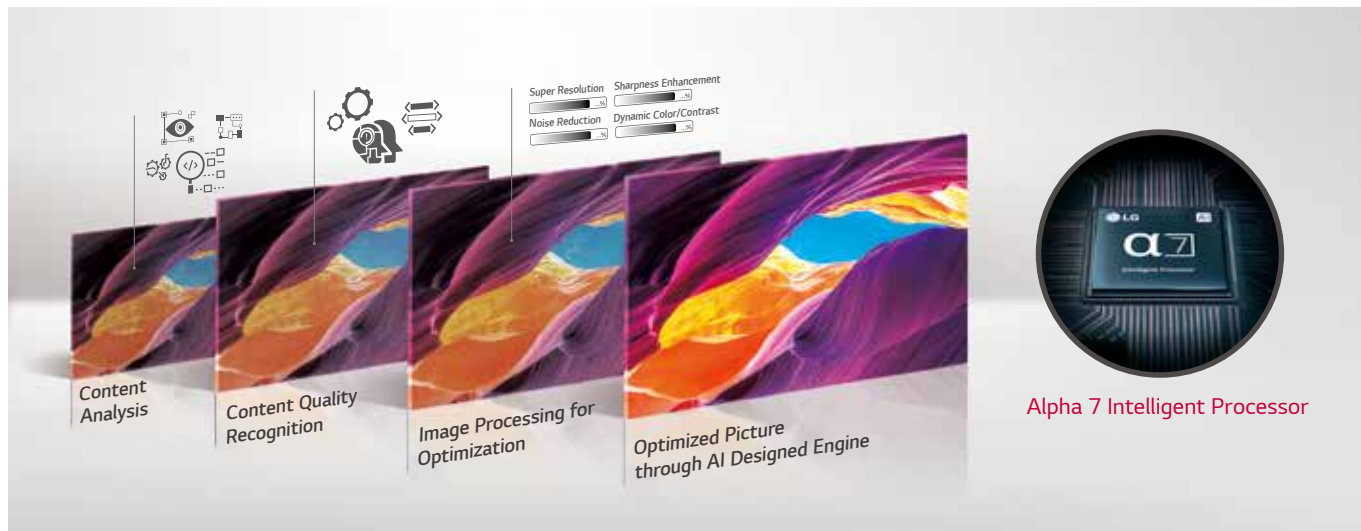

Optimized Image Quality with AI-powered Image Processor

The "Alpha 7 Intelligent Processor" applied to the LSAA series recognizes and analyzes the original content, optimizing the clarity and sharpness of the content for itself.

* The above functions are created by using deep learning AI technology to improve the picture quality.



Vivid Color Expression Powered by HDR

With HDR (HDR10, HDR10 Pro*) support, content becomes vivid with great visual impact. The wider color spectrum and greater contrast ratio allow viewers to fully enjoy lively content.

* HDR10 Pro is LG's own HDR solution for processing HDR signal by using enhanced dynamic tone mapping.

OPTIMUM LED DISPLAY FOR ENTERPRISE USAGE

» Wall Mount Kit



» Floor Stand Kit



» Frame Kit

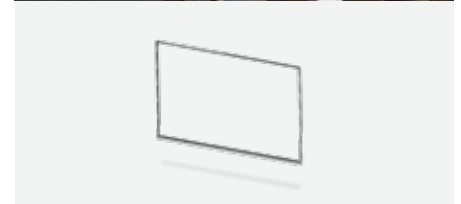

Dedicated Accessories Available

3 types of accessories are available to easily install the LED screen in 16:9, FHD / UHD resolution.

Compatibility	P1.2 108" FHD
Wall Mount Kit	✓
Floor Stand Kit	
Frame Kit	✓

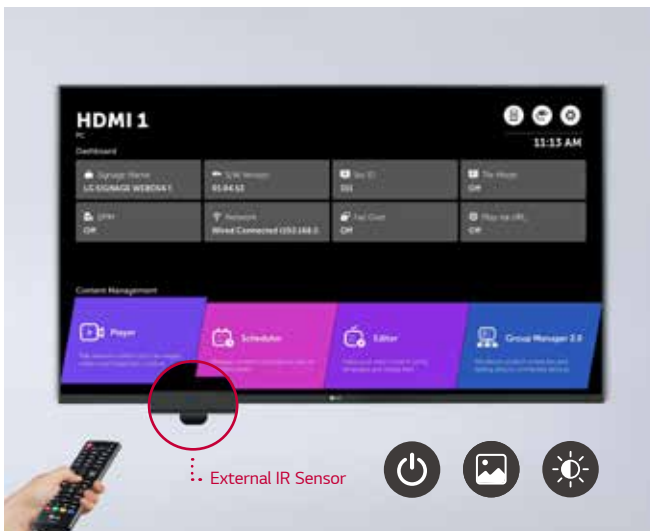

Easy Remote Control Support

The LSAA series allows users to easily access the settings, such as Picture Mode, volume, etc. by using a remote control instead of connecting to a PC. It uses the same UI as general LG digital signage, so users can easily adapt to it.

* The easy-viewing UI menu is available for over 1,280 x 720 resolution screens.



Compatibility with AV Conference Systems

The LSAA series has been certified Crestron Connected® for a high level of compatibility with professional AV controls to achieve seamless integration and automated control*, boosting business management efficiency.

* Network-based control

DELICATE FEATURES CONSIDERING UP-CLOSE USE



EMC Class B Certified

The LG LSAA Series is certified as EMC Class B, which requires electronic equipment made for use in residential environments as well as commercial, industrial, or business environments. Therefore, it is suitable for up-close uses such as corporate meeting rooms, board rooms, etc.

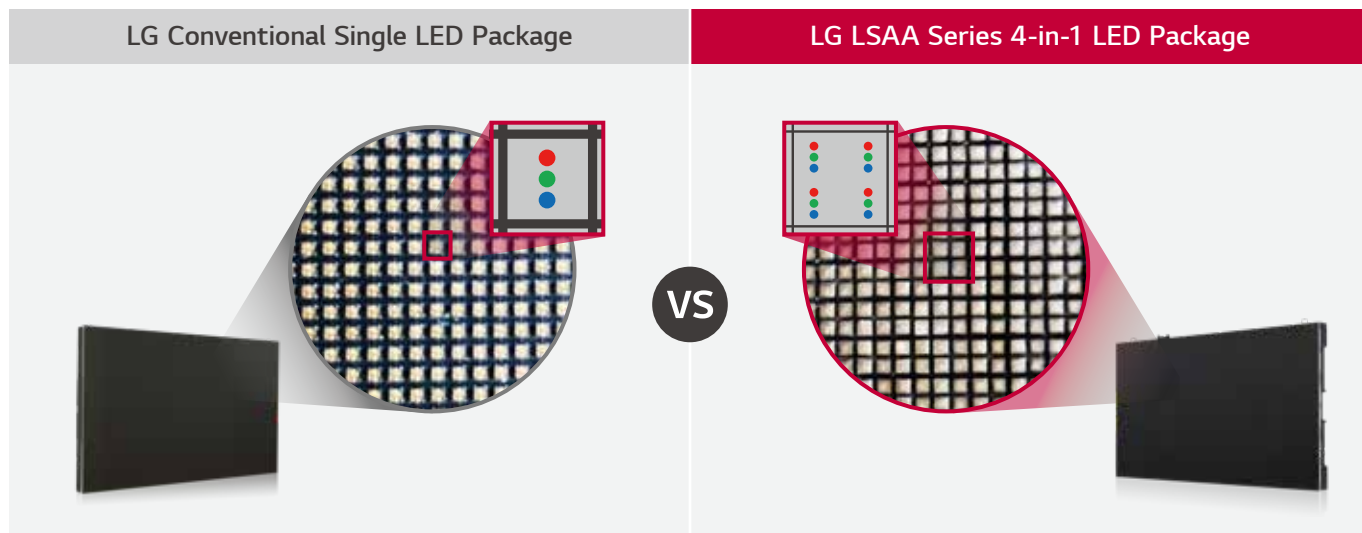

4-in-1 LED Package

Unlike LG's conventional LED signage in which one light source constitutes one small LED package, the LSAA series has applied four light sources at once to its wider LED package. So the attached area of 4-in-1 LED package can be wider than the conventional single LED package, making the LED signage surface smoother and suitable for up-close uses such as corporate meeting rooms etc.

ENHANCED POWER EFFICIENCY

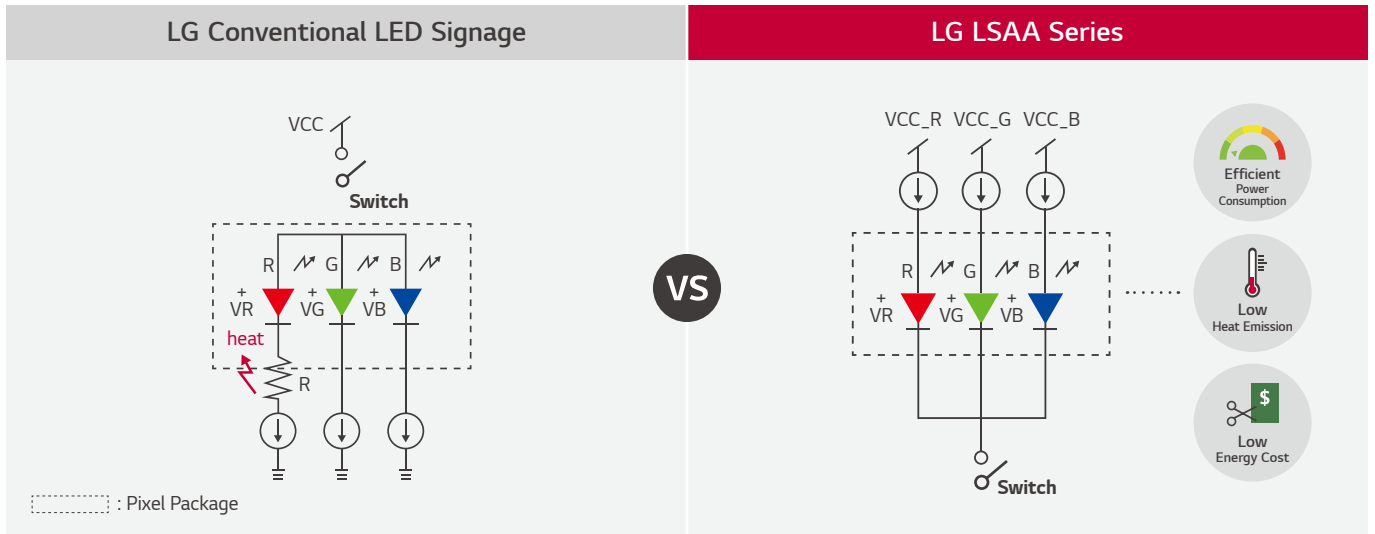

Energy Saving Power System

By applying Common Cathode Drive-IC, LSAA supplies the right necessary voltage to each R/G/B sub-pixel individually, ensuring efficient power consumption.



Standby Mode

When there is no input signal for a period of time, the screen turns off and the main circuit parts inside the LED cabinet go to a standby mode. This saves additional power consumption and enables the product to be reactivated simply by using a remote control.

DELICATE FEATURES FOR OPERATION AND MANAGEMENT



Real-time 365 Care Service

Maintenance is easier and faster with the optional Signage365Care* service, a cloud service solution provided by LG service. It remotely manages the status of displays in client workplaces for fault diagnosis and remote-control services, enabling the stable operation of clients' businesses.

* The availability of the "Signage365Care" service differs by region, so please contact the LG sales representative in your region for more details.

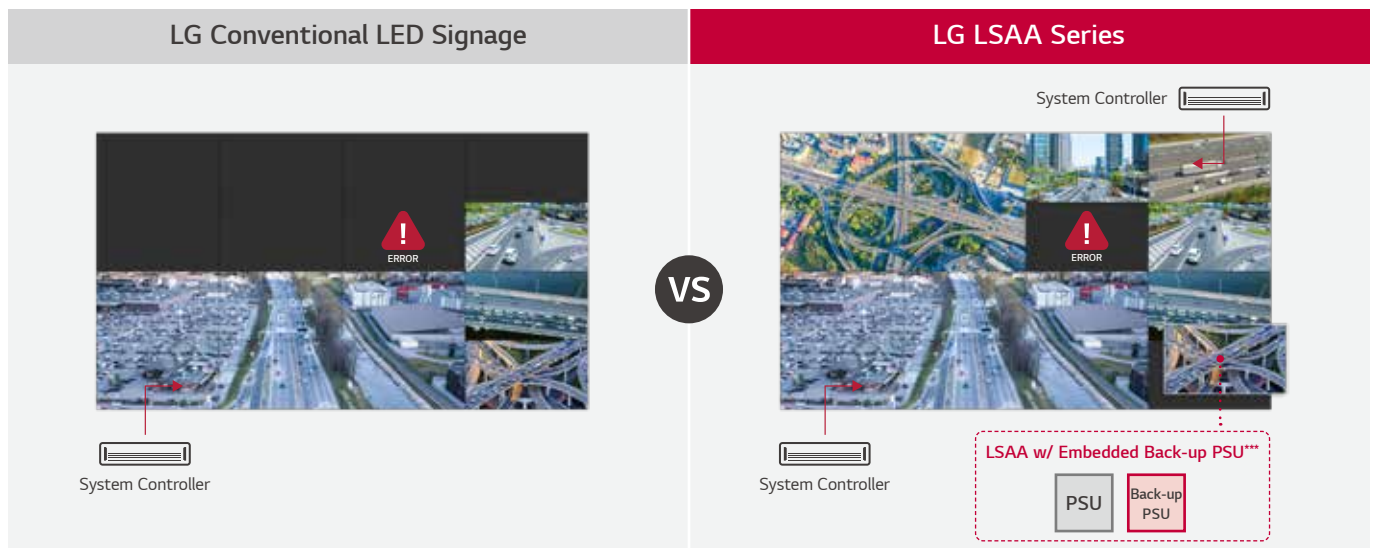

Power/Signal Redundancy Support

The LSAA series is designed to support redundancy of signal and power, providing users with comfort. With an optional embedded back-up power supply unit, customers can assure the continuous operation of the screen without power failure, while the dual controllers minimize screen failure with a bi-directional signal input.

* The "Conventional" shown above refers to LED displays which do not support the power/signal redundancy mode.

** The power/signal redundancy features are available from the third quarter of 2020.

*** The embedded back-up PSU model is optional.

USAGE SCENES



PRODUCT INFORMATION



LG SuperSign webOS

Cabinet	LSAA012
Pixel Configuration	SMD, 4 Pixels in 1 PKG
Pixel Pitch (mm)	1.25
No. of Modules per Cabinet (W x H)	2 x 3
Cabinet Resolution (W x H)	480 x 270
Cabinet Dimensions (W x H x D, mm)	600 x 337.5 x 44.9
Brightness	600 nit (Typ.), 1,200 nit (Peak)
Contrast Ratio	5,000:1 (Typ.), 9,000:1 (Peak)

System Controller	CSAA-012
Resolution	UHD (3,840 x 2,160)
Input Signal	HDMI (3), DP
Output Signal	Ethernet (5 GB x 8 ea), SPDIF (Audio)
Control	IR, RS232C In / Out, Ethernet, USB
HDR Compatibility	HDR10, HDR10 Pro
Built-in Wi-Fi	Yes
Storage	16 GB
Image Enhancement	HDR10 / HDR10 Pro, 3D Color Gamut Mapping, Low Latency, Auto Brightness Control (w/ External Brightness Sensor)
Dimension (W x H x D, mm)	443 x 63 x 298

DIMENSION

(unit: mm)

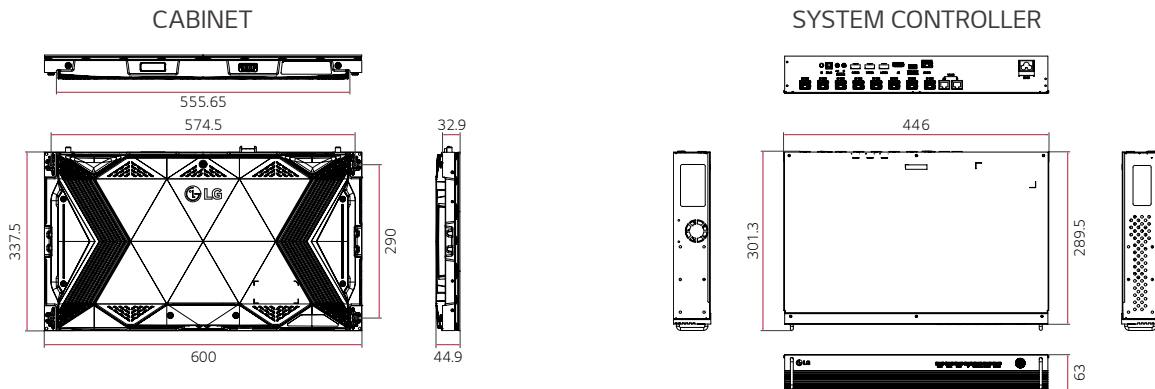

CONNECTIVITY

SYSTEM CONTROLLER

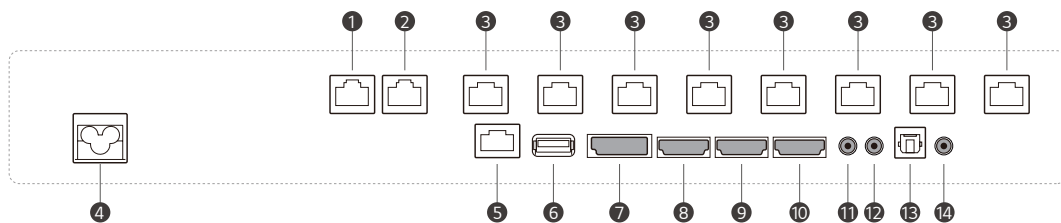

- 1 IR-APL IN
- 2 IR-APL OUT
- 3 Ethernet (5 Gbps)
- 4 AC-IN
- 5 LAN IN
- 6 USB 2.0 IN
- 7 DP
- 8 HDMI 1
- 9 HDMI 2
- 10 HDMI 3
- 11 RS-232C IN
- 12 RS-232C OUT
- 13 OPTIC
- 14 IR

* Dimensions & Jack Panels may differ from the above image, so please contact LG sales team to verify before ordering.



As a continuing policy of product development at LG Electronics, the design and specifications are subject to change. They may vary from model to model. Colour/shades may vary due to printing restrictions. E&OE.



B2B CUSTOMER CARE
 1800-180-9898 (Toll Free)
 5757554 (Send SMS)
www.lg.com/in/support



LG Service India Mobile App Available at Google Play

www.facebook.com/lgindiapage/
www.twitter.com/LGIndia

To know more about LG, visit www.lg.com/in
 For B2B Solutions/Product enquiries, please write to b2b.solutions@lge.com
 For B2B Service, please write to b2bsupport.india@lge.com

