



CONFIDENTIAL

AIR CONDITIONER

SVC MANUAL

Air Cooled Liquid Chilling Package
MODEL : A(C)AH Series

CAUTION

Before Servicing the unit, read the safety precautions in SVC manual.
Only for authorized service personnel.

Air-cooled Inverter Scroll Chiller

1. Safety Precautions	3
2. Specification	8
3. Functions	11
4. Piping Diagrams	12
5. Wiring Diagrams	15
6. Exploded View	27
7. The phenomena from main component failure	49
8. Error code check	70
9. Additional functions	120

1. Safety Precautions



To prevent injury to the user or other people and property damage, the following instructions must be followed.

- Incorrect operation due to ignoring instruction will cause harm or damage. The seriousness is classified by the following indications.

⚠ WARNING This symbol indicates the possibility of death or serious injury.

⚠ CAUTION This symbol indicates the possibility of injury or damage to properties only.

- Meanings of symbols used in this manual are as shown below.

	Be sure not to do.
	Be sure to follow the instruction.

⚠ WARNING

■ Installation

- Installation is to be performed by qualified personnel who are familiar with local codes and regulations.
 - There is risk of fire, electric shock, explosion, or injury.
- Always install a dedicated circuit and breaker.
 - Improper wiring or installation may cause fire or electric shock.
- For re-installation of the installed product, always contact a dealer or an Authorized Service Center.
 - There is risk of fire, electric shock, explosion, or injury.
- Do not install, remove, or re-install the unit by yourself (customer).
 - There is risk of fire, electric shock, explosion, or injury.
- Prepare for strong wind or earthquake and install the unit at the specified place.
 - Improper installation may cause the unit to topple and result in injury.
- When installing and moving the Product to another site, do not charge it with a different refrigerant from the refrigerant specified on the unit.
 - If a different refrigerant or air is mixed with the original refrigerant, the refrigerant cycle may malfunction and the unit may be damaged.
- Securely install the cover of control box and the panel.
 - If the cover and panel are not installed securely, dust or water may enter the outdoor unit and fire or electric shock may result.
- If the Product is installed in a small room, measures must be taken to prevent the refrigerant concentration from exceeding the safety limit when the refrigerant leaks.
 - Consult the dealer regarding the appropriate measures to prevent the safety limit from being exceeded. Should the refrigerant leak and cause the safety limit to be exceeded, hazards due to lack of oxygen in the room could result.
- Use the correctly rated breaker or fuse.
 - There is risk of fire or electric shock.
- Have all electric work done by a licensed electrician according to regulations and the instructions given in this manual and always use a special circuit.
 - If the power source capacity is inadequate or electric work is performed improperly, electric shock or fire may result.

Safety Precautions

- There must be no obstruction above the unit.
 - It would deflect discharge air downward where it could be re-circulated back to the inlet of the condenser coil. The condenser fans are propeller type and will not operate with ductwork on the fan outlet.
- When transporting the product, use the forklift or spreader bar in accordance with the manual.
 - Arbitrarily moving the product can cause product damage or injury.
- When moving the product using the forklift, check the weight of the chiller, size and length of the fork to select the appropriate equipment.
 - It can cause damage or injury.
- When hanging the product on the hoist to move the chiller, make sure that the load of the product is evenly distributed and leveled during the move.
 - It can cause damage or injury.
- When moving the product using the spreader bar, make sure to select the spreader bar with material and size to sufficiently support the strength spreader bar.
 - Using inappropriate spreader bar can cause the product to fall and cause injury due to the strength or size.
- Always ground the product.
 - There is risk of fire or electric shock.
- Do not store or use flammable gas or combustibles near the Product.
 - There is risk of fire or failure of product.
- Do not reconstruct to change the settings of the protection devices.
 - If the pressure switch, thermal switch, or other protection device is shorted and operated forcibly, or parts other than those specified by LGE are used, fire or explosion may result.
- Ventilate before operating Product when gas leaked out.
 - It may cause explosion, fire, and burn.
- Use a vacuum pump or Inert (nitrogen) gas when doing leakage test or air purge. Do not compress air or Oxygen and Do not use Flammable gases. Otherwise, it may cause fire or explosion.
 - There is the risk of death, injury, fire or explosion.

■ Operation

- Do not damage or use an unspecified POWER CABLE.
 - There is risk of fire, electric shock, explosion, or injury.
- Use a dedicated outlet for this appliance.
 - There is risk of fire or electrical shock.
- Be cautious that water could not enter the Product.
 - There is risk of fire, electric shock, or product damage.
- Do not touch the power switch with wet hands.
 - There is risk of fire, electric shock, explosion, or injury.
- When installing and moving the Product to another site, do not charge it with a different refrigerant from the refrigerant specified on the unit.
 - If a different refrigerant or air is mixed with the original refrigerant, the refrigerant cycle may malfunction and the unit may be damaged.
- When the product is soaked (flooded or submerged), contact an Authorized Service Center.
 - There is risk of fire or electric shock.
- Be cautious not to touch the sharp edges and coil.
 - It may cause injury.

- Take care to ensure that nobody could step on or fall onto the outdoor unit.
 - This could result in personal injury and product damage.
- Be careful during valve checkout about hot gas line
 - It may become hot enough to cause injury.
- Electric shock hazard. Can cause severe injury or death. Even when power to the panel is off, output board could be connected to high voltage.
 - Electric shock hazard. Turn off all power before doing any service.

 **CAUTION**

■ **Installation**

- Always check for gas (refrigerant) leakage after installation or repair of product.
 - Low refrigerant levels may cause failure of product.
- Do not install the product where the noise or hot air from the outdoor unit could damage the neighborhoods.
 - It may cause a problem for your neighbors.
- Keep level even when installing the product.
 - To avoid vibration or water leakage.
- Do not install the unit where combustible gas may leak.
 - If the gas leaks and accumulates around the unit, an explosion may result.
- Do not install the product where it is exposed to sea wind (salt spray) directly.
 - It may cause corrosion on the product. Corrosion, particularly on the condenser and evaporator fins, could cause product malfunction or inefficient operation.
- When installing the unit in a hospital, communication station, or similar place, provide sufficient protection against noise.
 - The inverter equipment, private power generator, high-frequency medical equipment, or radio communication equipment may cause the Product to operate erroneously, or fail to operate. On the other hand, the Product may affect such equipment by creating noise that disturbs medical treatment or image broadcasting.
- Use power cables of sufficient current carrying capacity and rating.
 - Cables that are too small may leak, generate heat, and cause a fire.
- Do not use the product for special purposes, such as preserving foods, works of art, etc. It is a consumer Product, not a precision refrigeration system.
 - There is risk of damage or loss of property.
- Keep the unit away from children. The heat exchanger is very sharp.
 - It can cause the injury, such as cutting the finger. Also the damaged fin may result in degradation of capacity.
- The operator must provide protection against water circuit freezing on all Product units.
 - To prevent damage from freezing water.
- The appliance shall be disconnected from its power source during service and when replacing parts.

■ Operation

- Do not use the Product in special environments.
 - Oil, steam, sulfuric smoke, etc. can significantly reduce the performance of the Product or damage its parts.
- Make the connections securely so that the outside force of the cable may not be applied to the terminals.
 - Inadequate connection and fastening may generate heat and cause a fire.
- Be sure the installation area does not deteriorate with age.
 - If the base collapses, the Product could fall with it, causing property damage, product failure, or personal injury.
- Install and insulate the drain hose to ensure that water is drained away properly based on the installation manual.
 - A bad connection may cause water leakage.
- Be very careful about product transportation.
 - Do not touch the heat exchanger fins. Doing so may cut your fingers.
 - When transporting the outdoor unit, suspending it at the specified positions on the unit base. Also support the outdoor unit at four points so that it cannot slip sideways.
- Safely dispose of the packing materials.
 - Packing materials, such as nails and other metal or wooden parts, may cause stabs or other injuries.
 - Tear apart and throw away plastic packaging bags so that children may not play with them. If children play with a plastic bag which was not torn apart, they face the risk of suffocation.
- Turn on the power at least 6 hours before starting operation.
 - Starting operation immediately after turning on the main power switch can result in severe damage to internal parts. Keep the power switch turned on during the operational season.
- Do not touch any of the refrigerant piping during and after operation.
 - It can cause a burn or frostbite.
- Do not operate the Product with the panels or guards removed.
 - Rotating, hot, or high-voltage parts can cause injuries.
- Do not directly turn off the main power switch after stopping operation.
 - Wait at least 5 minutes before turning off the main power switch. Otherwise it may result in water leakage or other problems.
- When re-running the product after keep product long time in a low temperature conditions, touch function may not work temporarily.
 - Wait for a time. After time, product work normally.
- Do not insert hands or other objects through the air inlet or outlet while the Product is plugged in.
 - There are sharp and moving parts that could cause personal injury.
- Field wiring must be installed according to unit wiring diagram.
 - It may cause serious electrical damage can occur.
- Do not use an automotive grade antifreeze. Industrial grade glycols must be used. Automotive antifreeze contains inhibitors which will cause plating on the copper tubes within the Product evaporator. The type and handling of glycol used must be consistent with local codes.
- Electrical power must be applied to the compressor crankcase heaters 3 hours before starting unit to drive off refrigerant from the oil.

2. Specification

Inverter Scroll Chiller		Model	ACAHO20LE(D)TB	ACAHO23LE(D)TB	ACAHO33LE(D)TB	ACAHO40LE(D)TB
			CCAHO20LE(D)TB	CCAHO23LE(D)TB	CCAHO33LE(D)TB	CCAHO40LE(D)TB
			Cooling Only	Cooling Only	Cooling Only	Cooling Only
Power		Phase, Lines, V	3, 4, 380-415	3, 4, 380-415	3, 4, 380-415	3, 4, 380-415
Capacity	Cooling	kW	65	74	114	130
		RT	18.5	21	32.4	37
Input Power	Cooling	kW	21.5	28.5	36.2	43
Efficiency	Cooling	W/W	3.02	2.60	3.15	3.02
IPLV		W/W	5.3	5.1	5.4	5.3
Sound Pressure		dBA	64	66	66	67
Compressor	Type	-	Scroll	Scroll	Scroll	Scroll
	No. of Compressor	EA	2	2	4	4
	Oil Type	-	PVE	PVE	PVE	PVE
	Oil charge	cc	1 400*2	1 400*2	1 400*4	1 400*4
Refrigerant	Type	-	R410A	R410A	R410A	R410A
	Amount of Charged	kg	6.5 kg X 2	6.5 kg X 2	6.5 kg X 4	6.5 kg X 4
Evaporator	Type	-	Shell&Tube	Shell&Tube	Shell&Tube	Shell&Tube
	Pressure drop	kPa	38.8	49.2	29.6	38.8
	Operating maximum pressure (Refrigerant / Water)	kg/cm ²	42/10	42/10	42/10	42/10
	Standard Flow (Cooling/Heating)	LPM	186	211	327	372
	Inlet/Outlet diameter (Water pipe)	-	50 A / 50 A	50 A / 50 A	65 A / 65 A	65 A / 65 A
Fan motor	Type	-	BLDC	BLDC	BLDC	BLDC
	No. of Fan	EA	2	2	4	4
	No. of Vanes	EA	6	6	6	6
	Air Flow Rate (@1 000 rpm)	CMM	246*2	246*2	246*4	246*4
	Motor power	W	900*2	900*2	900*4	900*4
Expansion device		-	EEV	EEV	EEV	EEV
Weight		kg	560	560	1 034	1 034
Dimension	W	mm	765	765	1 528	1 528
	H	mm	2 200	2 200	2 200	2 200
	D	mm	2 154	2 154	2 154	2 154
Footprint		m ² /RT	0.089	0.078	0.102	0.089
High Pressure		-	O	O	O	O
Anti Frost		-	O	O	O	O
Remote Controller		-	Modbus	Modbus	Modbus	Modbus
Outlet Temperature	Cooling	°C	4~20	4~20	4~20	4~20
Ambient Temperature	Cooling	°C	-15~48	-15~48	-15~48	-15~48
Earth Leakage Breaker		A	60	60	100	100
Guaranteed Load Capacity Range		%	20 ~ 100			

Notes:

1. Due to our policy of innovation some specifications may be changed without prior notification.
2. Capacities and Inputs are based on the following conditions
Cooling : Outdoor air temp. 35°C, Water inlet temp. 12°C, Water Outlet temp. 7°C

Inverter Scroll Chiller		Model	ACAH045LE(D)TB	ACAH050LE(D)TB	ACAH060LE(D)TB	ACAH067LE(D)TB
			CCAHA045LE(D)TB	CCAHA050LE(D)TB	CCAHA060LE(D)TB	CCAHA067LE(D)TB
			Cooling Only	Cooling Only	Cooling Only	Cooling Only
Power		Phase,Lines,V	3, 4, 380-415	3, 4, 380-415	3, 4, 380-415	3, 4, 380-415
Capacity	Cooling	kW	148	171	195	222
		RT	42.1	48.6	55.4	63.1
Input Power	Cooling	kW	56.9	54.3	64.6	85.4
Efficiency	Cooling	W/W	2.60	3.15	3.02	2.60
IPLV		W/W	5.1	5.4	5.3	5.1
Sound Pressure		dBA	69	68	69	71
Compressor	Type	-	Scroll	Scroll	Scroll	Scroll
	No. of Compressor	EA	4	6	6	6
	Oil Type	-	PVE	PVE	PVE	PVE
	Oil charge	cc	1 400*4	1 400*6	1 400*6	1 400*6
Refrigrant	Type	-	R410A	R410A	R410A	R410A
	Amount of Charged	kg	6.5 kg X 4	6.5 kg X 6	6.5 kg X 6	6.5 kg X 6
Evaporator	Type	-	Shell&Tube	Shell&Tube	Shell&Tube	Shell&Tube
	Pressure drop	kPa	49.2	29.6	38.8	49.2
	Operating maximum pressure (Refrigrant / Water)	kg/cm ²	42/10	42/10	42/10	42/10
	Standard Flow (Cooling/Heating)	LPM	422	491	558	633
	Inlet/Outlet diameter (Water pipe)	-	65 A / 65 A	65 A / 65 A	65 A / 65 A	65 A / 65 A
Fan motor	Type	-	BLDC	BLDC	BLDC	BLDC
	No. of Fan	EA	4	6	6	6
	No. of Vanes	EA	6	6	6	6
	Air Flow Rate (@1 000 rpm)	CMM	246*4	246*6	246*6	246*6
	Motor power	W	900*4	900*6	900*6	900*6
Expansion device		-	EEV	EEV	EEV	EEV
Weight		kg	1 034	1 522	1 522	1 522
Dimension	W	mm	1 528	2 291	2 291	2 291
	H	mm	2 200	2 200	2 200	2 200
	D	mm	2 154	2 154	2 154	2 154
Footprint		m ² /RT	0.078	0.101	0.089	0.078
High Pressure		-	O	O	O	O
Anti Frost		-	O	O	O	O
Remote Controller		-	Modbus	Modbus	Modbus	Modbus
Outlet Temperature	Cooling	°C	4~20	4~20	4~20	4~20
Ambient Temperature	Cooling	°C	-15~48	-15~48	-15~48	-15~48
Earth Leakage Breaker		A	125	125	125	200
Guaranteed Load Capacity Range		%	20 ~ 100			

Notes:

- Due to our policy of innovation some specifications may be changed without prior notification.
- Capacities and Inputs are based on the following conditions
Cooling : Outdoor air temp. 35°C, Water inlet temp. 12°C, Water Outlet temp. 7°C
- This product contains fluorinated greenhouse gases (R410A, GWP (Global warning potential) : 2 087.5)
t- CO2 eq = F-gas (kg) x GWP / 1 000

Specification

Inverter Scroll Chiller		Model	ACAH020HE(D)TB	ACAH023HE(D)TB	ACAH033HE(D)TB	ACAH040HE(D)TB
			Cooling Only	Cooling Only	Cooling Only	Cooling Only
Power		Phase, Lines, V	3, 3, 460	3, 3, 460	3, 3, 460	3, 3, 460
Capacity	Cooling	kW	65	74	114	130
		RT	18.5	21.0	32.4	37.0
Input Power	Cooling	kW	21.5	28.5	36.2	43
Efficiency	Cooling	W/W	3.02	2.60	3.15	3.02
IPLV		W/W	5.3	5.1	5.4	5.3
Sound Pressure		dBA	64	66	66	67
Compressor	Type	-	Scroll	Scroll	Scroll	Scroll
	No. of Compressor	EA	2	2	4	4
	Oil Type	-	PVE	PVE	PVE	PVE
	Oil charge	cc	1 400*2	1 400*2	1 400*4	1 400*4
Refrigrant	Type	-	R410A	R410A	R410A	R410A
	Amount of Charged	kg	6.5 kg X 2	6.5 kg X 2	6.5 kg X 4	6.5 kg X 4
Evaporator	Type	-	Shell&Tube	Shell&Tube	Shell&Tube	Shell&Tube
	Pressure drop	kPa	38.8	49.2	29.6	38.8
	Operating maximum pressure (Refrigrant / Water)	kg/cm ²	42/10	42/10	42/10	42/10
	Standard Flow	LPM	186	211	327	372
	Inlet/Outlet diameter (Water pipe)	-	50A/50A	50A/50A	65A/65A	65A/65A
Fan motor	Type	-	BLDC	BLDC	BLDC	BLDC
	No. of Fan	EA	2	2	4	4
	No. of Vanes	EA	6	6	6	6
	Air Flow Rate (@1 000 rpm)	CMM	246*2	246*2	246*4	246*4
	Motor power	W	900*2	900*2	900*4	900*4
Expansion device		-	EEV	EEV	EEV	EEV
Weight		kg	560	560	1 034	1 034
Dimension	W	mm	765	765	1 528	1 528
	H	mm	2 200	2 200	2 200	2 200
	D	mm	2 154	2 154	2 154	2 154
High Pressure		-	O	O	O	O
Anti Frost		-	O	O	O	O
Remote Controller		-	Modbus	Modbus	Modbus	Modbus
Outlet Temperature	Cooling	°C	4~20	4~20	4~20	4~20
Ambient Temperature	Cooling	°C	-15~48	-15~48	-15~48	-15~48
Earth Leakage Breaker		A	50	50	60	80
Guaranteed Load Capacity Range		%	20 ~ 100			

Notes:

- Due to our policy of innovation some specifications may be changed without prior notification.
- Capacities and Inputs are based on the following conditions
Cooling : Outdoor air temp. 35°C, Water inlet temp. 12°C, Water Outlet temp. 7°C
- This product contains fluorinated greenhouse gases (R410A, GWP (Global warning potential) : 2 087.5)
t- CO2 eq = F-gas (kg) x GWP / 1 000

Inverter Scroll Chiller		Model	ACAHO45HE(D)TB	ACAHO50HE(D)TB	ACAHO60HE(D)TB	ACAHO67HE(D)TB
			Cooling Only	Cooling Only	Cooling Only	Cooling Only
Power		Phase, Lines, V	3,3,460	3, 3, 460	3, 3, 460	3, 3, 460
Capacity	Cooling	kW	148	171	195	222
		RT	42.1	48.6	55.4	63.1
Input Power	Cooling	kW	56.9	54.3	64.6	85.4
Efficiency	Cooling	W/W	2.60	3.15	3.02	2.60
IPLV		W/W	5.1	5.4	5.3	5.1
Sound Pressure		dBA	69	68	69	71
Compressor	Type	-	Scroll	Scroll	Scroll	Scroll
	No. of Compressor	EA	4	6	6	6
	Oil Type	-	PVE	PVE	PVE	PVE
	Oil charge	cc	1 400*4	1 400*6	1 400*6	1 400*6
Refrigrant	Type	-	R410A	R410A	R410A	R410A
	Amount of Charged	kg	6.5 kg X 4	6.5 kg X 6	6.5 kg X 6	6.5 kg X 6
Evaporator	Type	-	Shell&Tube	Shell&Tube	Shell&Tube	Shell&Tube
	Pressure drop	kPa	49.2	29.6	38.8	49.2
	Operating maximum pressure (Refrigrant / Water)	kg/cm ²	42/10	42/10	42/10	42/10
	Standard Flow	LPM	422	491	558	633
	Inlet/Outlet diameter (Water pipe)	-	65A/65A	65A/65A	65A/65A	65A/65A
Fan motor	Type	-	BLDC	BLDC	BLDC	BLDC
	No. of Fan	EA	4	6	6	6
	No. of Vanes	EA	6	6	6	6
	Air Flow Rate (@1 000 rpm)	CMM	246*4	246*6	246*6	246*6
	Motor power	W	900*4	900*6	900*6	900*6
Expansion device		-	EEV	EEV	EEV	EEV
Weight		kg	1 034	1 522	1 522	1 522
Dimension	W	mm	1 528	2 291	2 291	2 291
	H	mm	2 200	2 200	2 200	2 200
	D	mm	2 154	2 154	2 154	2 154
High Pressure		-	O	O	O	O
Anti Frost		-	O	O	O	O
Remote Controller		-	Modbus	Modbus	Modbus	Modbus
Outlet Temperature	Cooling	°C	4~20	4~20	4~20	4~20
Ambient Temperature	Cooling	°C	-15~48	-15~48	-15~48	-15~48
Earth Leakage Breaker		A	100	100	125	150
Guaranteed Load Capacity Range		%	20 ~ 100			

Notes:

- Due to our policy of innovation some specifications may be changed without prior notification.
- Capacities and Inputs are based on the following conditions
Cooling : Outdoor air temp. 35°C, Water inlet temp. 12°C, Water Outlet temp. 7°C
- This product contains fluorinated greenhouse gases (R410A, GWP (Global warning potential) : 2 087.5)
t- CO2 eq = F-gas (kg) x GWP / 1 000

Specification

Inverter Scroll Chiller		Model	ACAH020VETB	ACAH033VETB	ACAH040VETB	ACAH050VETB	ACAH060VETB
			CCAH020VETB	CCAH033VETB	CCAH040VETB	CCAH050VETB	CCAH060VETB
			Cooling only	Cooling only	Cooling only	Cooling only	Cooling only
Power		Phase,Lines,V	3,3,208 - 230	3,3,208 - 230	3,3,208 - 230	3,3,208 - 230	3,3,208 - 230
			3,3,220	3,3,220	3,3,220	3,3,220	3,3,220
Capacity	Cooling	kW	65	114	130	171	195
		RT	18.5	32.4	37.0	48.6	55.4
Input Power	Cooling	kW	21.7	35.6	43.3	53.4	65.0
Efficiency	Cooling	W/W	3.00	3.10	3.00	3.10	3.00
IPLV		W/W	5	5.1	5.0	5.1	5.0
Sound Pressure		dBA	64	66	67	68	69
Compressor	Type	-	Scroll	Scroll	Scroll	Scroll	Scroll
	No. of Compressor	EA	2	4	4	6	6
	Oil Type	-	FW68D(PVE)	FW68D(PVE)	FW68D(PVE)	FW68D(PVE)	FW68D(PVE)
	Oil charge	cc	1400*2	1400*4	1400*4	1400*6	1400*6
Refrigerant	Type	-	R410A	R410A	R410A	R410A	R410A
Amount of Charged		kg	6.5 kg X 2	6.5 kg X 4	6.5 kg X 4	6.5 kg X 6	6.5 kg X 6
Evaporator	Type	-	Shell&Tube	Shell&Tube	Shell&Tube	Shell&Tube	Shell&Tube
	Pressure drop	kPa	38.8	29.6	38.8	29.6	38.8
	Operating maximum pressure (Refrigerant / Water)	kg/cm ²	42/10	42/10	42/10	42/10	42/10
	Standard Flow	LPM	186	327	372	491	558
	Water flow rate Max. / Min.	(L/min)	130 / 242	229 / 425	260 / 484	343 / 637	391 / 725
	Inlet/Outlet diameter (Water pipe)	-	50A/50A	65A/65A	65A/65A	65A/65A	65A/65A
Fan motor	Type	-	BLDC	BLDC	BLDC	BLDC	BLDC
	No. of Fan	EA	2	4	4	6	6
	No. of Vanes	EA	6 X 2	6 X 4	6 X 4	6 X 6	6 X 6
	Air Flow Rate (@1 000 rpm)	CMM	246*2	246*4	246*4	246*6	246*6
	Motor power	W	900*2	900*4	900*4	900*6	900*6
Expansion device		-	EEV	EEV	EEV	EEV	EEV
Weight		kg	560	1 034	1 034	1 522	1 522
Dimension	W	mm	765	1 528	1 528	2 291	2 291
	H	mm	2 200	2 200	2 200	2 200	2 200
	D	mm	2 154	2 154	2 154	2 154	2 154
High/Low Pressure		-	○	○	○	○	○
Anti Frost		-	○	○	○	○	○
Remote Controller		-	Modbus	Modbus	Modbus	Modbus	Modbus
Outlet Temperature	Cooling	°C	4~20	4~20	4~20	4~20	4~20
Ambient Temperature	Cooling	°C	-15~48	-15~48	-15~48	-15~48	-15~48
Earth Leakage Breaker		A	100	125	150	125 / 80	150 / 100
Guaranteed Load Capacity Range		%	20 ~ 100				

3. Functions

Classification	Function	ACAH Series
Reliability	High pressure sensor	O
	Low pressure sensor	O
	Over current protection equipment	O
	Discharge overheat temperature control	O
	Between phase protection equipment	O
	3 minutes delayed operation	O
	Freezing prevention	O
	Compression ratio limit	O
	Self diagnosis	O
Convenience	Automatic Re-start	O
	Remote control	O
	Low noise operation at night	O
	Automatic operation	O
	Schedule operation	O
Network	ModBus	O

Classification

O : Applicable, X : Non- applicable, - : Irrelevant

• 33, 40, 45 RT

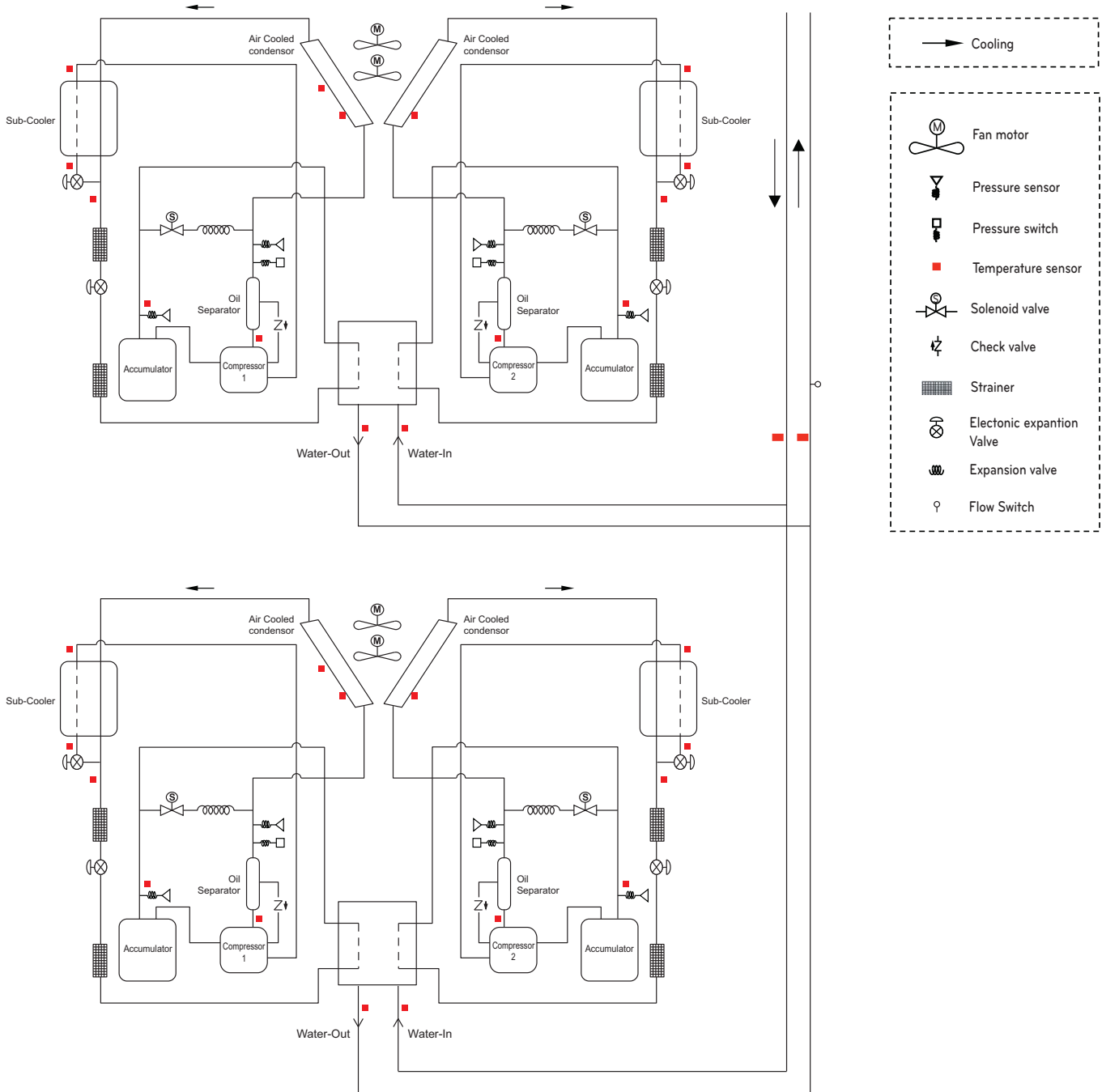

Piping Diagrams

• 50, 60, 67 RT

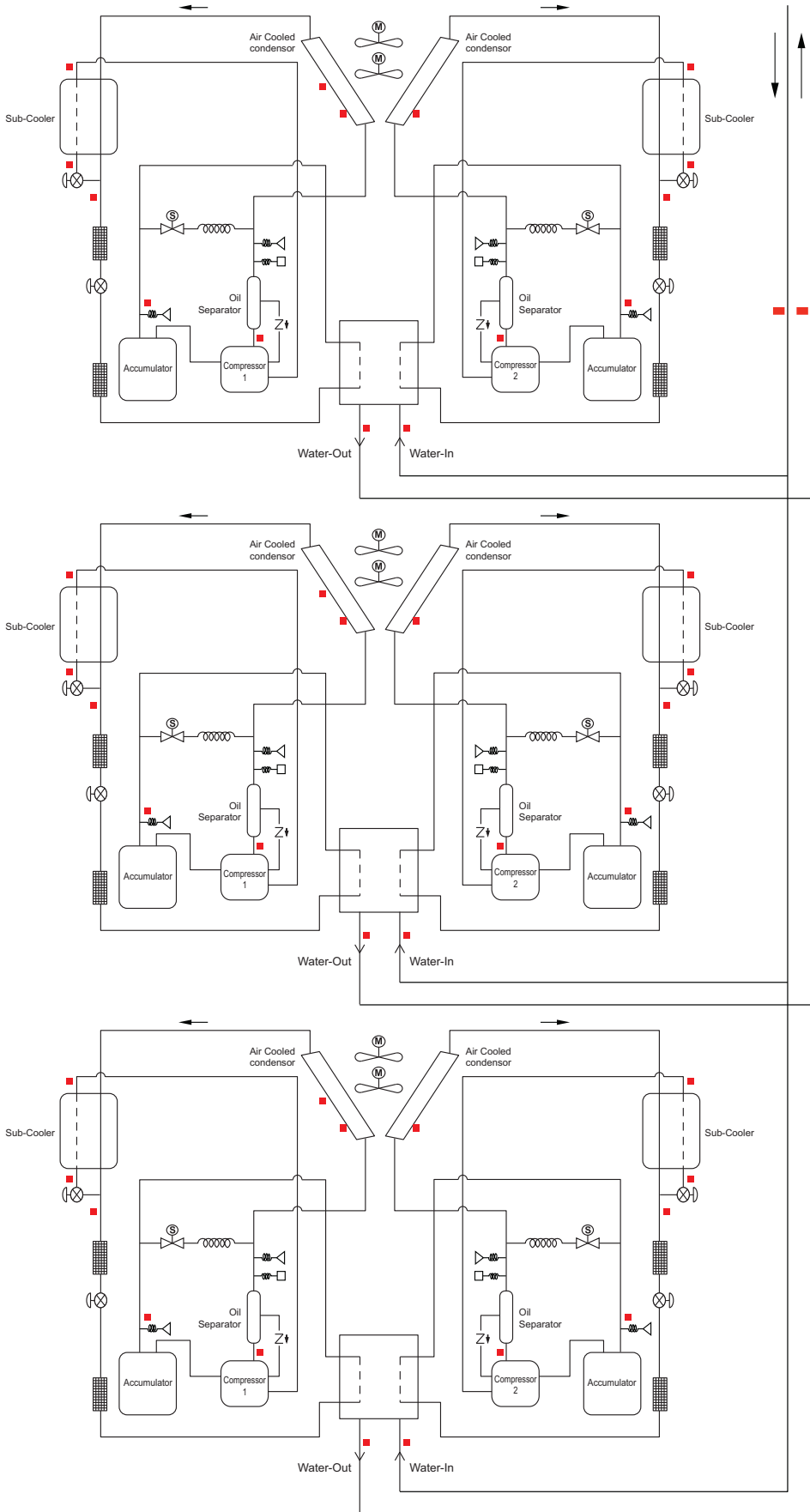

→ Cooling

- Fan motor
- Pressure sensor
- Pressure switch
- Temperature sensor
- Solenoid valve
- Check valve
- Strainer
- Electronic expansion Valve
- Expansion valve
- Flow Switch

5. Wiring Diagrams

■ 380 V Models

- 20, 23 RT, 33, 40, 45 RT (Main), 50, 60, 67 RT (Main)

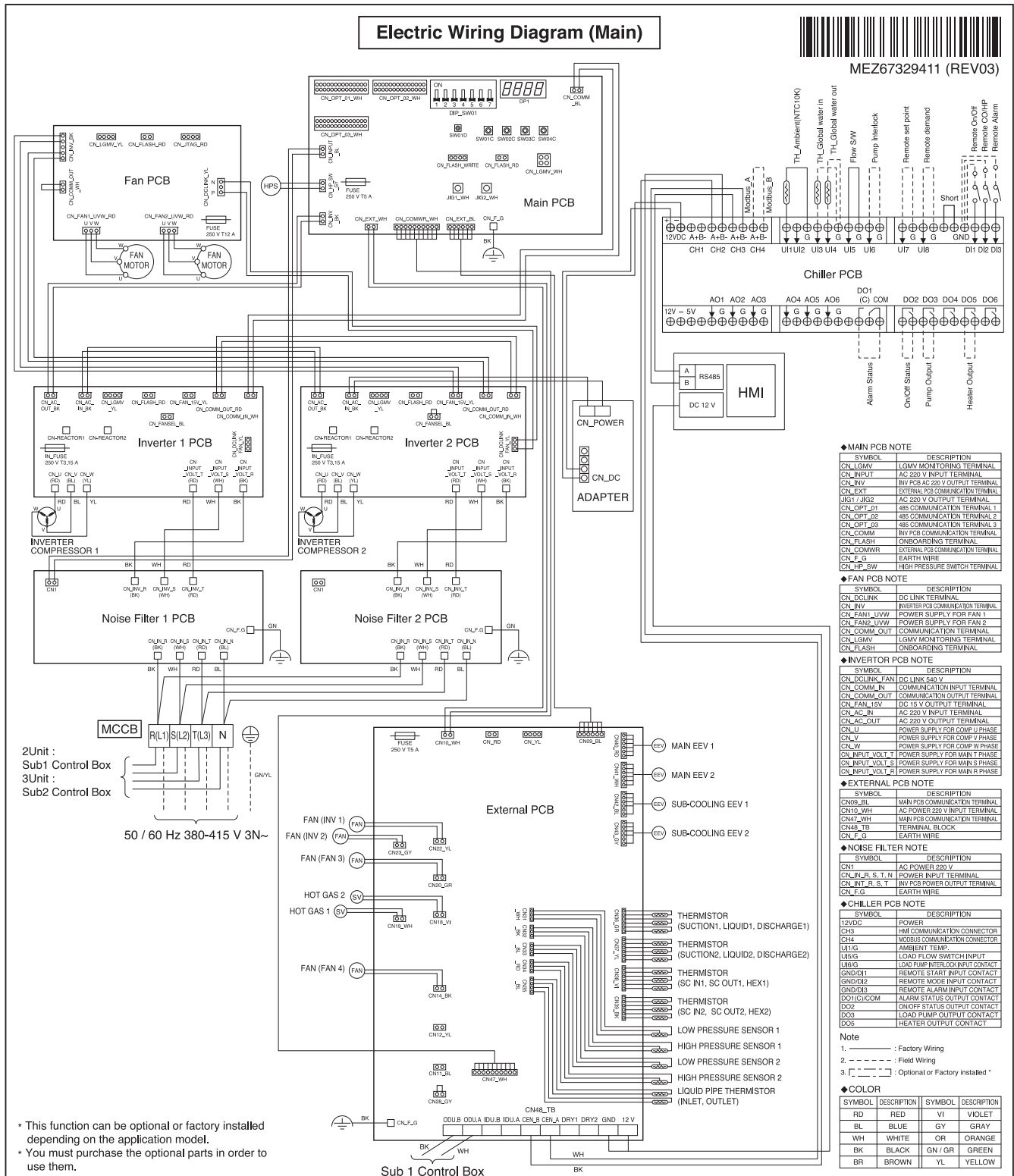

• 33, 40, 45 RT (Sub), 50, 60, 67 RT (Sub2)

Electric Wiring Diagram (2Unit : Sub / 3Unit : Sub2)



MEZ67329412 (REV03)

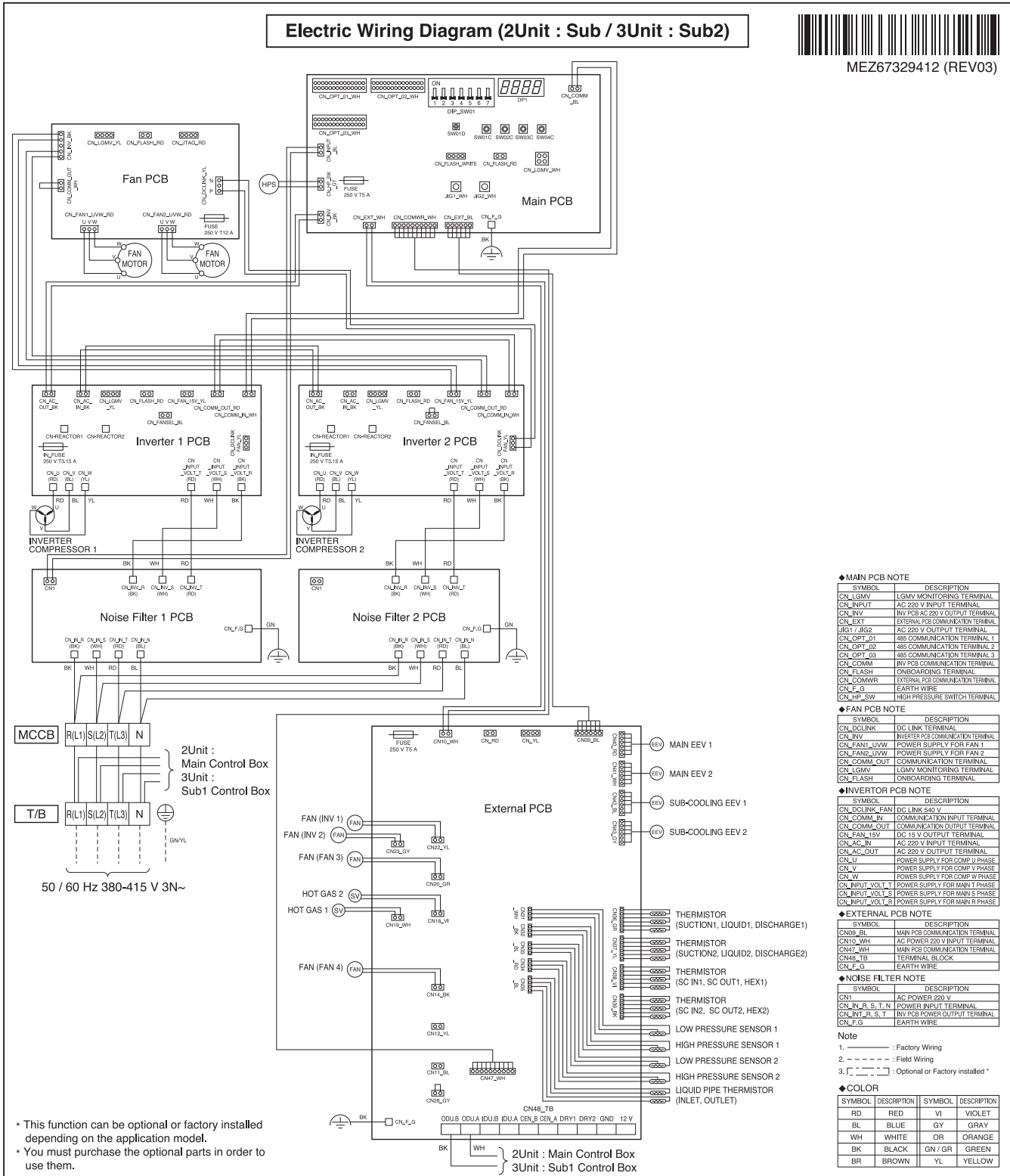

◆ MAIN PCB NOTE

SYMBOL	DESCRIPTION
CN_LGMV	LG MV MONITORING TERMINAL
CN_INPU	AC 220 V INPUT TERMINAL
CN_INV	INV PCB AC 220 V OUTPUT TERMINAL
CN_EXT	EXTERNAL PCB COMMUNICATION TERMINAL
CN_FLASH_WRITE	AC 220 V OUTPUT TERMINAL
CN_FLASH_READ	AC 220 V OUTPUT TERMINAL
CN_GARY_WH	AC 220 V OUTPUT TERMINAL
CN_OPT_01	485 COMMUNICATION TERMINAL 1
CN_OPT_02	485 COMMUNICATION TERMINAL 2
CN_OPT_03	485 COMMUNICATION TERMINAL 3
CN_COMM	INV PCB COMMUNICATION TERMINAL
CN_FLASH	ONBOARDING TERMINAL
CN_COMMWR	EXTERNAL PCB COMMUNICATION TERMINAL
CN_F_G	EARTH WIRE
CN_HP_SW	HIGH PRESSURE SWITCH TERMINAL

◆ FAN PCB NOTE

SYMBOL	DESCRIPTION
CN_DCLINK_FAN	DC LINK TERMINAL
CN_INV	INVERTER PCB COMMUNICATION TERMINAL
CN_FAN1_UVW	POWER SUPPLY FOR FAN 1
CN_FAN2_UVW	POWER SUPPLY FOR FAN 2
CN_COMM_OUT	COMMUNICATION TERMINAL
CN_LGMV	LG MV MONITORING TERMINAL
CN_FLASH	ONBOARDING TERMINAL

◆ INVERTER PCB NOTE

SYMBOL	DESCRIPTION
CN_DCLINK_FAN	DC LINK TERMINAL
CN_COMM_IN	COMMUNICATION INPUT TERMINAL
CN_COMM_OUT	COMMUNICATION OUTPUT TERMINAL
CN_FAN1_LSV	DC 15 V OUTPUT TERMINAL
CN_AC_IN	AC 220 V INPUT TERMINAL
CN_AC_OUT	AC 220 V OUTPUT TERMINAL
CN_U	POWER SUPPLY FOR COMP U PHASE
CN_V	POWER SUPPLY FOR COMP V PHASE
CN_W	POWER SUPPLY FOR COMP W PHASE
CN_INPU	AC 220 V INPUT TERMINAL
CN_INPU_V	POWER SUPPLY FOR MAIN U PHASE
CN_INPU_V	POWER SUPPLY FOR MAIN V PHASE
CN_INPU_V	POWER SUPPLY FOR MAIN R PHASE

◆ EXTERNAL PCB NOTE

SYMBOL	DESCRIPTION
CN9_B	MAIN PCB COMMUNICATION TERMINAL
CN10_WH	AC POWER 220 V INPUT TERMINAL
CN17_WH	MAIN PCB COMMUNICATION TERMINAL
CN18_TB	TERMINAL BLOCK
CN_F_G	EARTH WIRE

◆ NOISE FILTER NOTE

SYMBOL	DESCRIPTION
CNT	AC POWER 220 V
CN_IN_U, S, T, N	POWER INPUT TERMINAL
CN_IN_T, B, S, T	INV PCB POWER OUTPUT TERMINAL
CN_F_G	EARTH WIRE

Note

- Factory Wiring
- Field Wiring
- Optional or Factory installed *

◆ COLOR

SYMBOL	DESCRIPTION	SYMBOL	DESCRIPTION
RD	RED	VI	VIOLET
BL	BLUE	GY	GRAY
WH	WHITE	OR	ORANGE
BK	BLACK	GN / GR	GREEN
BR	BROWN	YL	YELLOW

* This function can be optional or factory installed depending on the application model.
 * You must purchase the optional parts in order to use them.

• 50, 60, 67 RT (Sub1)

Electric Wiring Diagram (3Unit : Sub1)



MEZ67329413 (REV03)

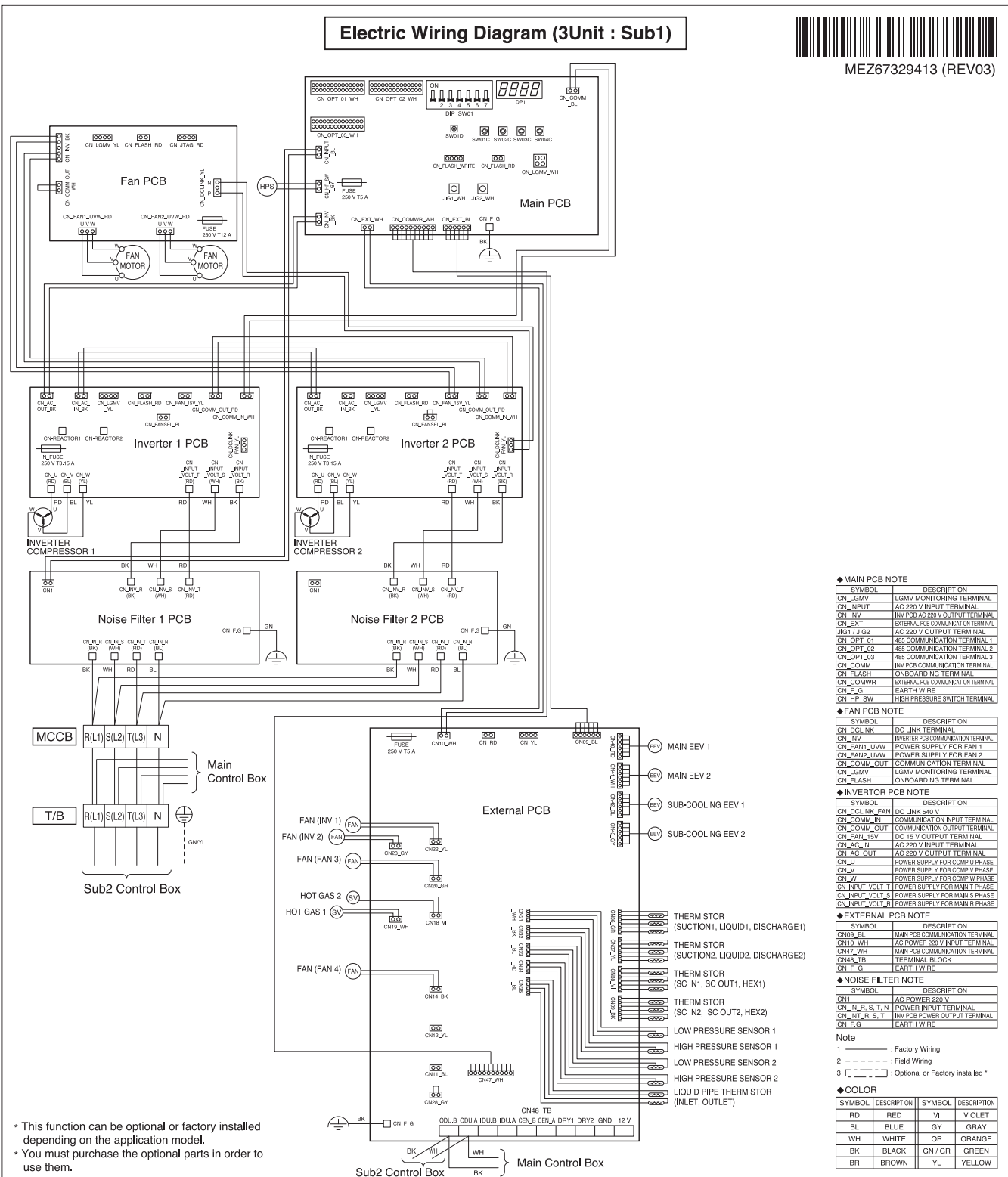

◆MAIN PCB NOTE

SYMBOL	DESCRIPTION
CN_LGMV	LGMV MONITORING TERMINAL
CN_INPUT	AC 220 V INPUT TERMINAL
CN_INV	INV PCB AC 220 V OUTPUT TERMINAL
CN_EXT	EXTERNAL PCB COMMUNICATION TERMINAL
JG11 / JG2	AC 220 V OUTPUT TERMINAL
CN_OPT_01	48S COMMUNICATION TERMINAL 1
CN_OPT_02	48S COMMUNICATION TERMINAL 2
CN_OPT_03	48S COMMUNICATION TERMINAL 3
CN_COMM	INV PCB COMMUNICATION TERMINAL
CN_FLASH	ONBOARDING TERMINAL
CN_COMMW	EXTERNAL PCB COMMUNICATION TERMINAL
CN_F_G	EARTH WIRE
CN_HPS_SW	HIGH PRESSURE SWITCH TERMINAL

◆FAN PCB NOTE

SYMBOL	DESCRIPTION
CN_DCLINK	DC LINK TERMINAL
CN_INV	INVERTER PCB COMMUNICATION TERMINAL
CN_FAN_UVW	POWER SUPPLY FOR FAN 1
CN_FAN_UVW	POWER SUPPLY FOR FAN 2
CN_COMM_OUT	COMMUNICATION OUTPUT TERMINAL
CN_LGMV	LGMV MONITORING TERMINAL
CN_FLASH	ONBOARDING TERMINAL

◆INVERTOR PCB NOTE

SYMBOL	DESCRIPTION
CN_DCLINK_FAN	DC LINK 540 V
CN_COMM_IN	COMMUNICATION INPUT TERMINAL
CN_COMM_OUT	COMMUNICATION OUTPUT TERMINAL
CN_FAN_15V	DC 15 V OUTPUT TERMINAL
CN_AC_IN	AC 220 V INPUT TERMINAL
CN_AC_OUT	AC 220 V OUTPUT TERMINAL
CN_U	POWER SUPPLY FOR COMP U PHASE
CN_V	POWER SUPPLY FOR COMP V PHASE
CN_W	POWER SUPPLY FOR COMP W PHASE
CN_INPUT_VOLT_T	POWER SUPPLY FOR MAIN T PHASE
CN_INPUT_VOLT_S	POWER SUPPLY FOR MAIN S PHASE
CN_INPUT_VOLT_R	POWER SUPPLY FOR MAIN R PHASE

◆EXTERNAL PCB NOTE

SYMBOL	DESCRIPTION
CN09_BL	MAIN PCB COMMUNICATION TERMINAL
CN10_WH	AC POWER 220 V INPUT TERMINAL
CN47_WH	MAIN PCB COMMUNICATION TERMINAL
CN48_TB	TERMINAL BLOCK
CN_F_G	EARTH WIRE

◆NOISE FILTER NOTE

SYMBOL	DESCRIPTION
CN1	AC POWER 220 V
CN_R_N_S_T_N	POWER INPUT TERMINAL
CN_INTR_S_T	INV PCB POWER OUTPUT TERMINAL
CN_F_G	EARTH WIRE

Note
 1. ——— : Factory Wiring
 2. - - - - : Field Wiring
 3. [] : Optional or Factory installed *

◆COLOR

SYMBOL	DESCRIPTION	SYMBOL	DESCRIPTION
RD	RED	VI	VIOLET
BL	BLUE	GY	GRAY
WH	WHITE	OR	ORANGE
BK	BLACK	GN / GR	GREEN
BR	BROWN	YL	YELLOW

* This function can be optional or factory installed depending on the application model.
 * You must purchase the optional parts in order to use them.

■ 460 V Models

• 20, 23 RT, 33, 40, 45 RT (Main), 50, 60, 67 RT (Main)

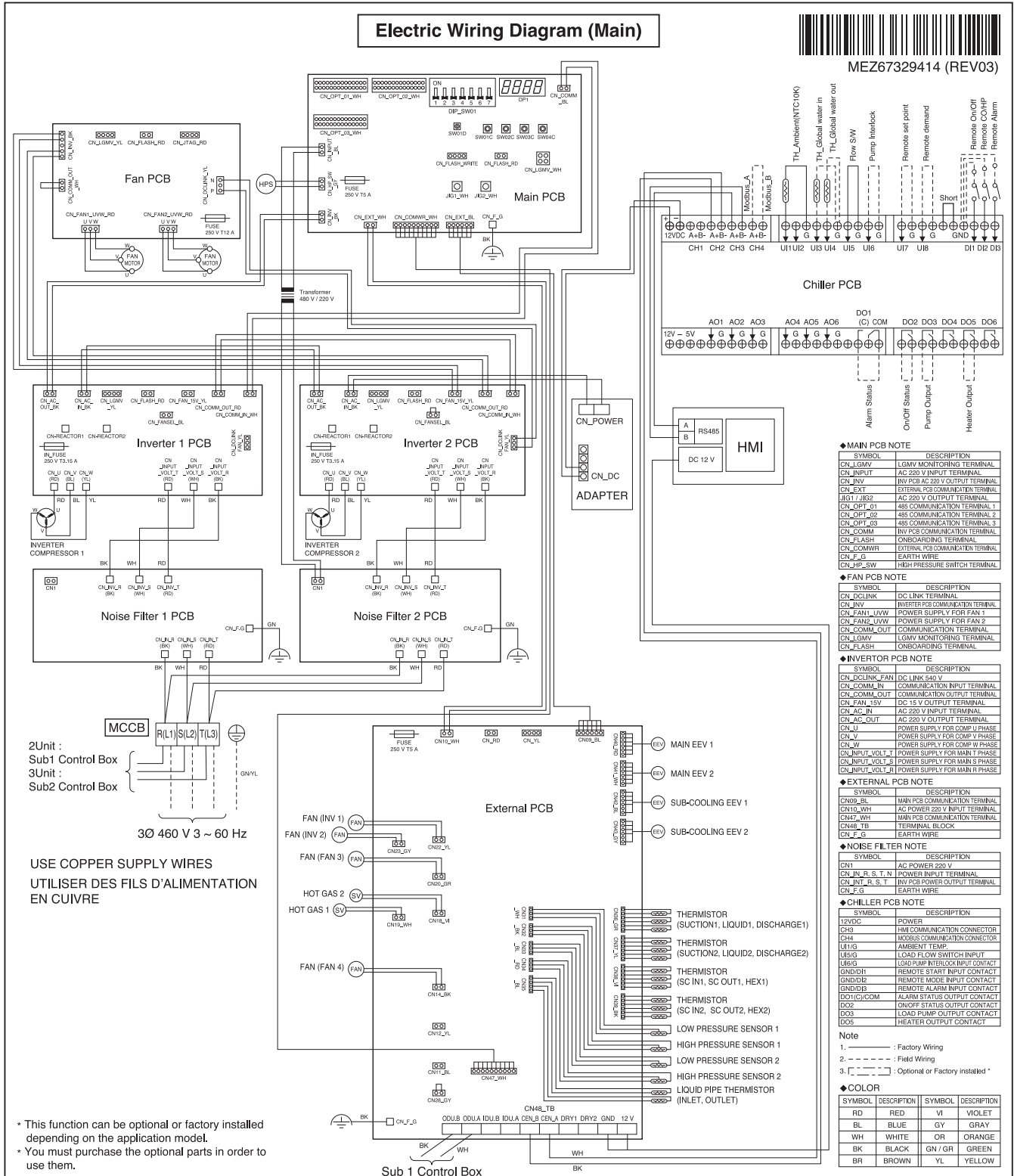

• 33, 40, 45 RT (Sub), 50, 60, 67 RT (Sub2)

Electric Wiring Diagram (2Unit : Sub/3Unit : Sub2)



MEZ67329415 (REV03)

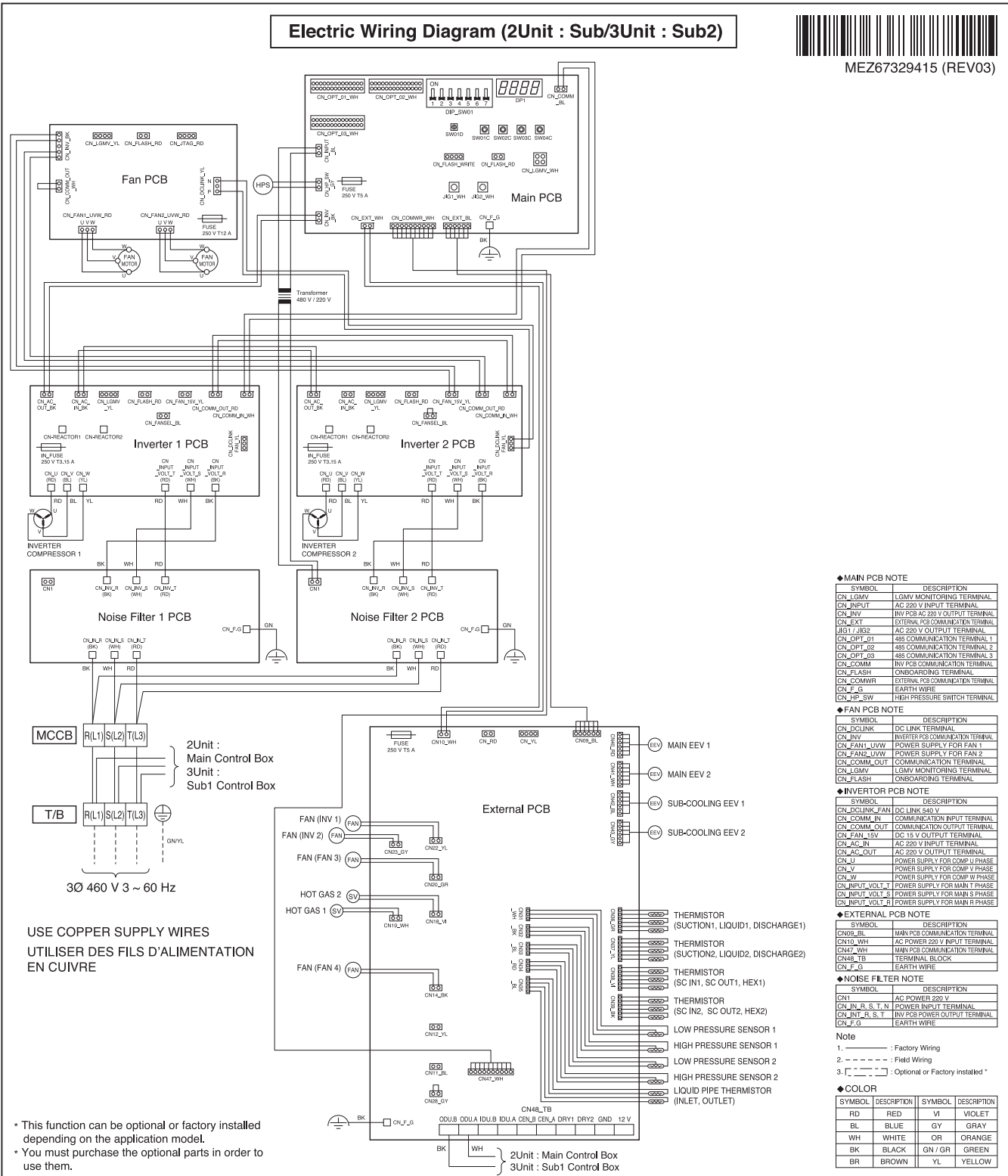

◆MAIN PCB NOTE

SYMBOL	DESCRIPTION
CN_LGMV	LGVM MONITORING TERMINAL
CN_INPT	AC 220 V INPUT TERMINAL
CN_INV	INV PCB AC 220 V OUTPUT TERMINAL
CN_EXT	EXTERNAL PCB COMMUNICATION TERMINAL
ES11 JS22	AC 220 V OUTPUT TERMINAL
CN_OPT_01	48S COMMUNICATION TERMINAL 1
CN_OPT_02	48S COMMUNICATION TERMINAL 2
CN_OPT_03	48S COMMUNICATION TERMINAL 3
CN_COMM	INV PCB COMMUNICATION TERMINAL
CN_FLASH	ONBOARDING TERMINAL
CN_COMMW	EXTERNAL PCB COMMUNICATION TERMINAL
CN_F_G	EARTH WIRE
CN_HP_SW	HIGH PRESSURE SWITCH TERMINAL

◆FAN PCB NOTE

SYMBOL	DESCRIPTION
CN_DCLINK	DC LINK TERMINAL
CN_INV	INVERTER PCB COMMUNICATION TERMINAL
CN_FAN1_UVW	POWER SUPPLY FOR FAN 1
CN_FAN2_UVW	POWER SUPPLY FOR FAN 2
CN_COMM_OUT	COMMUNICATION TERMINAL 3
CN_LGMV	LGVM MONITORING TERMINAL
CN_FLASH	ONBOARDING TERMINAL

◆INVERTOR PCB NOTE

SYMBOL	DESCRIPTION
CN_DCLINK_FAN	DC LINK 540 V
CN_COMM_IN	COMMUNICATION INPUT TERMINAL
CN_COMM_OUT	COMMUNICATION OUTPUT TERMINAL
CN_FAN_INV	DC 15 V OUTPUT TERMINAL
CN_AC_IN	AC 220 V INPUT TERMINAL
CN_AC_OUT	AC 220 V OUTPUT TERMINAL
CN_V	POWER SUPPLY FOR COMP V PHASE
CN_W	POWER SUPPLY FOR COMP W PHASE
CN_INPT_VOLT_1	POWER SUPPLY FOR MAIN T PHASE
CN_INPT_VOLT_S	POWER SUPPLY FOR MAIN S PHASE
CN_INPT_VOLT_R	POWER SUPPLY FOR MAIN R PHASE

◆EXTERNAL PCB NOTE

SYMBOL	DESCRIPTION
CN09_BK	MAIN PCB COMMUNICATION TERMINAL
CN10_WH	AC POWER 220 V INPUT TERMINAL
CN47_WH	MAIN PCB COMMUNICATION TERMINAL
CN48_TB	TERMINAL BLOCK
CN_F_G	EARTH WIRE

◆NOISE FILTER NOTE

SYMBOL	DESCRIPTION
CN1	AC POWER 220 V
CN_INL_R_S_T_N	POWER INPUT TERMINAL
CN_INT_R_S_T	INV PCB POWER OUTPUT TERMINAL
CN_F_G	EARTH WIRE

Note

- 1. ——— : Factory Wiring
- 2. - - - - - : Field Wiring
- 3. [] : Optional or Factory installed *

◆COLOR

SYMBOL	DESCRIPTION	SYMBOL	DESCRIPTION
RD	RED	VI	VIOLET
BL	BLUE	GY	GRAY
WH	WHITE	OR	ORANGE
BK	BLACK	GN / GR	GREEN
BR	BROWN	YL	YELLOW

• 50, 60, 67 RT (Sub1)

Electric Wiring Diagram (3Unit : Sub1)



MEZ67329416 (REV03)

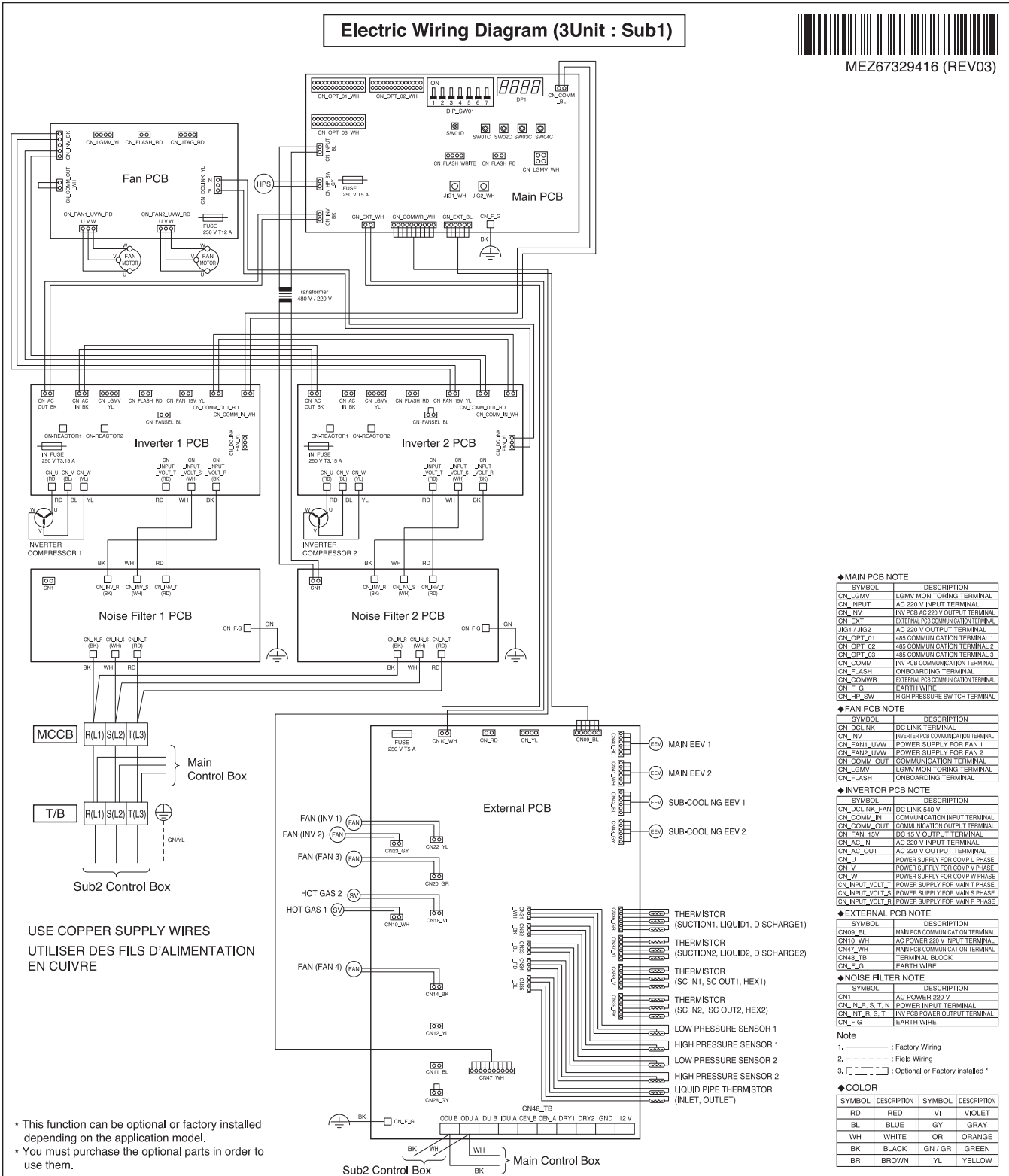

◆ MAIN PCB NOTE

SYMBOL	DESCRIPTION
CN_LGMV	LGMV MONITORING TERMINAL
CN_INPUT	AC 220 V INPUT TERMINAL
CN_INV	INV PCB AC 220 V OUTPUT TERMINAL
CN_EXT	EXTERNAL PCB COMMUNICATION TERMINAL
TEST_ILG2	AC 220 V OUTPUT TERMINAL
CN_OPT_01	48S COMMUNICATION TERMINAL 1
CN_OPT_02	48S COMMUNICATION TERMINAL 2
CN_OPT_03	48S COMMUNICATION TERMINAL 3
CN_COMM	INV PCB COMMUNICATION TERMINAL
CN_FLASH	ONBOARDING TERMINAL
CN_COMMWR	EXTERNAL PCB COMMUNICATION TERMINAL
CN_F_G	EARTH WIRE
CN_HP_SW	HIGH PRESSURE SWITCH TERMINAL

◆ FAN PCB NOTE

SYMBOL	DESCRIPTION
CN_DCLINK	DC LINK TERMINAL
CN_INV	INVERTER PCB COMMUNICATION TERMINAL
CN_FAN1_UVW	POWER SUPPLY FOR FAN 1
CN_FAN2_UVW	POWER SUPPLY FOR FAN 2
CN_COMM_OUT	COMMUNICATION TERMINAL
CN_LGMV	LGMV MONITORING TERMINAL
CN_FLASH	ONBOARDING TERMINAL

◆ INVERTER PCB NOTE

SYMBOL	DESCRIPTION
CN_DCLINK_IN	DC LINK 540 V TERMINAL
CN_COMM_OUT	COMMUNICATION OUTPUT TERMINAL
CN_FAN_15V	DC 15 V OUTPUT TERMINAL
CN_AC_IN	AC 220 V INPUT TERMINAL
CN_AC_OUT	AC 220 V OUTPUT TERMINAL
CN_U	POWER SUPPLY FOR COMP U PHASE
CN_V	POWER SUPPLY FOR COMP V PHASE
CN_W	POWER SUPPLY FOR COMP W PHASE
CN_INPUT_VOLT_1	POWER SUPPLY FOR MAIN S PHASE
CN_INPUT_VOLT_2	POWER SUPPLY FOR MAIN S PHASE
CN_INPUT_VOLT_3	POWER SUPPLY FOR MAIN S PHASE
CN_INPUT_VOLT_R	POWER SUPPLY FOR MAIN R PHASE

◆ EXTERNAL PCB NOTE

SYMBOL	DESCRIPTION
CN09_BL	MAIN PCB COMMUNICATION TERMINAL
CN10_WH	AC POWER 220 V INPUT TERMINAL
CN47_WH	MAIN PCB COMMUNICATION TERMINAL
CN08_TB	TERMINAL BLOCK
CN_F_G	EARTH WIRE

◆ NOISE FILTER NOTE

SYMBOL	DESCRIPTION
CN1	AC POWER 220 V
CN_IN_R_S_T_N	POWER INPUT TERMINAL
CN_IN_B_S_T	INV PCB POWER OUTPUT TERMINAL
CN_F_G	EARTH WIRE

Note
 1. - - - - - Factory Wiring
 2. - - - - - Field Wiring
 3. [] - - - - - Optional or Factory installed *

◆ COLOR

SYMBOL	DESCRIPTION	SYMBOL	DESCRIPTION
RD	RED	VI	VIOLET
BL	BLUE	GY	GRAY
WH	WHITE	OR	ORANGE
BK	BLACK	GN/GR	GREEN
BR	BROWN	YL	YELLOW

■ 220 V Models

• 20, 23 RT, 33, 40, 45 RT (Main), 50, 60, 67 RT (Main)

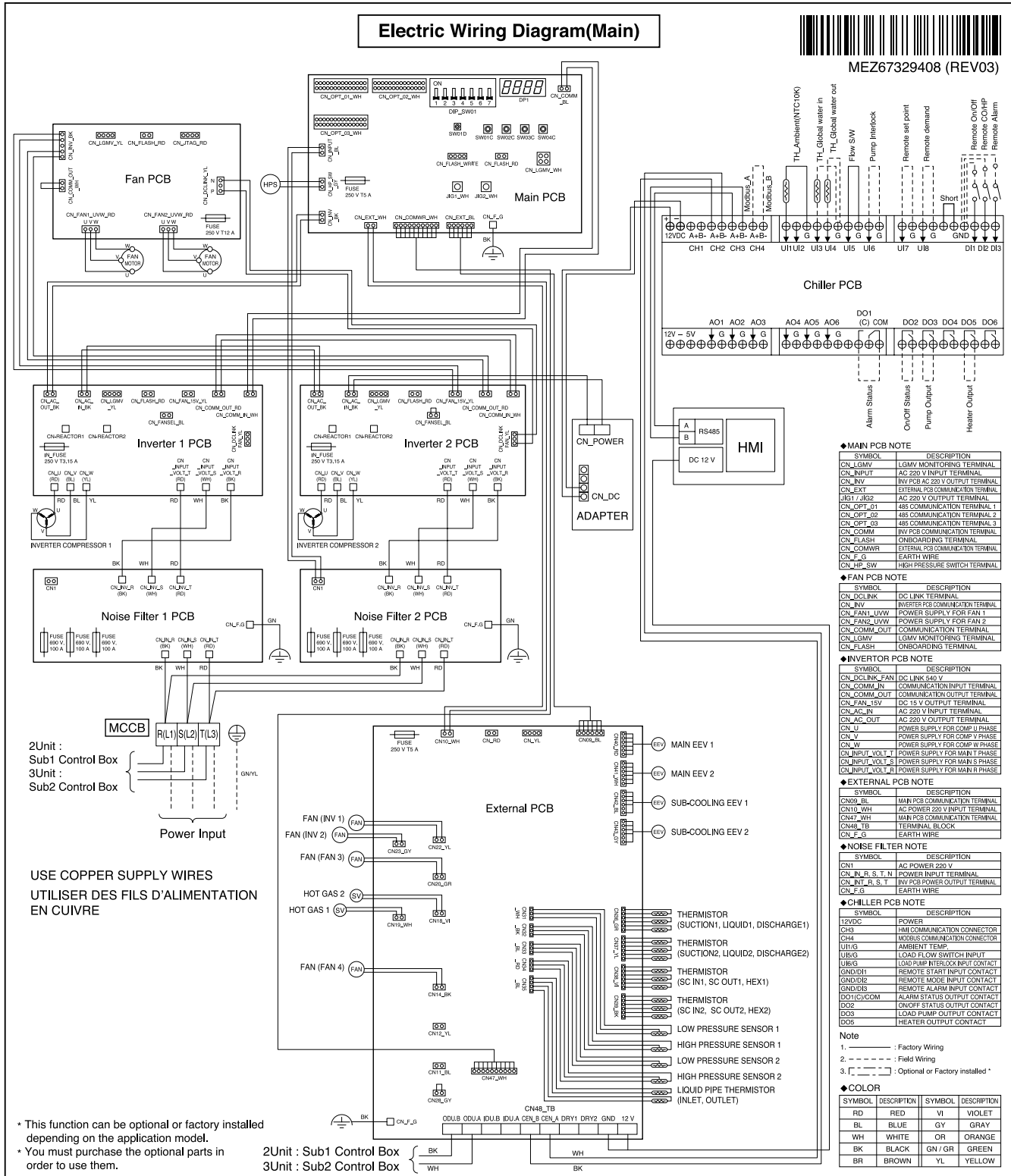

• 33, 40, 45 RT (Sub), 50, 60, 67 RT (Sub)

Electric Wiring Diagram(Sub 1, 2)



MEZ67329409 (REV03)

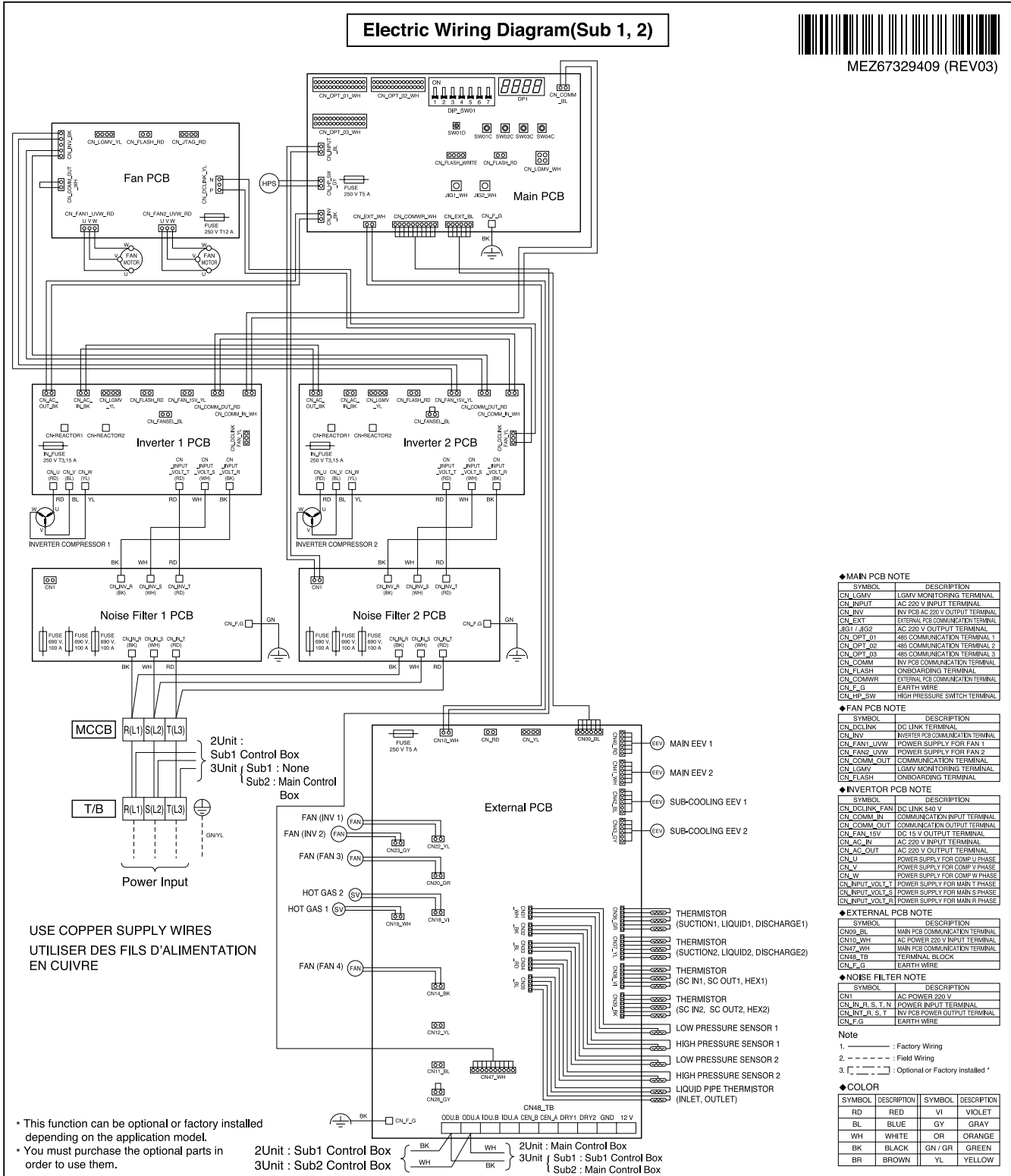

• Chiller Main PCB

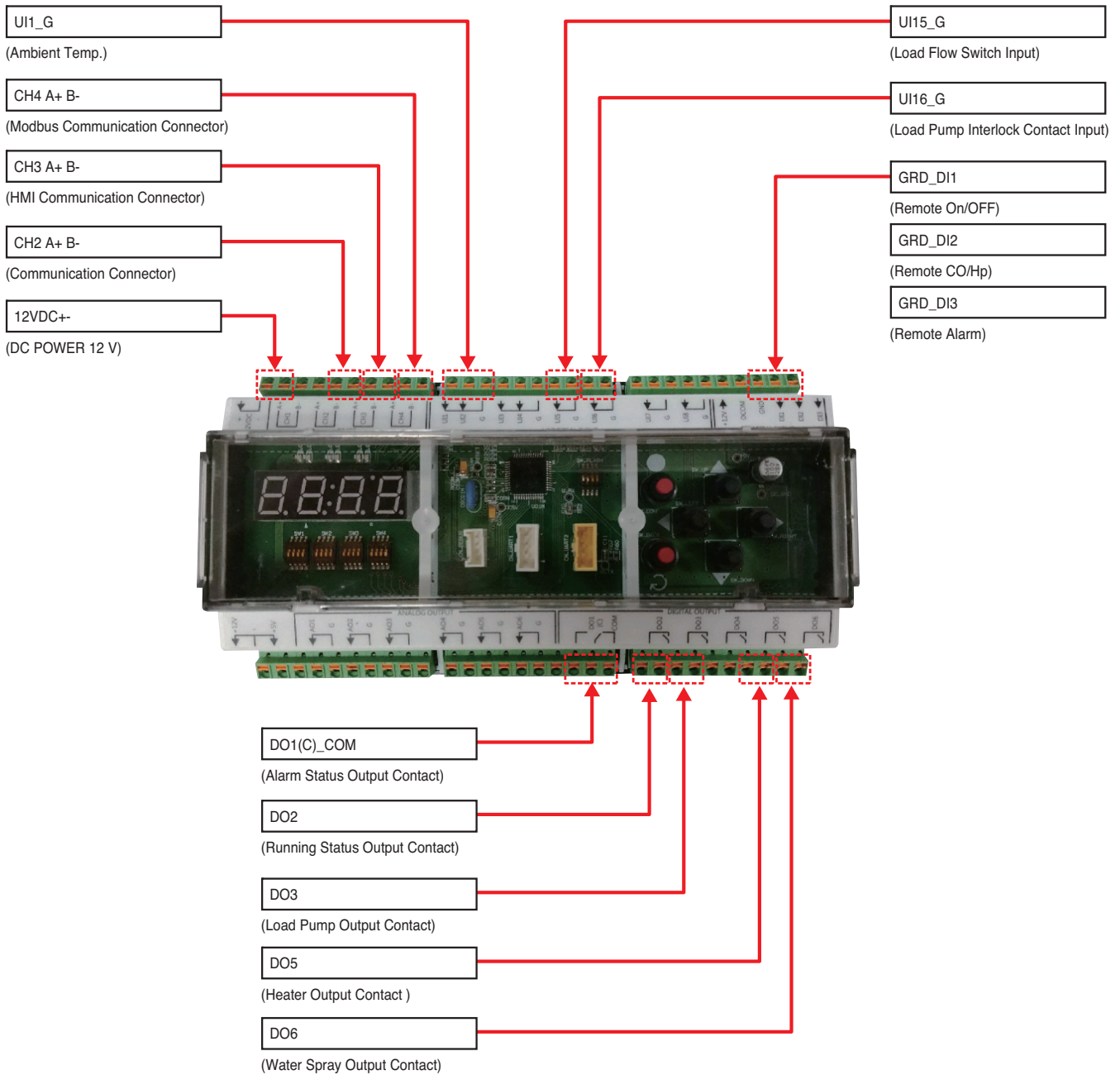

• ADAPTER

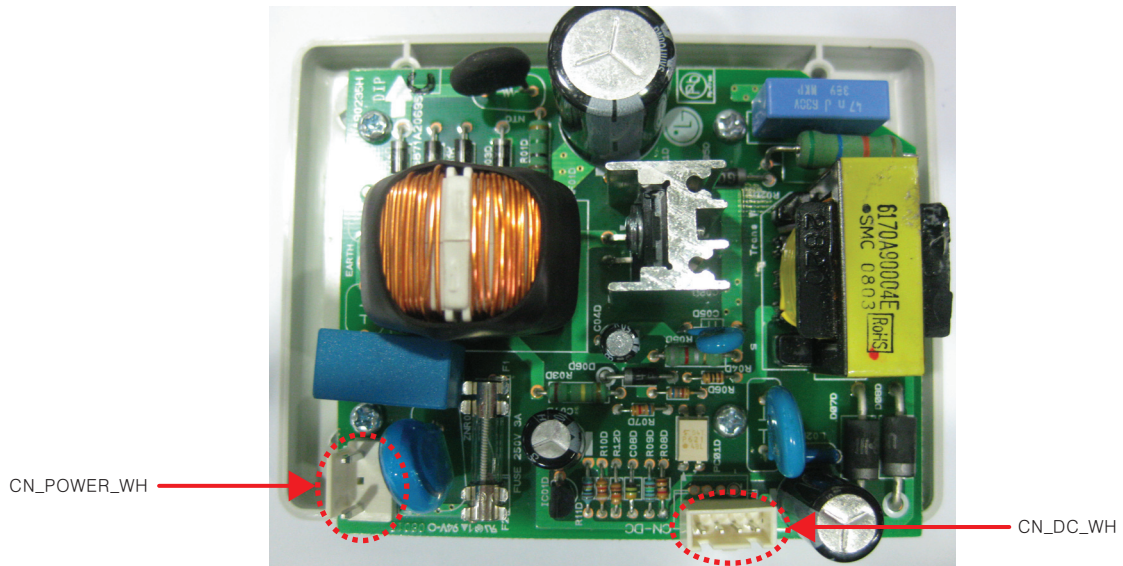

• Cycle Main PCB

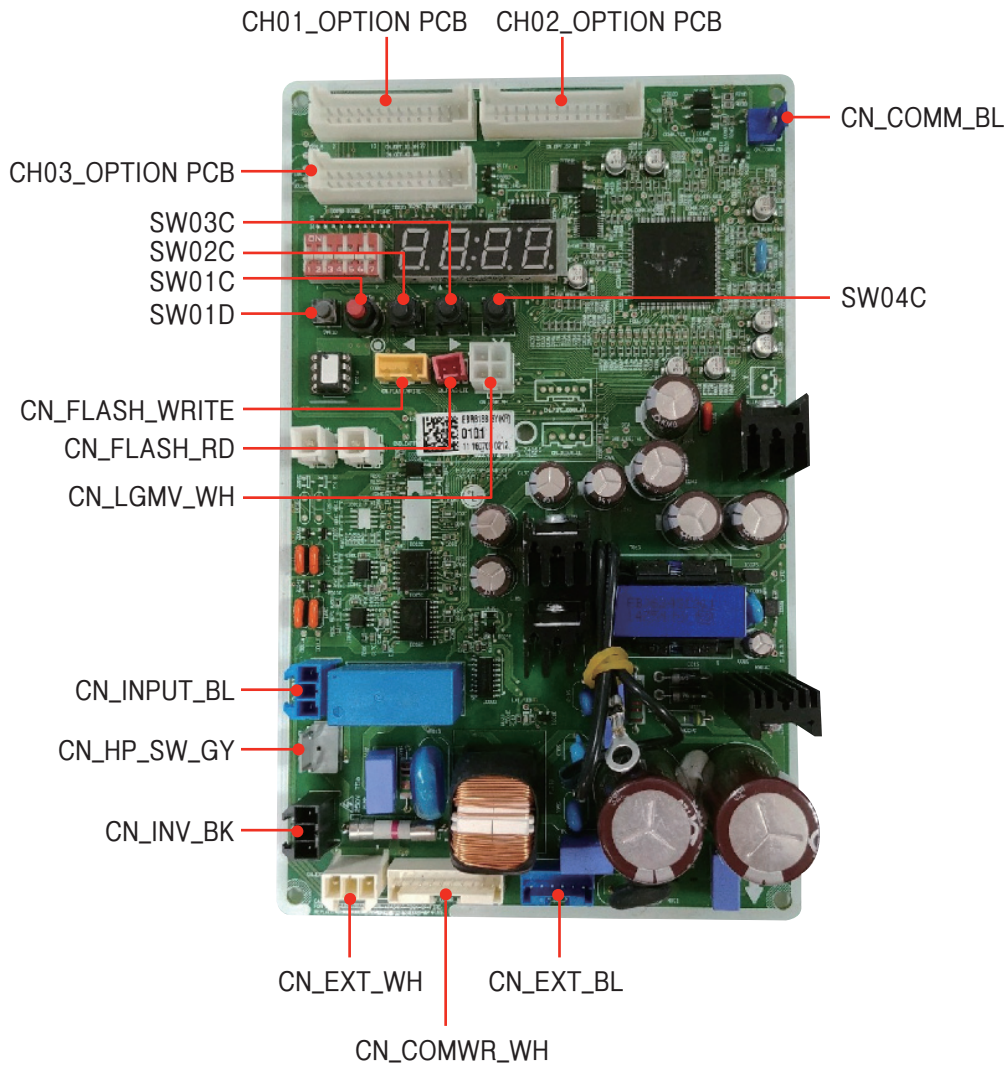

• Cycle External PCB

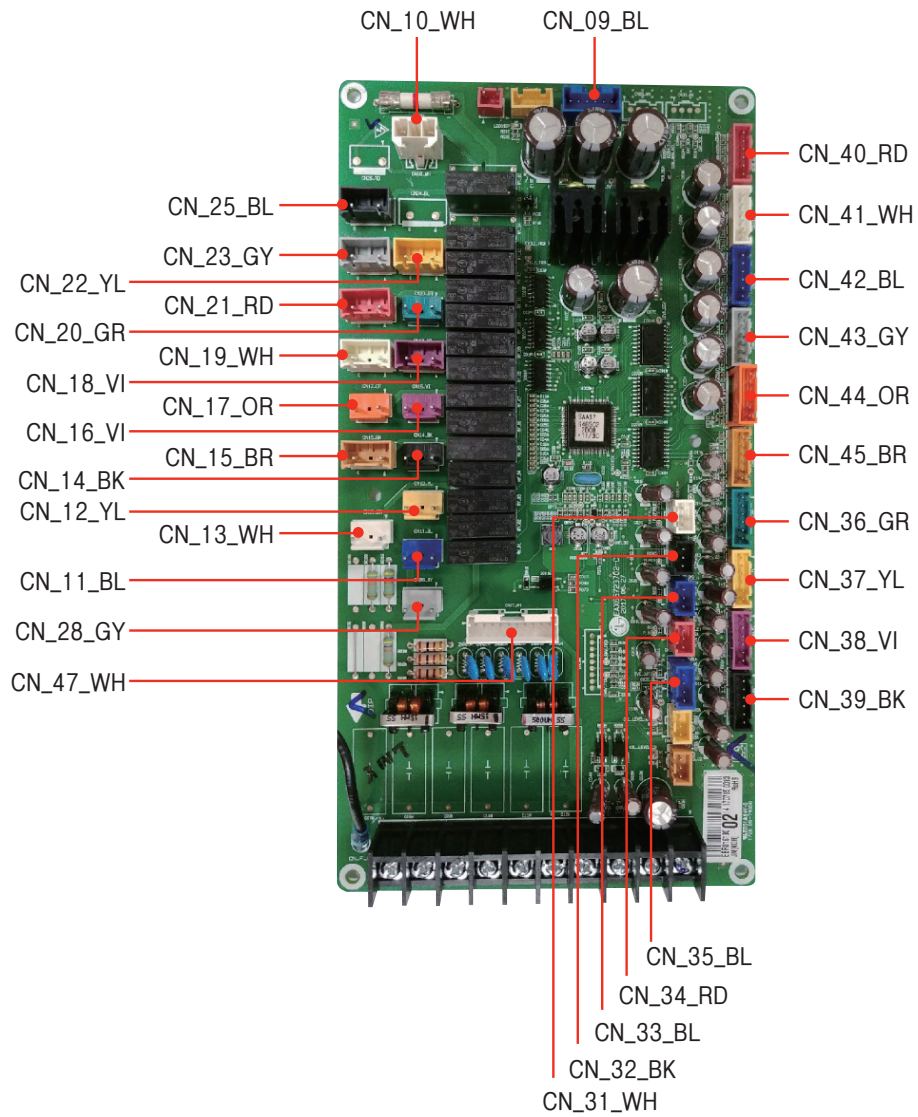

• Noise Filter PCB

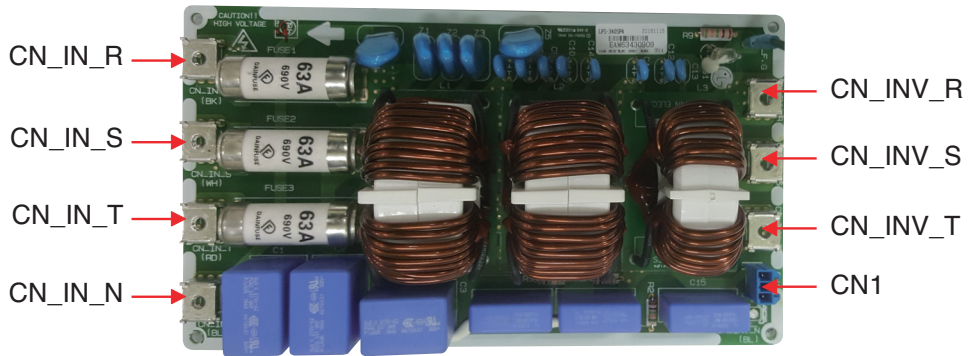

• Fan PCB

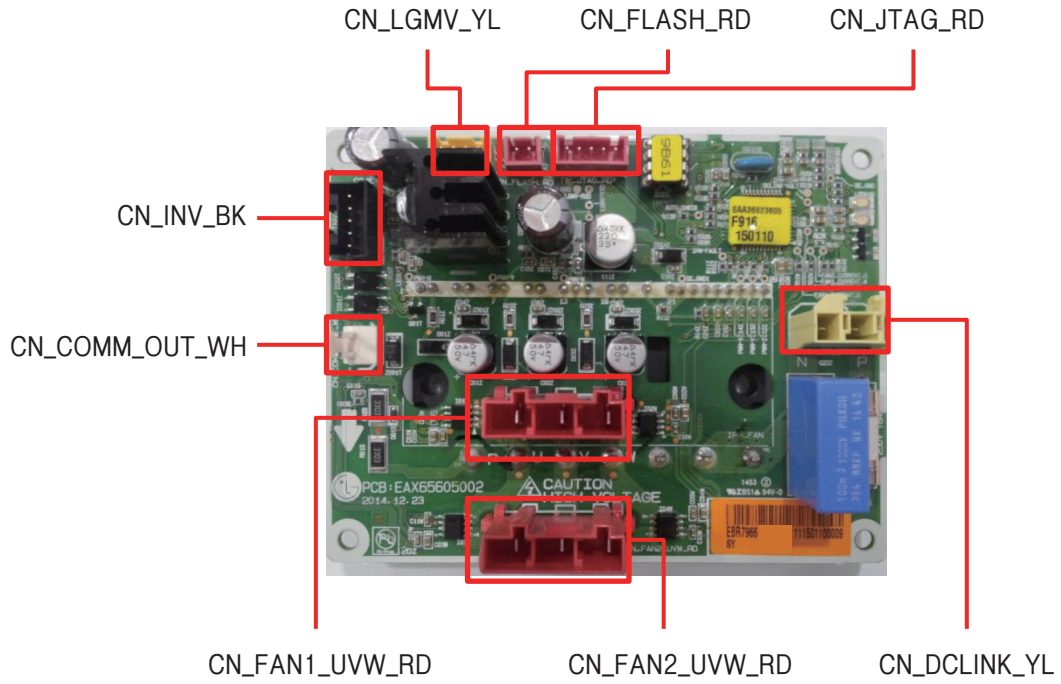

• Inverter PCB

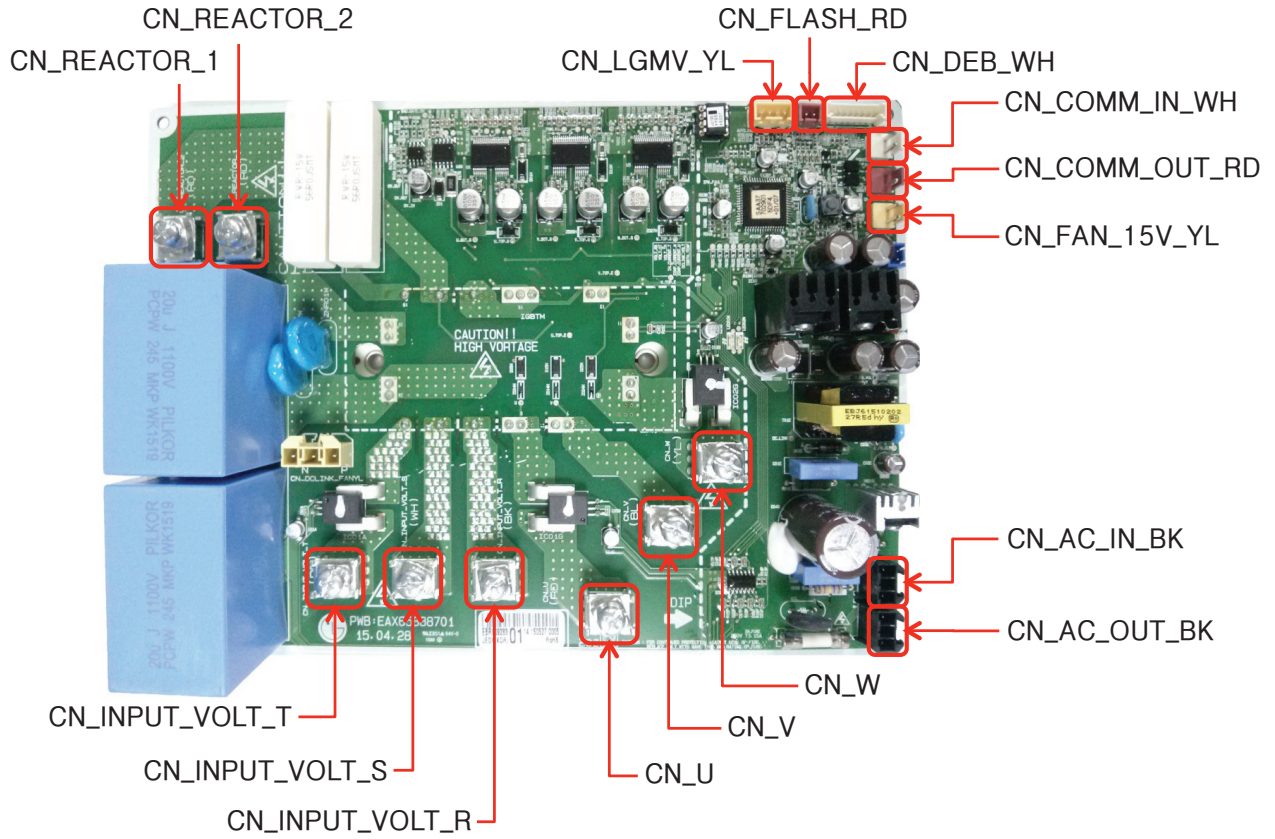

6. Exploded View

6.1 Fan Assembly

20,23 RT

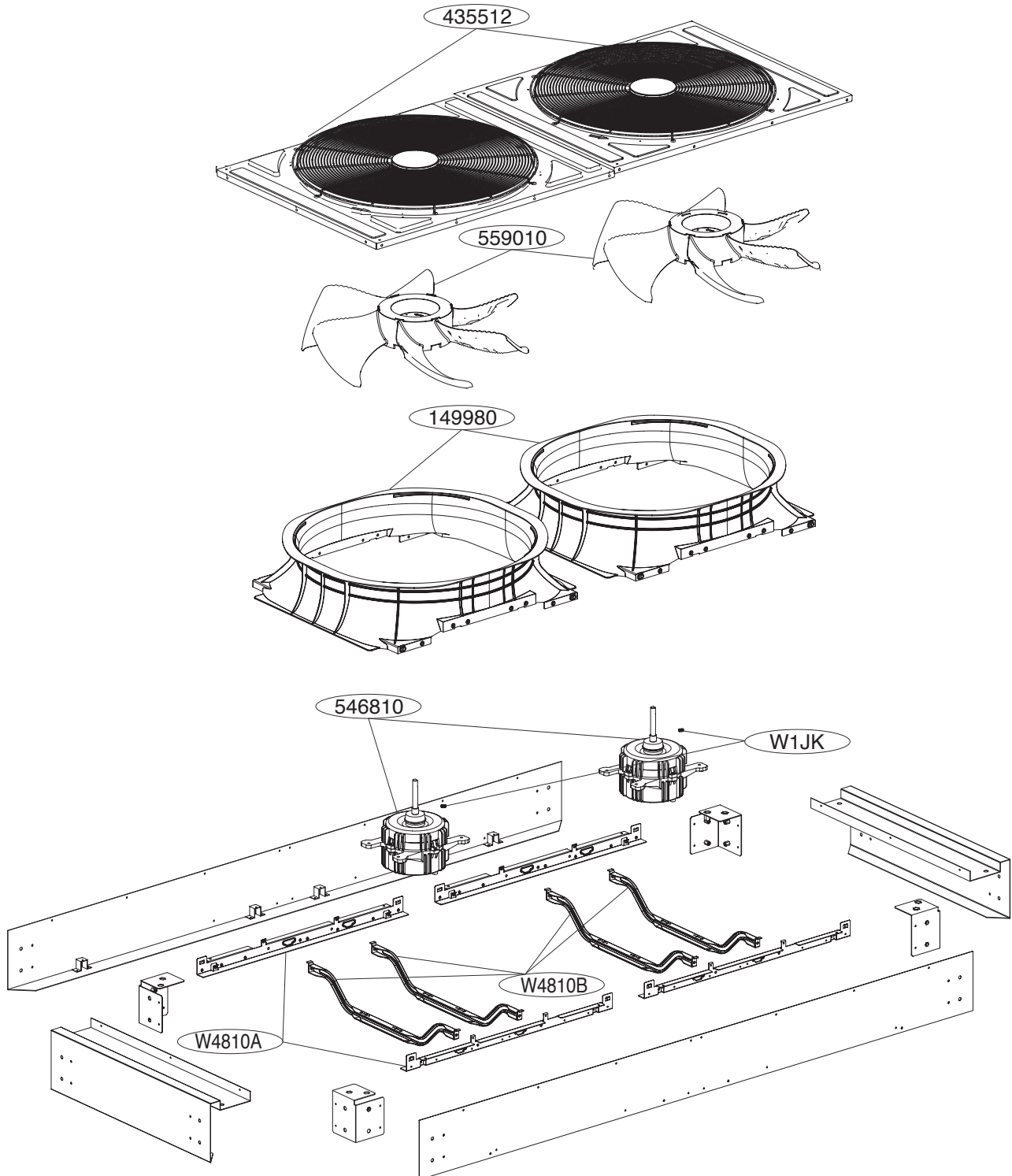

33,40,45, 50,60,67 RT

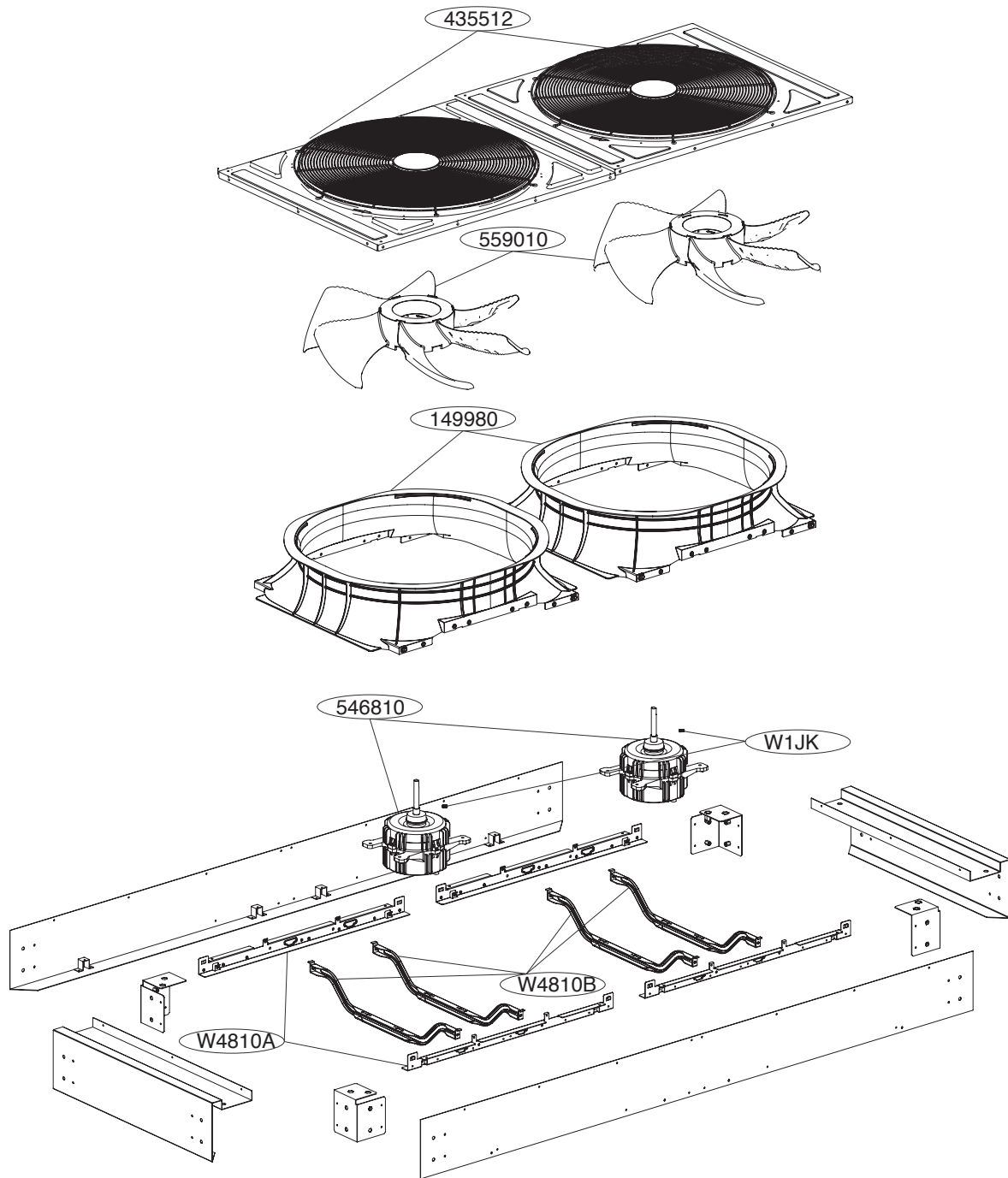

6.2 Condenser Assembly

• ACAH series

1 Unit

• Condenser Assembly Required parts

Condenser Module		
Description	L/No.	Qty
Condenser Assembly,First	554030A	1
Tube Assembly,Distributor	352114A	1
Tube Assembly,Manifold(Outdoor)	552115A	1
Condenser Assembly,First	554030B	1
Tube Assembly,Distributor	352114B	1
Tube Assembly,Manifold(Outdoor)	552115B	1

• Condenser Assembly

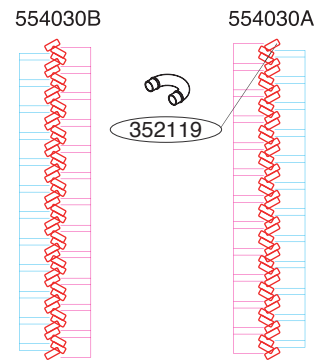

352114B 552115B 552115A 352114A

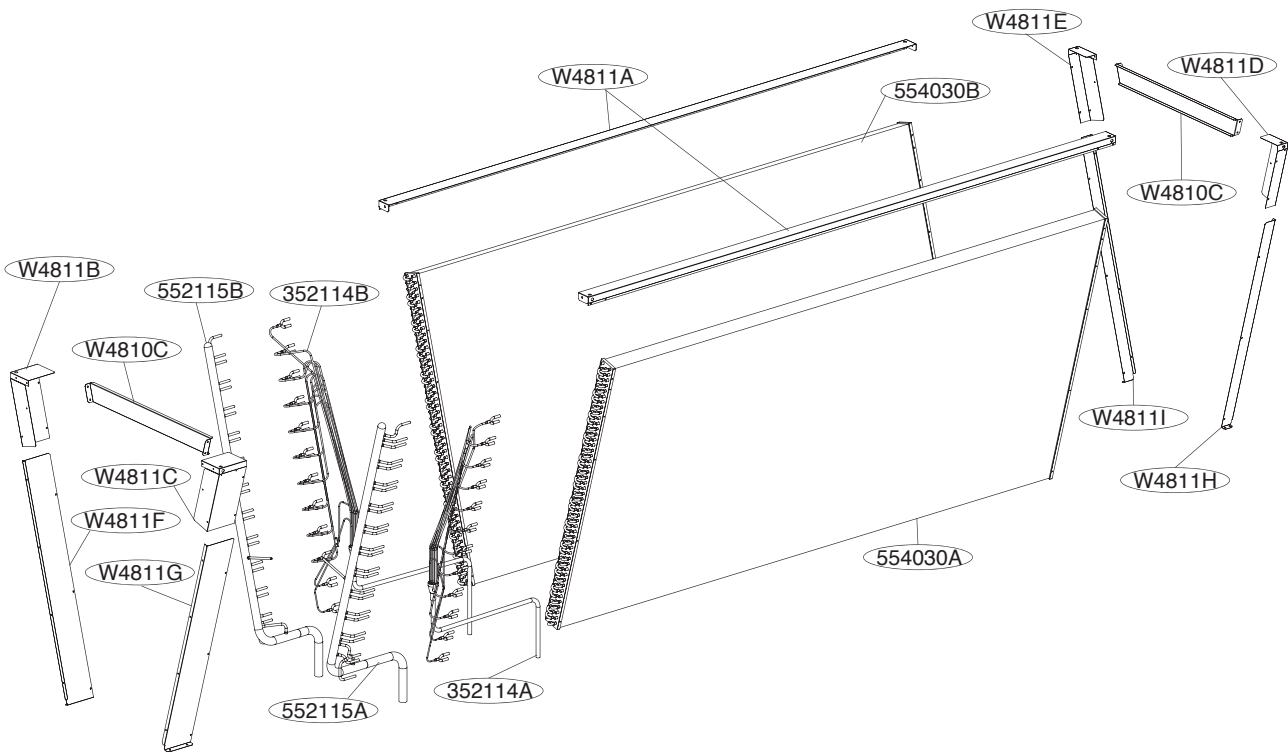

2 Unit, 3 Unit

• Condenser Assembly Required parts

Condenser Module		
Description	L/No.	Qty
Condenser Assembly,First	554030A	1
Tube Assembly,Distributor	352114A	1
Tube Assembly,Manifold(Outdoor)	552115A	1
Condenser Assembly,First	554030B	1
Tube Assembly,Distributor	352114B	1
Tube Assembly,Manifold(Outdoor)	552115B	1

• Condenser Assembly

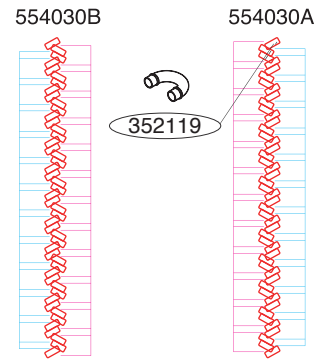

352114B 552115B 552115A 352114A

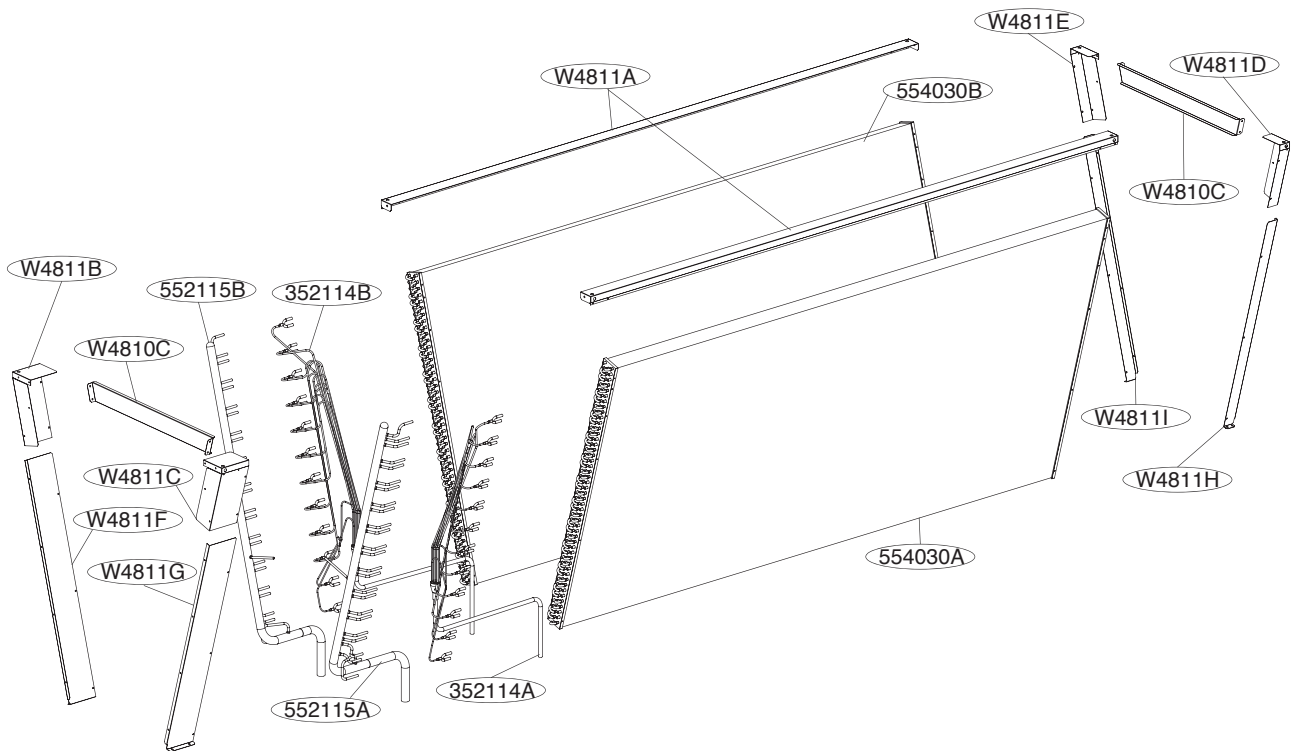

6.3 Structure Parts

- ACAH series

1 Unit

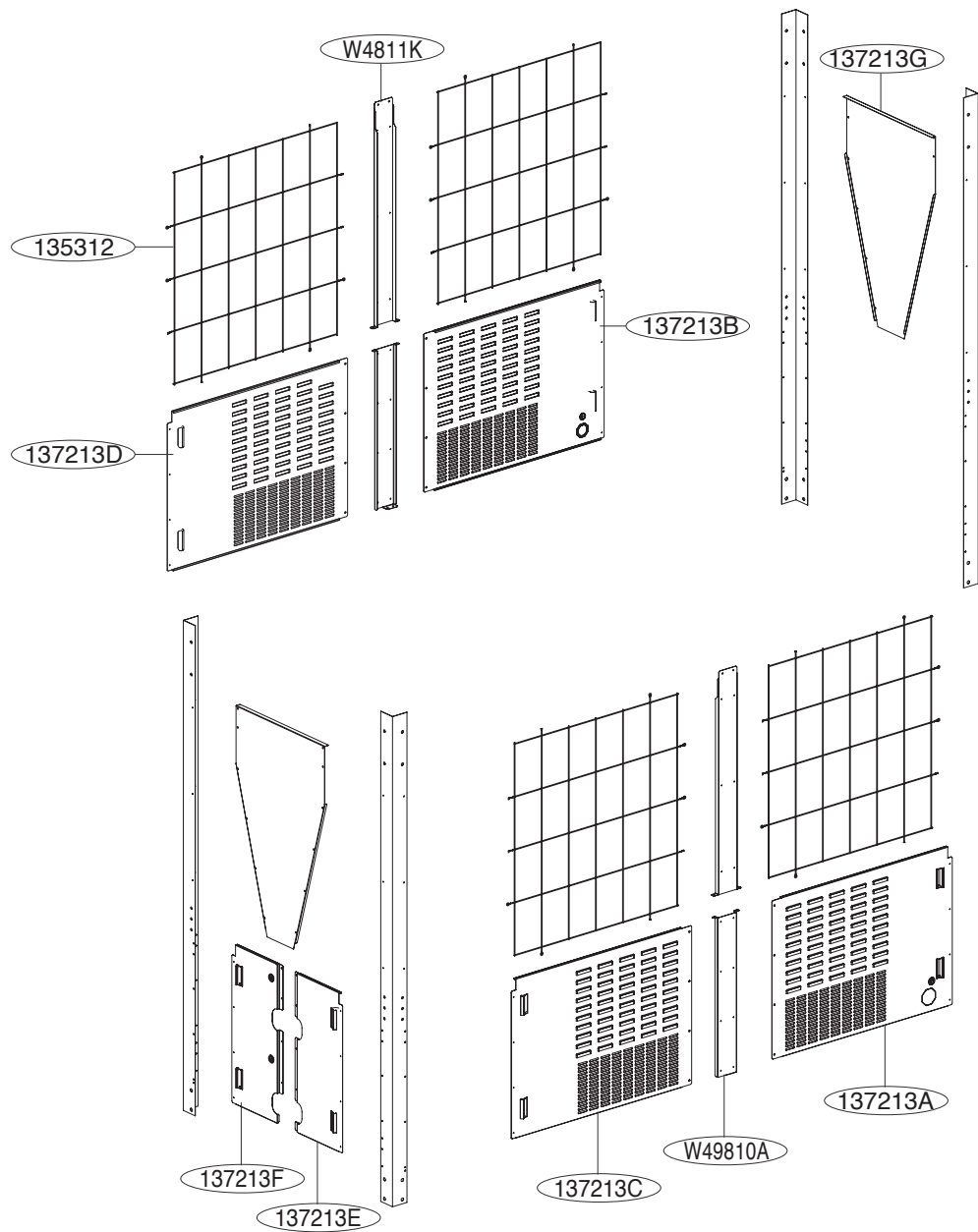

2 Unit

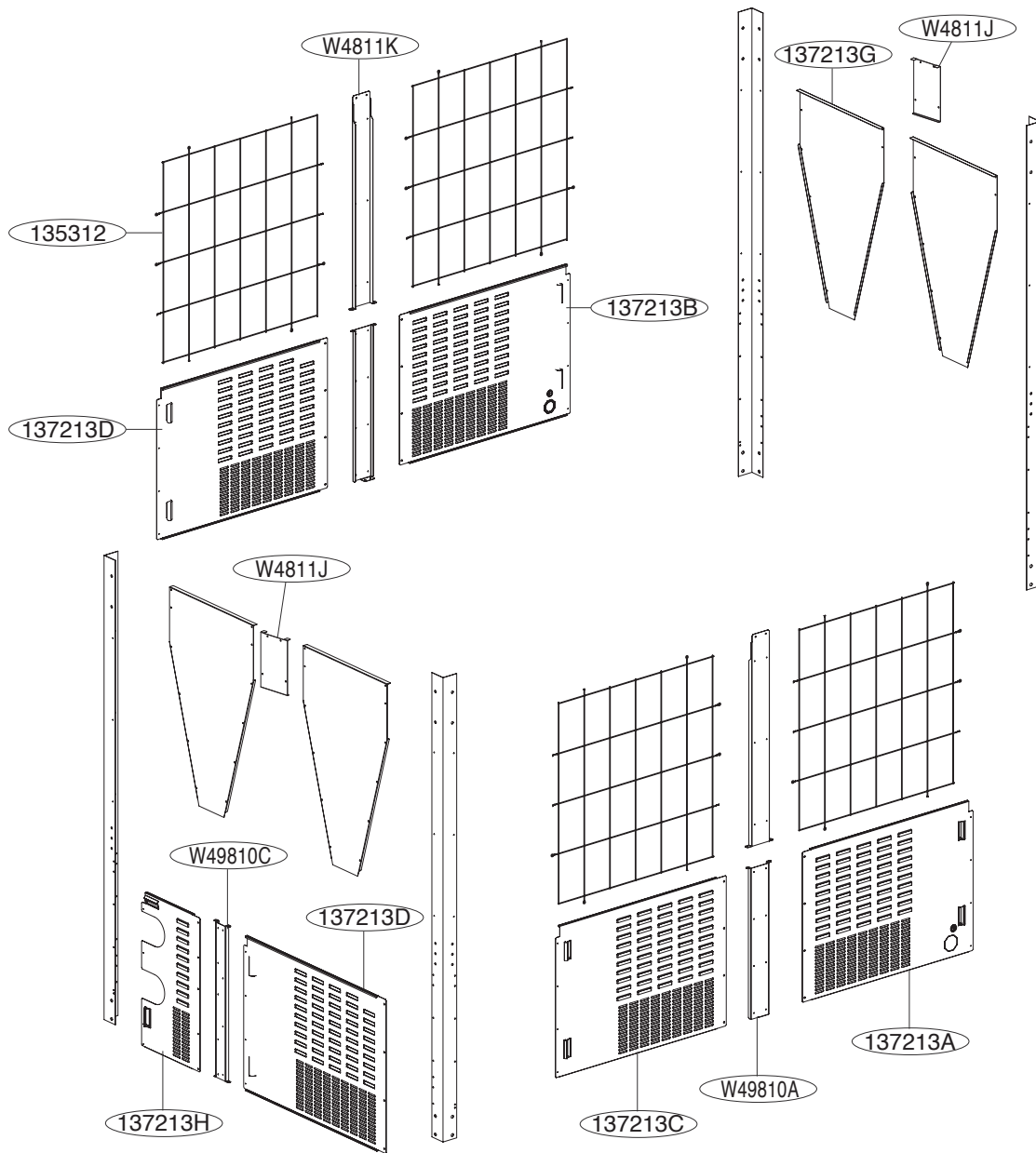

3 Unit

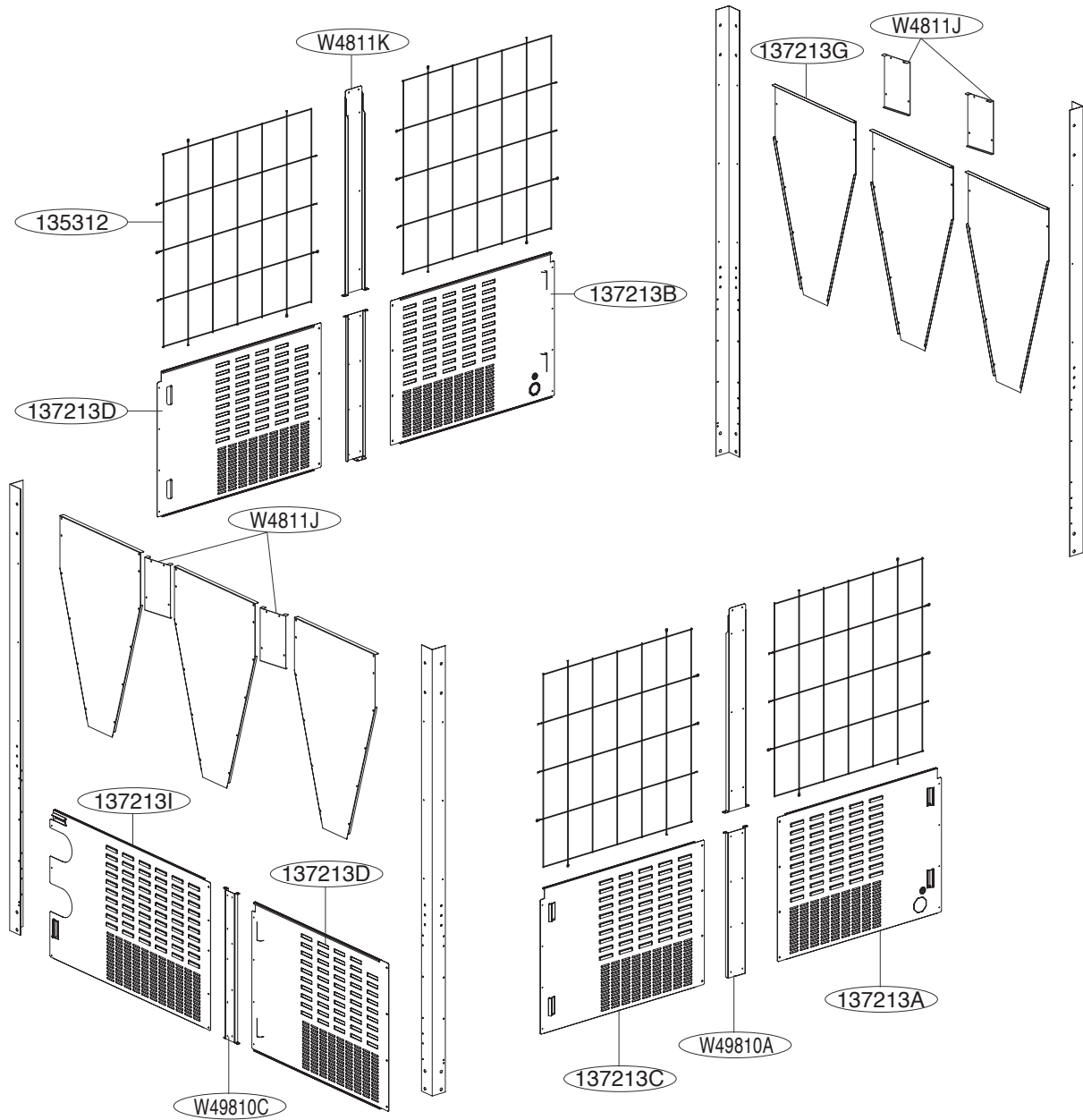

6.4 Cycle Parts

• ACAH series

1 Unit

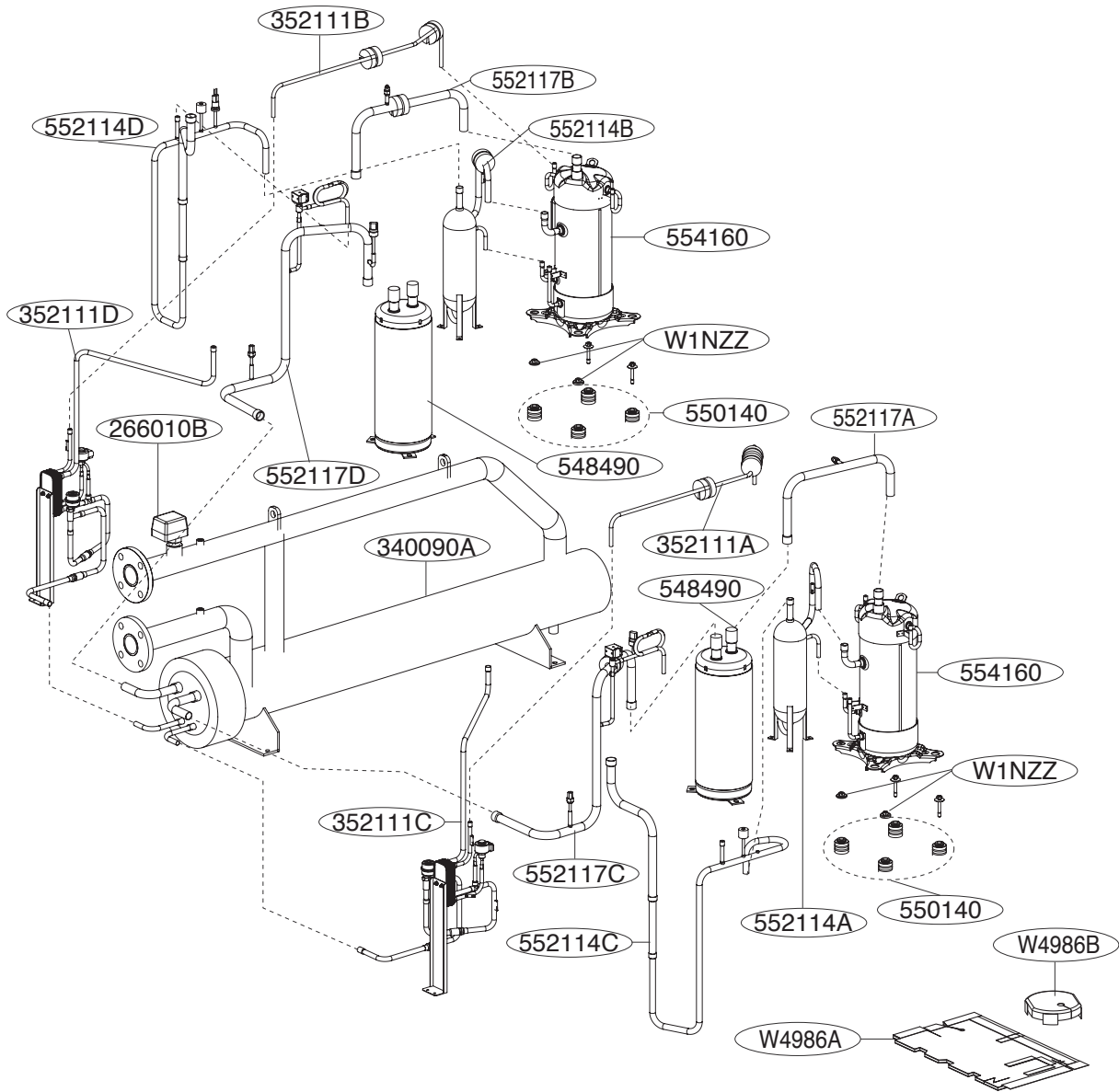

2 Unit

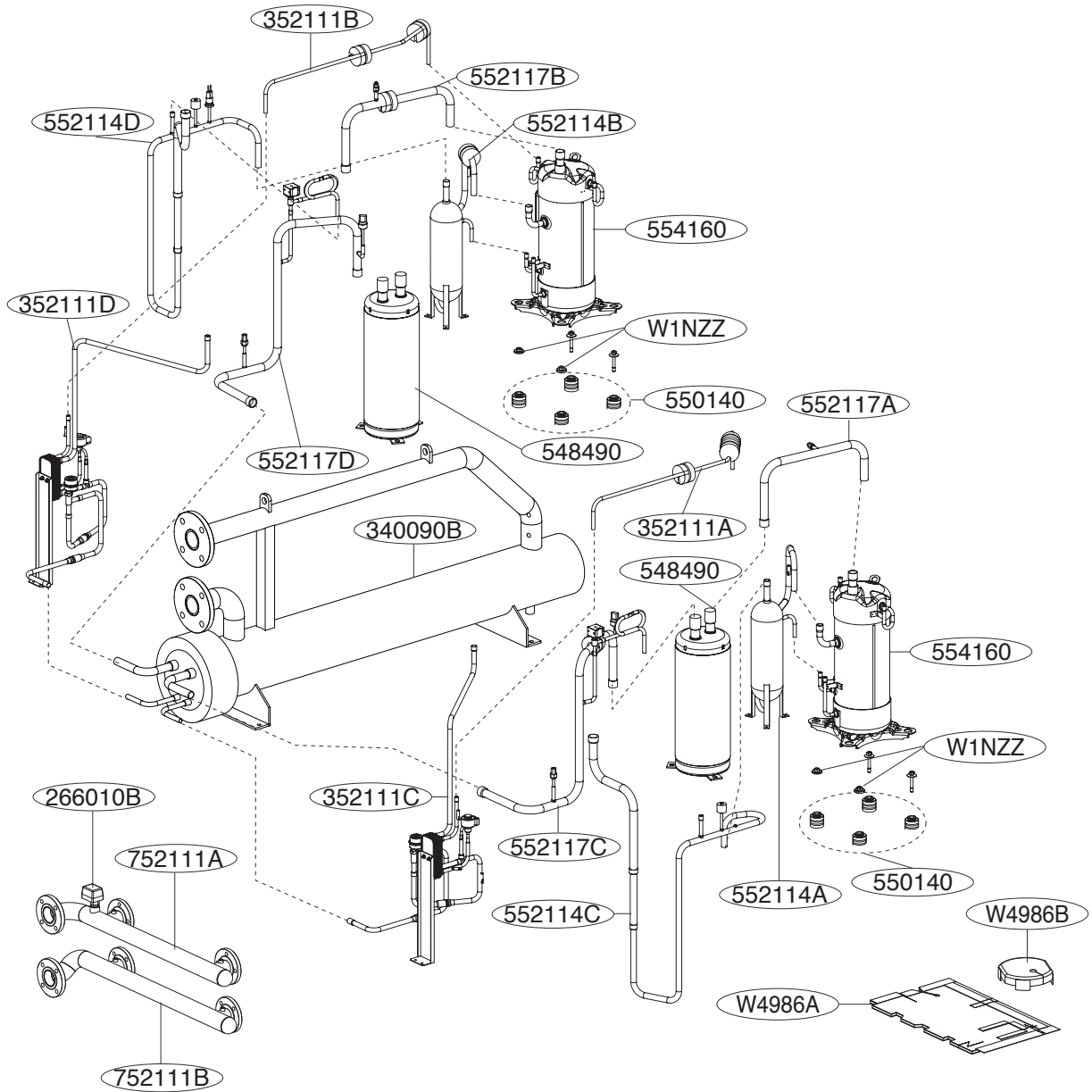

3 Unit

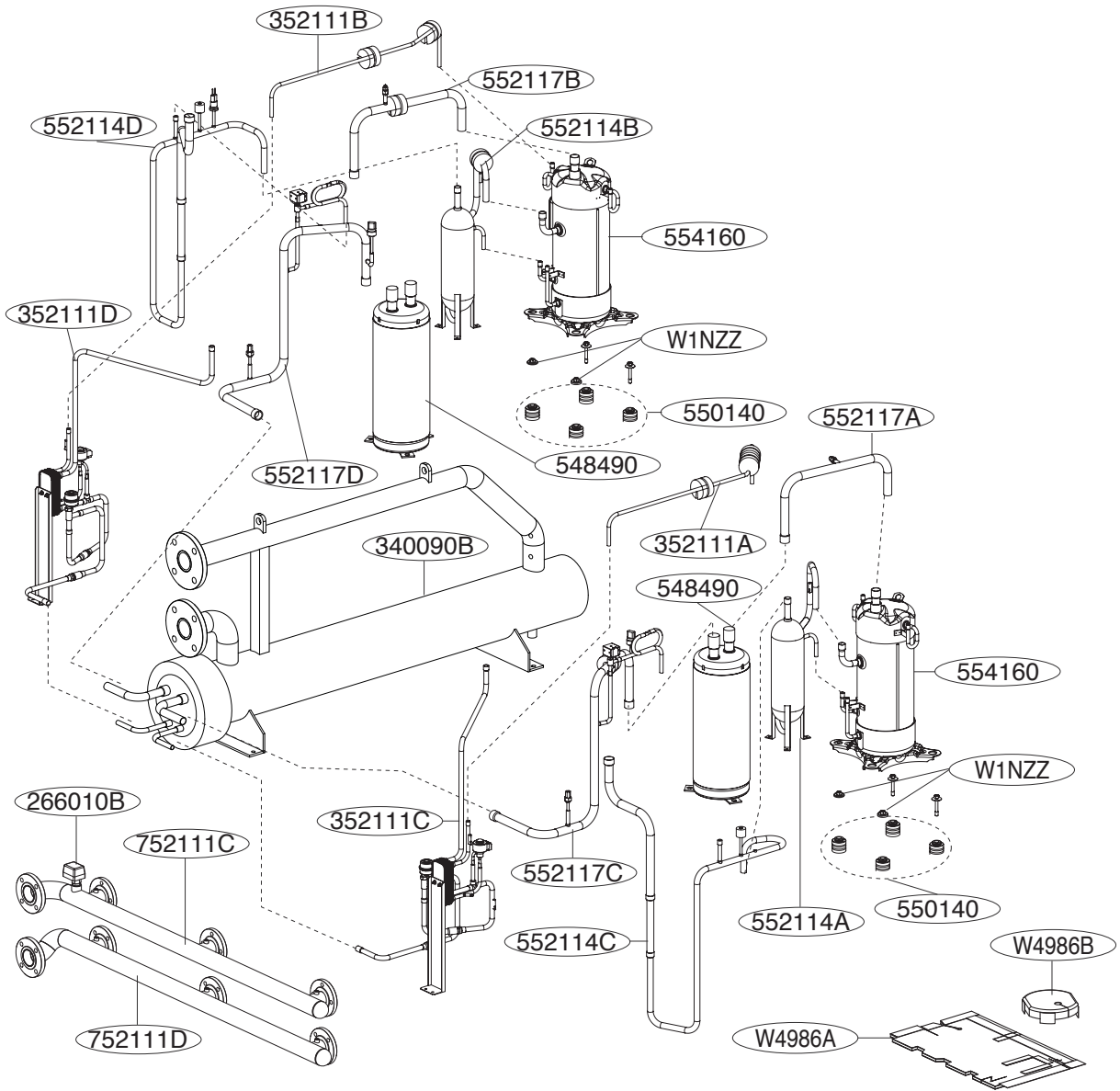

Valve, Sensor parts

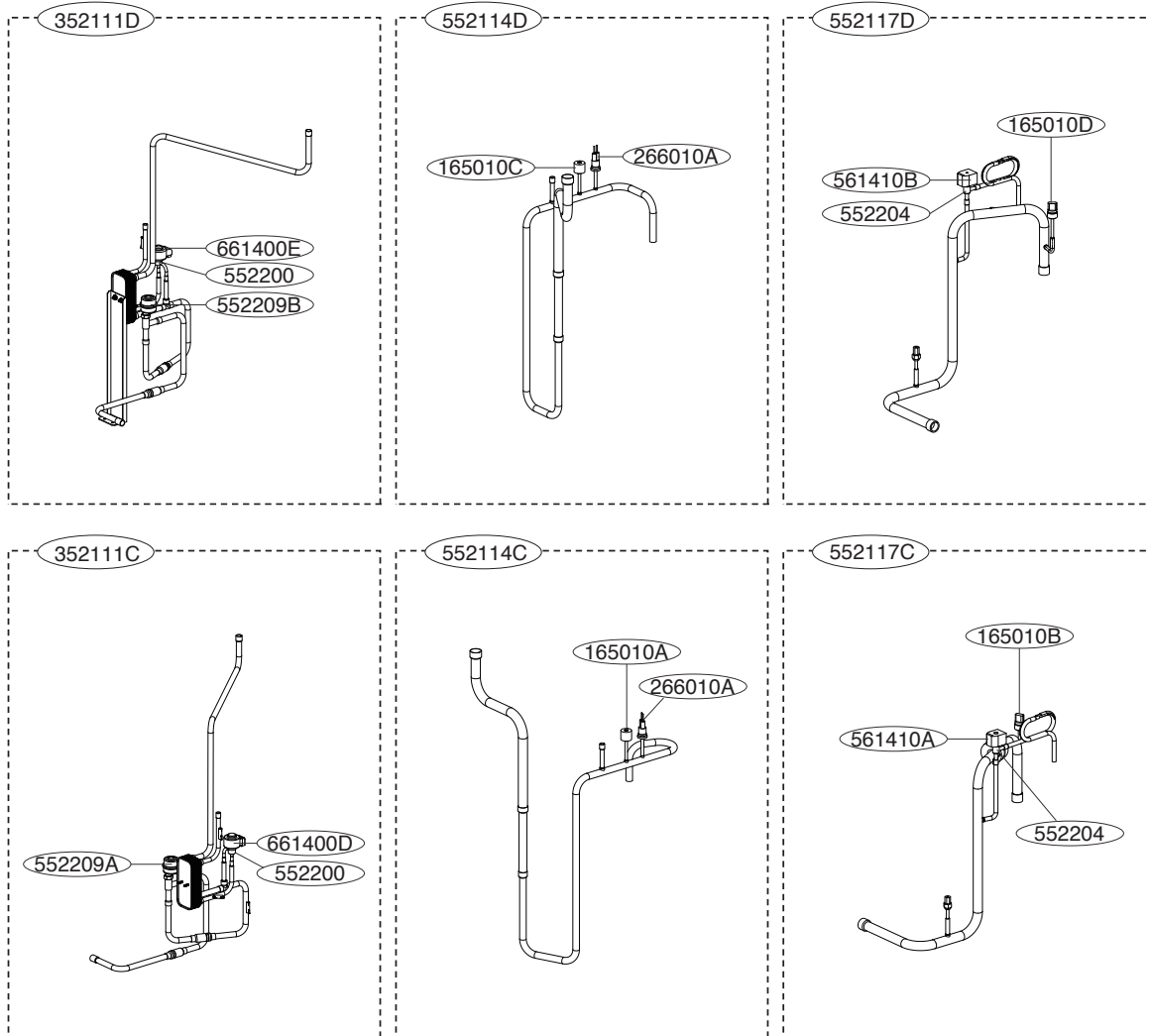

6.5 Base Structure, Control Box Structure

20,23 RT (380 V)

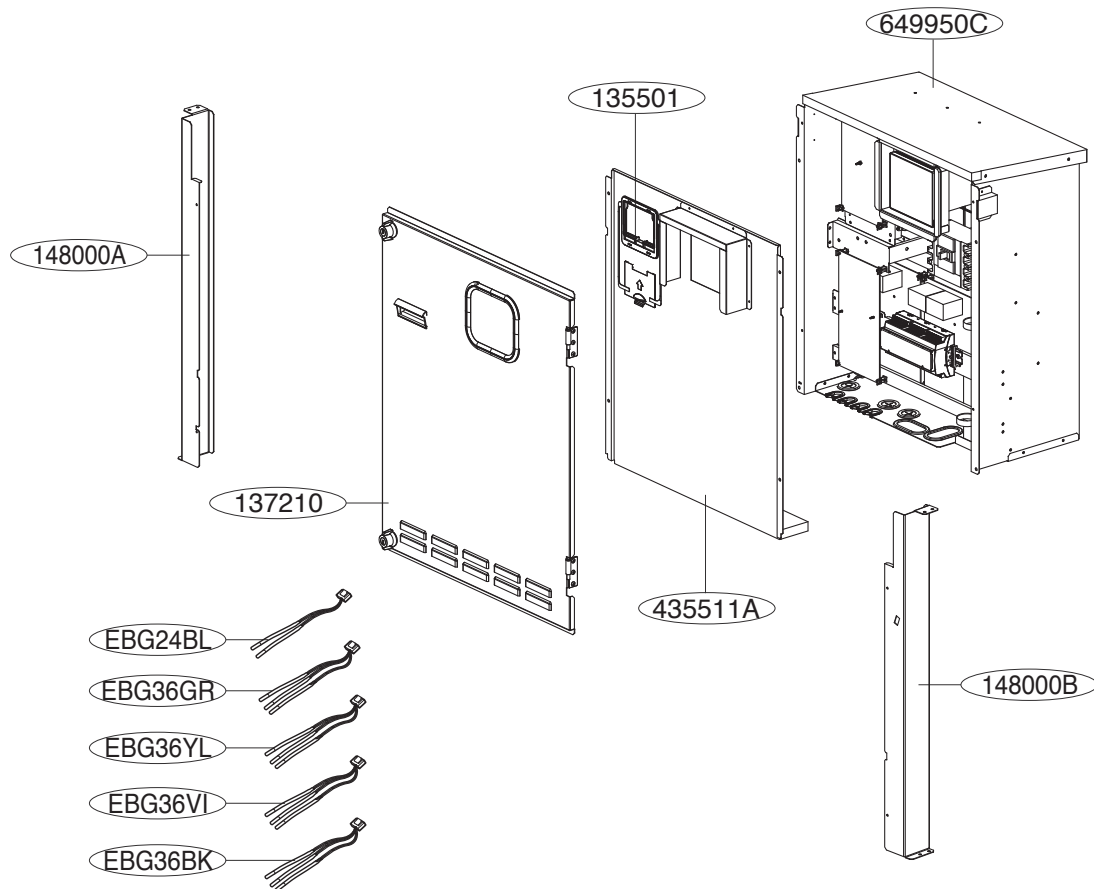

Product name	Location No.	Position	Housing color
Thermistor Assembly,NTC	EBG24BL	Water Pipe Inlet+Outlet	Blue
Thermistor Assembly,NTC	EBG36GR	Comp1 Discharge+Liquid pipe +Suction pipe	Green
Thermistor Assembly,NTC	EBG36YL	Comp2 Discharge+Liquid pipe +Suction pipe	Yellow
Thermistor Assembly,NTC	EBG36VI	Comp1 Hex+SC Out + SC In	Violet
Thermistor Assembly,NTC	EBG36BK	Comp2 Hex+ SC Out + SC In	Black

20,23 RT (460 V)

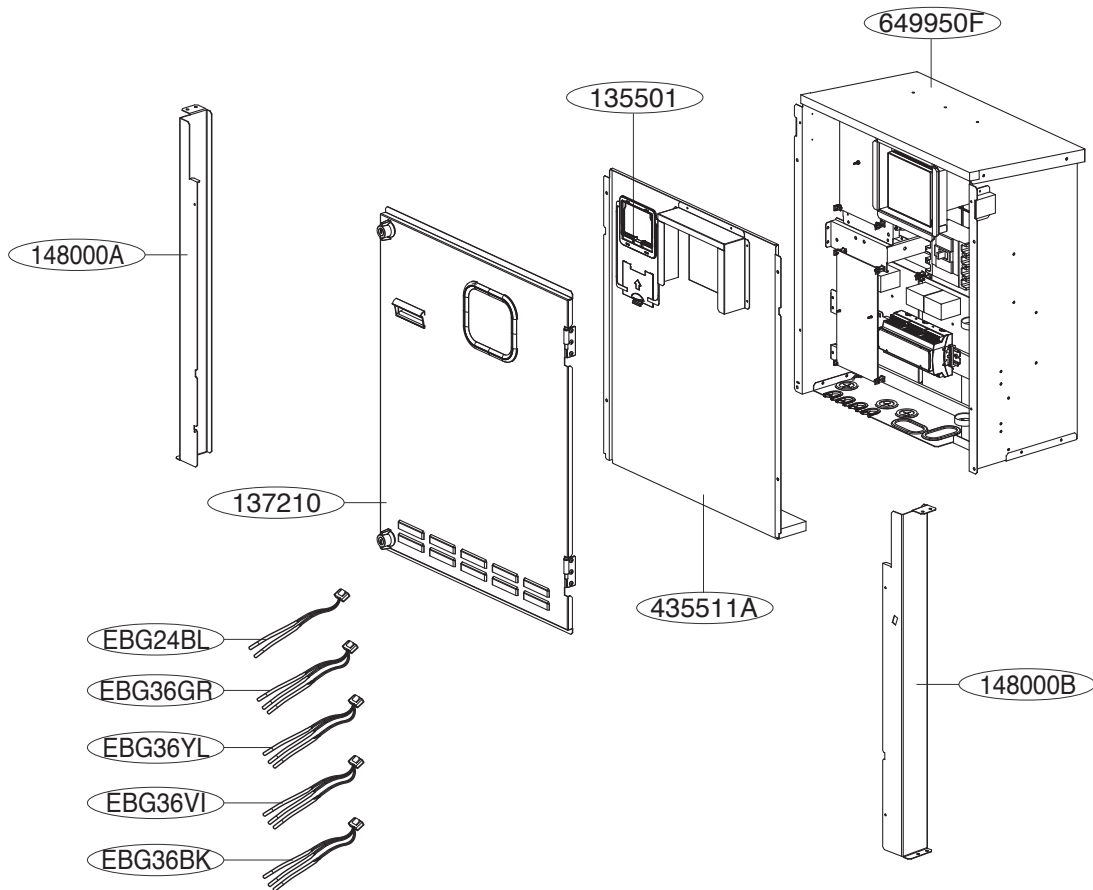

Product name	Location No.	Position	Housing color
Thermistor Assembly,NTC	EBG24BL	Water Pipe Inlet+Outlet	Blue
Thermistor Assembly,NTC	EBG36GR	Comp1 Discharge+Liquid pipe +Suction pipe	Green
Thermistor Assembly,NTC	EBG36YL	Comp2 Discharge+Liquid pipe +Suction pipe	Yellow
Thermistor Assembly,NTC	EBG36VI	Comp1 Hex+SC Out + SC In	Violet
Thermistor Assembly,NTC	EBG36BK	Comp2 Hex+ SC Out + SC In	Black

20 RT (220 V)

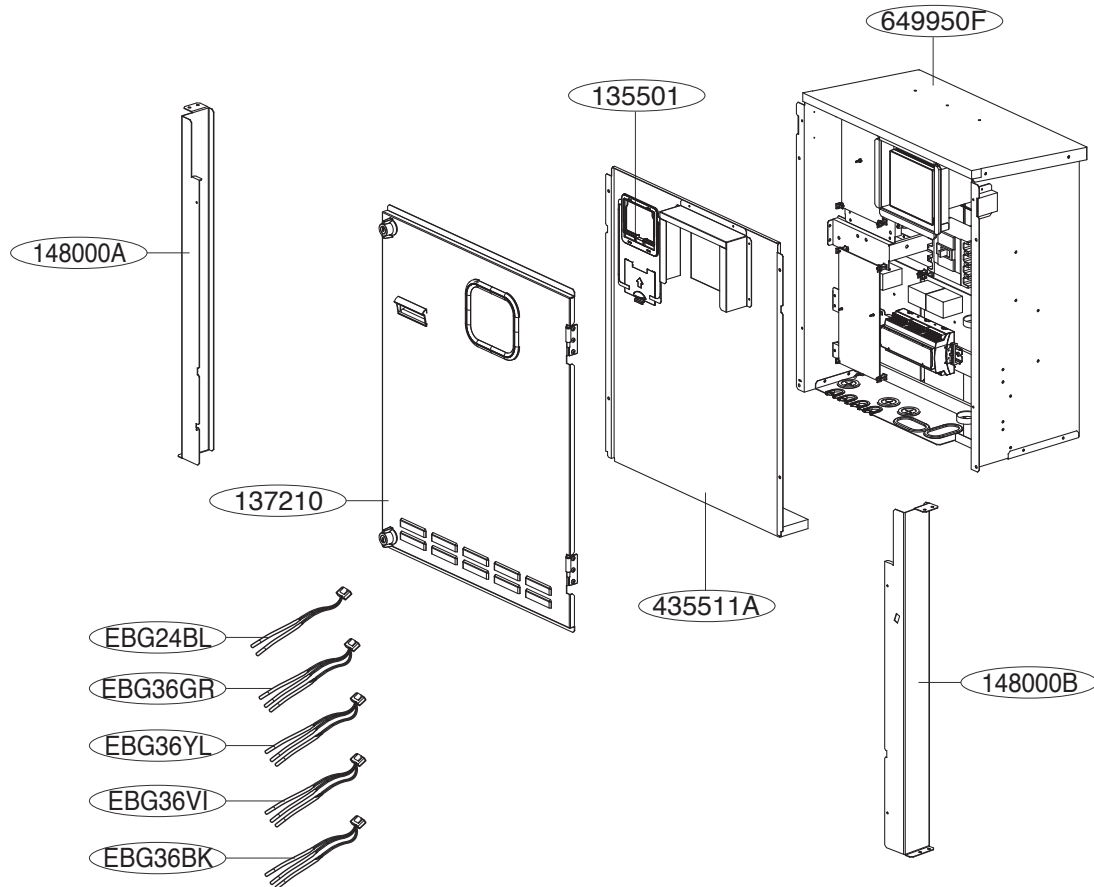

Product name	Location No.	Position	Housing color
Thermistor Assembly,NTC	EBG24BL	Water Pipe Inlet+Outlet	Blue
Thermistor Assembly,NTC	EBG36GR	Comp1 Discharge+Liquid pipe +Suction pipe	Green
Thermistor Assembly,NTC	EBG36YL	Comp2 Discharge+Liquid pipe +Suction pipe	Yellow
Thermistor Assembly,NTC	EBG36VI	Comp1 Hex+SC Out + SC In	Violet
Thermistor Assembly,NTC	EBG36BK	Comp2 Hex+ SC Out + SC In	Black

33,40,45 RT (380 V)

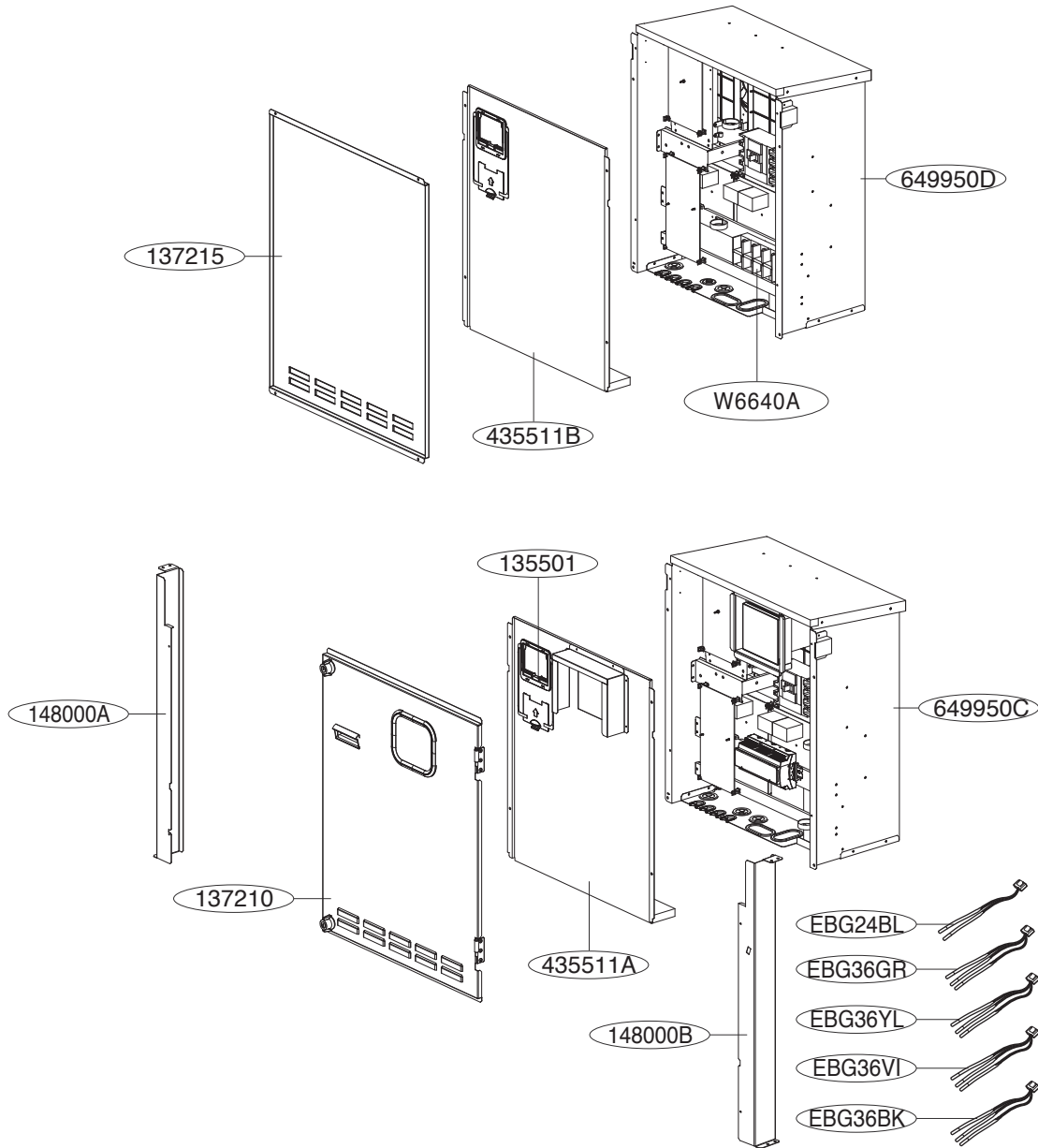

Product name	Location No.	Position	Housing color
Thermistor Assembly,NTC	EBG24BL	Water Pipe Inlet+Outlet	Blue
Thermistor Assembly,NTC	EBG36GR	Comp1 Discharge+Liquid pipe +Suction pipe	Green
Thermistor Assembly,NTC	EBG36YL	Comp2 Discharge+Liquid pipe +Suction pipe	Yellow
Thermistor Assembly,NTC	EBG36VI	Comp1 Hex+SC Out + SC In	Violet
Thermistor Assembly,NTC	EBG36BK	Comp2 Hex+ SC Out + SC In	Black

33,40,45 RT (460 V)

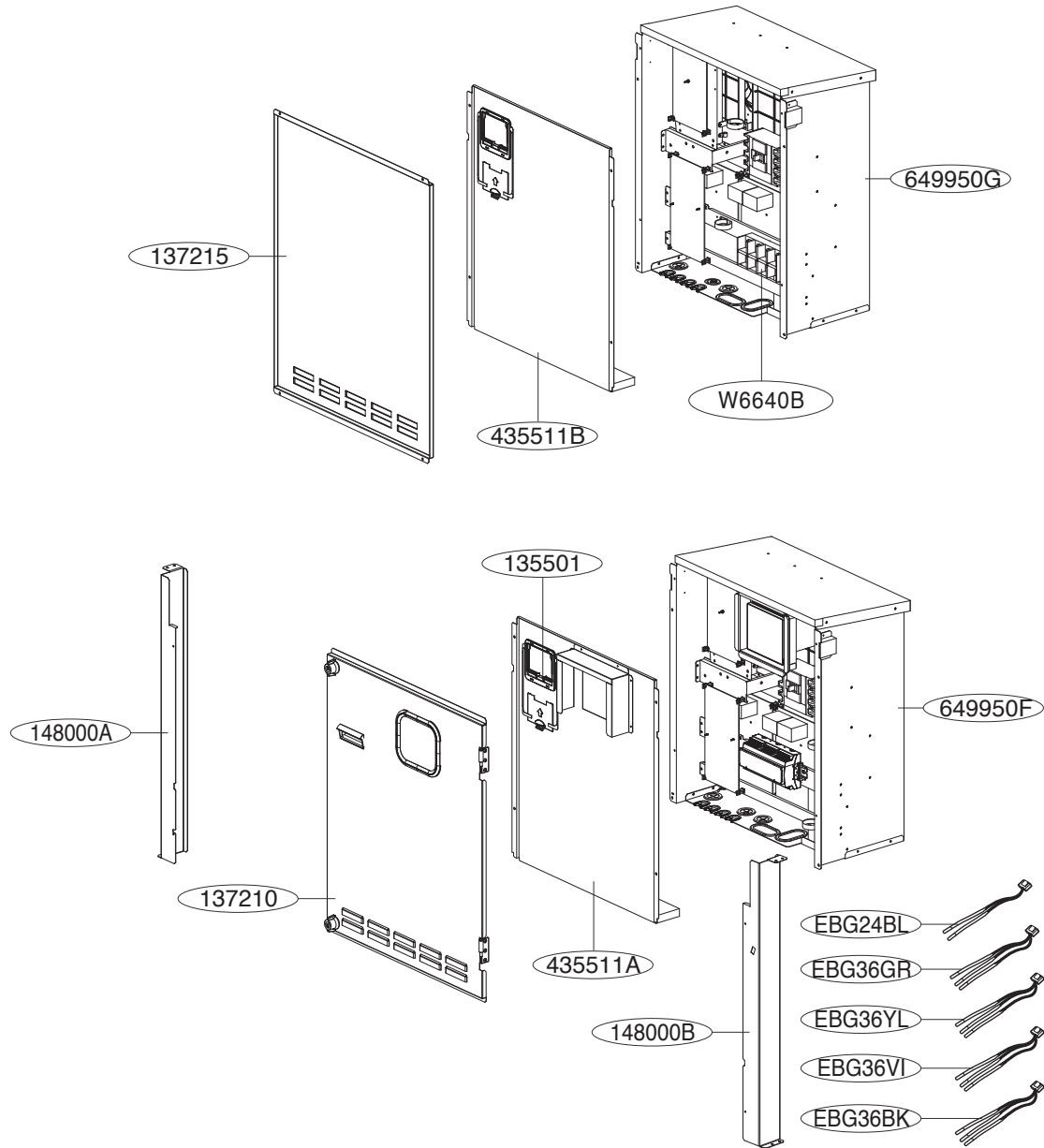

Product name	Location No.	Position	Housing color
Thermistor Assembly,NTC	EBG24BL	Water Pipe Inlet+Outlet	Blue
Thermistor Assembly,NTC	EBG36GR	Comp1 Discharge+Liquid pipe +Suction pipe	Green
Thermistor Assembly,NTC	EBG36YL	Comp2 Discharge+Liquid pipe +Suction pipe	Yellow
Thermistor Assembly,NTC	EBG36VI	Comp1 Hex+SC Out + SC In	Violet
Thermistor Assembly,NTC	EBG36BK	Comp2 Hex+ SC Out + SC In	Black

33,40 RT (220 V)

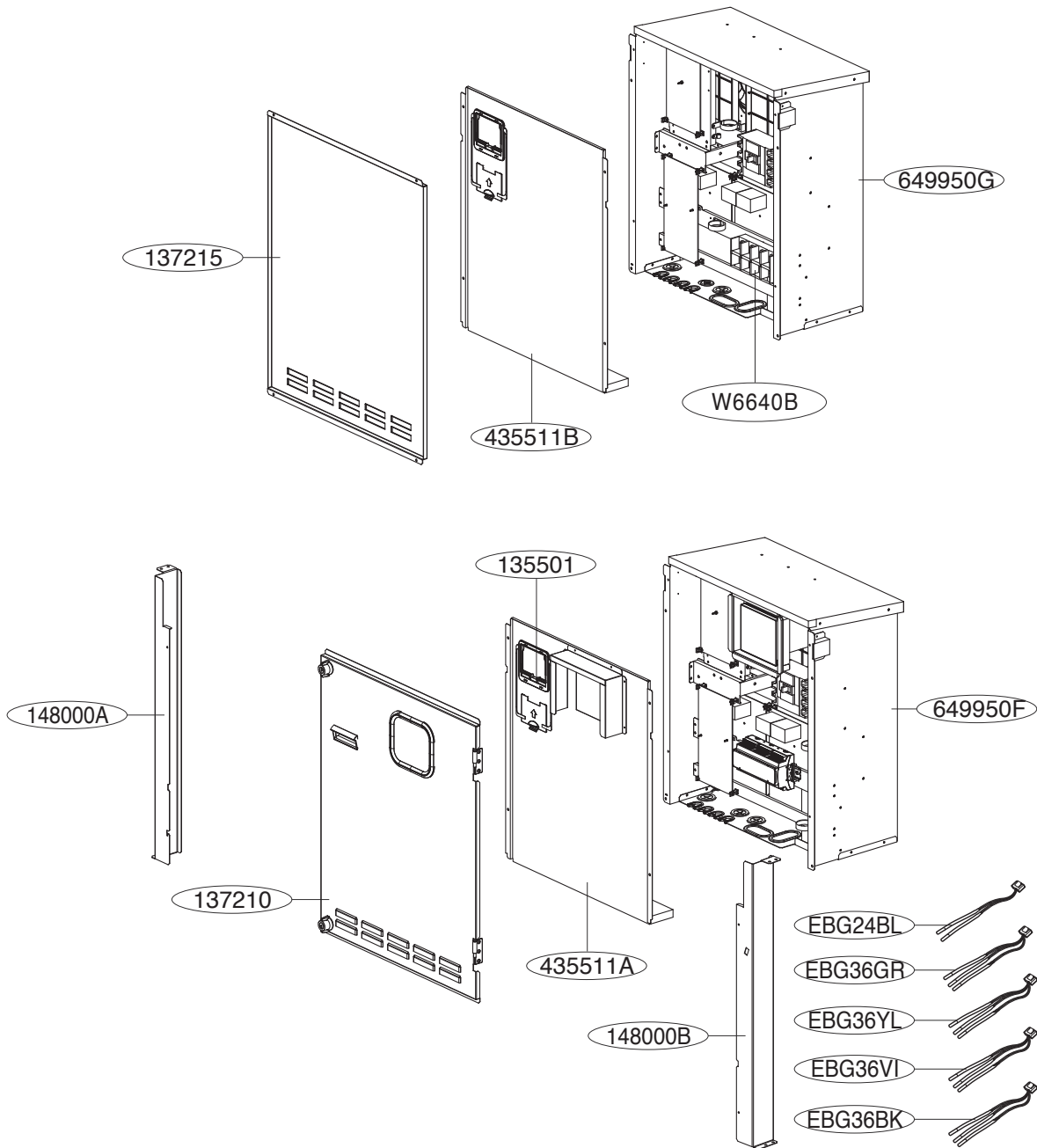

Product name	Location No.	Position	Housing color
Thermistor Assembly,NTC	EBG24BL	Water Pipe Inlet+Outlet	Blue
Thermistor Assembly,NTC	EBG36GR	Comp1 Discharge+Liquid pipe +Suction pipe	Green
Thermistor Assembly,NTC	EBG36YL	Comp2 Discharge+Liquid pipe +Suction pipe	Yellow
Thermistor Assembly,NTC	EBG36VI	Comp1 Hex+SC Out + SC In	Violet
Thermistor Assembly,NTC	EBG36BK	Comp2 Hex+ SC Out + SC In	Black

50,60,67 RT (380 V)

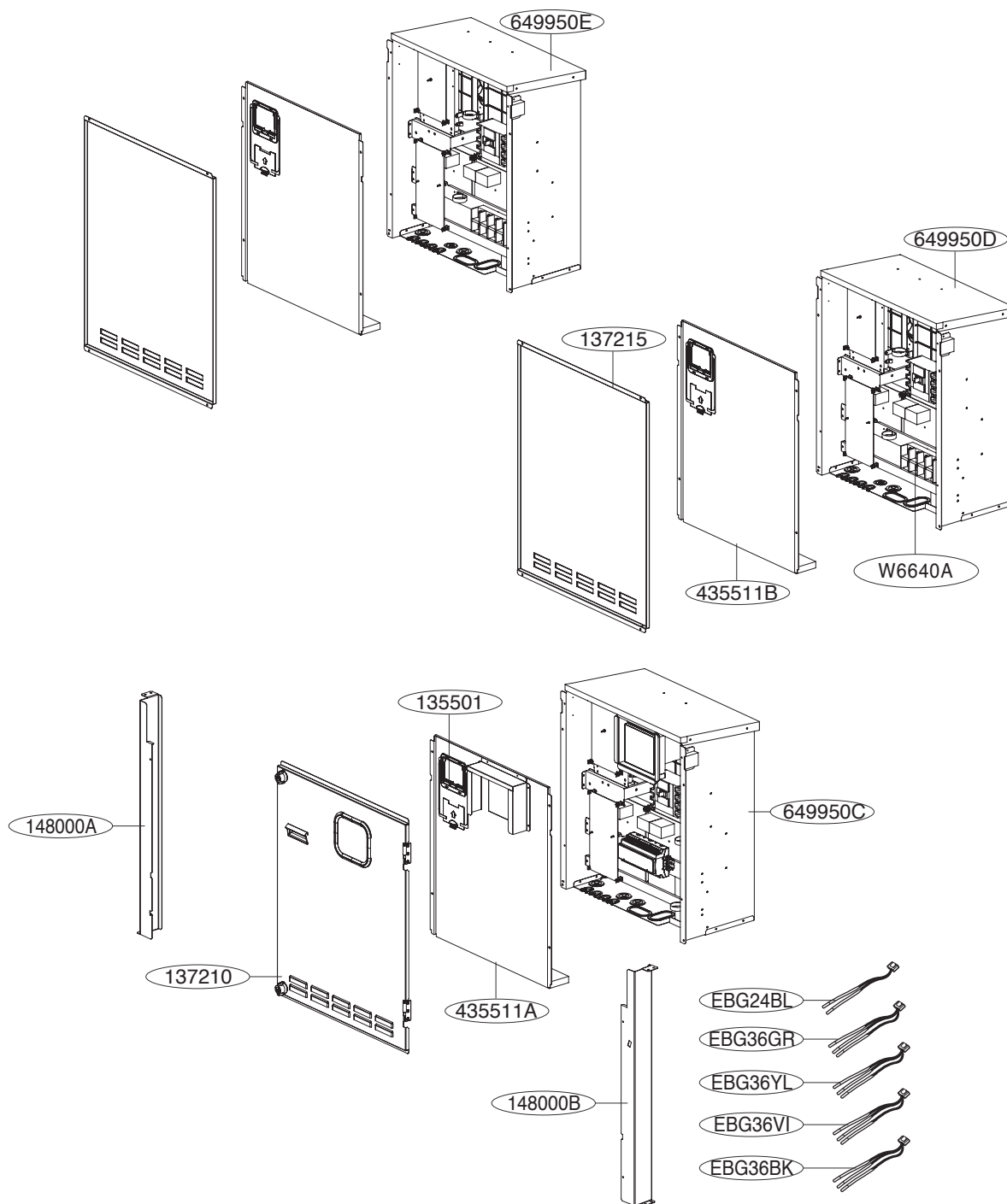

Product name	Location No.	Position	Housing color
Thermistor Assembly,NTC	EBG24BL	Water Pipe Inlet+Outlet	Blue
Thermistor Assembly,NTC	EBG36GR	Comp1 Discharge+Liquid pipe +Suction pipe	Green
Thermistor Assembly,NTC	EBG36YL	Comp2 Discharge+Liquid pipe +Suction pipe	Yellow
Thermistor Assembly,NTC	EBG36VI	Comp1 Hex+SC Out + SC In	Violet
Thermistor Assembly,NTC	EBG36BK	Comp2 Hex+ SC Out + SC In	Black

50,60,67 RT (460 V)

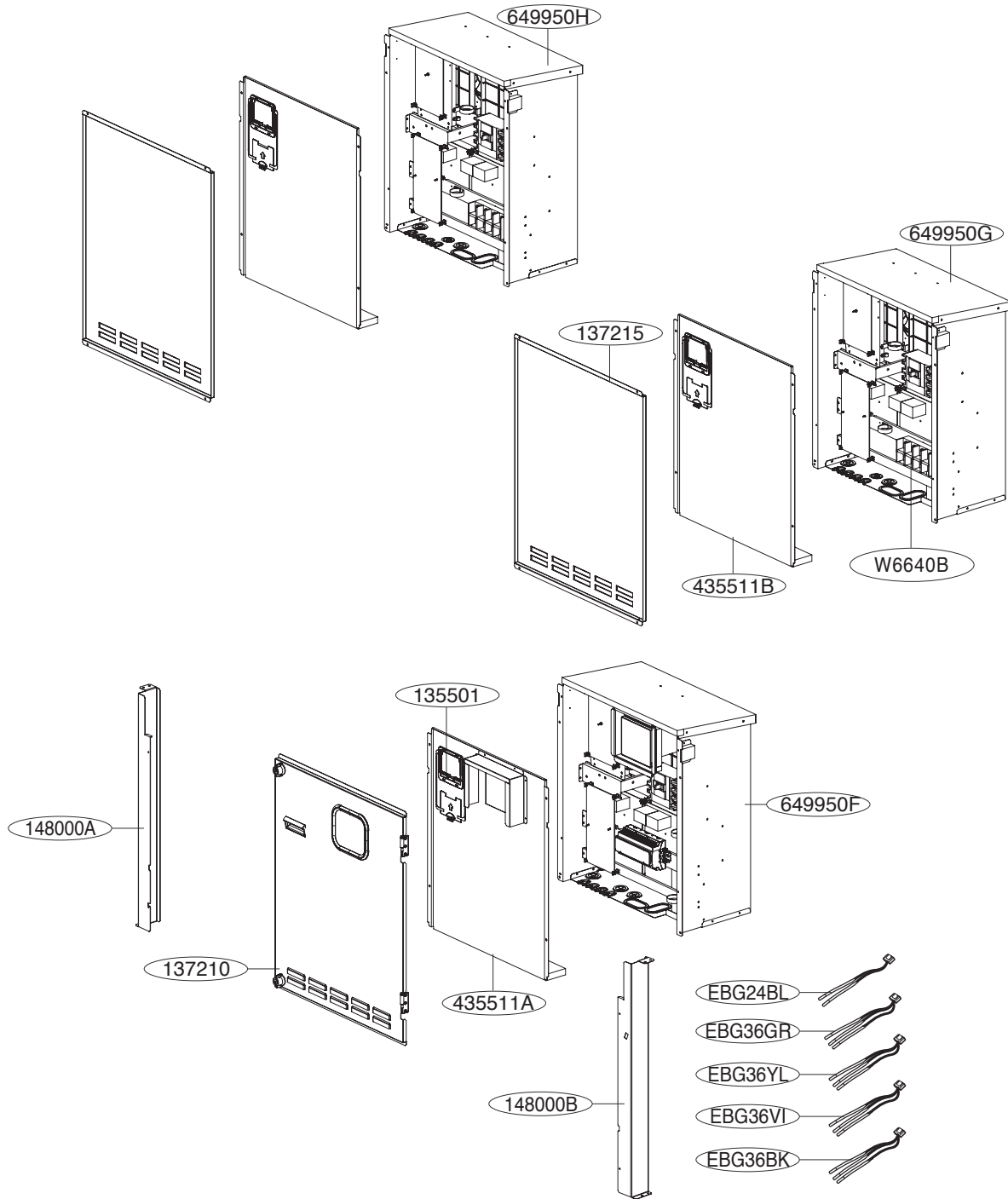

Product name	Location No.	Position	Housing color
Thermistor Assembly,NTC	EBG24BL	Water Pipe Inlet+Outlet	Blue
Thermistor Assembly,NTC	EBG36GR	Comp1 Discharge+Liquid pipe +Suction pipe	Green
Thermistor Assembly,NTC	EBG36YL	Comp2 Discharge+Liquid pipe +Suction pipe	Yellow
Thermistor Assembly,NTC	EBG36VI	Comp1 Hex+SC Out + SC In	Violet
Thermistor Assembly,NTC	EBG36BK	Comp2 Hex+ SC Out + SC In	Black

50,60 RT (220 V)

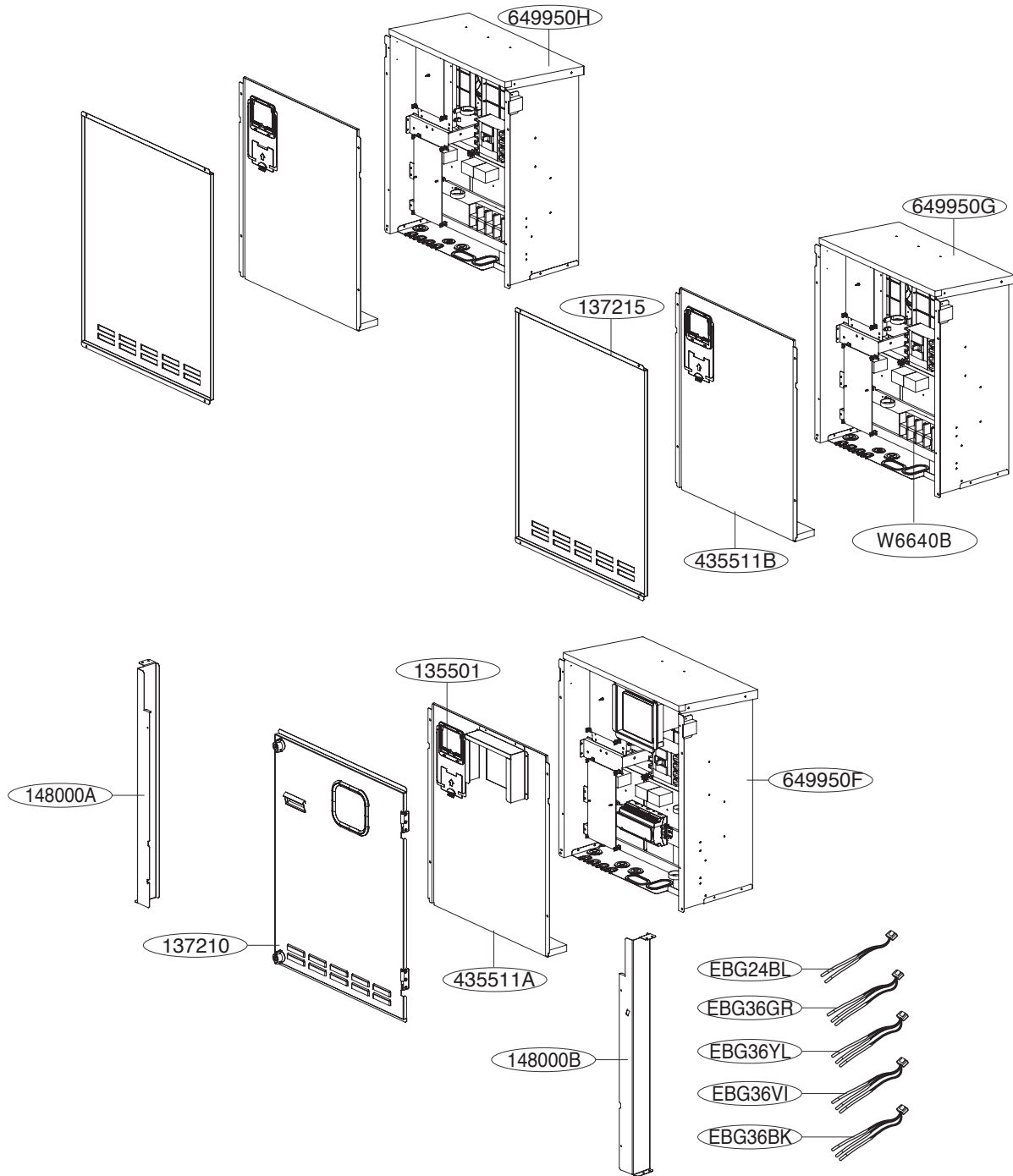

Product name	Location No.	Position	Housing color
Thermistor Assembly,NTC	EBG24BL	Water Pipe Inlet+Outlet	Blue
Thermistor Assembly,NTC	EBG36GR	Comp1 Discharge+Liquid pipe +Suction pipe	Green
Thermistor Assembly,NTC	EBG36YL	Comp2 Discharge+Liquid pipe +Suction pipe	Yellow
Thermistor Assembly,NTC	EBG36VI	Comp1 Hex+SC Out + SC In	Violet
Thermistor Assembly,NTC	EBG36BK	Comp2 Hex+ SC Out + SC In	Black

6.6 Control Box Parts

380 V

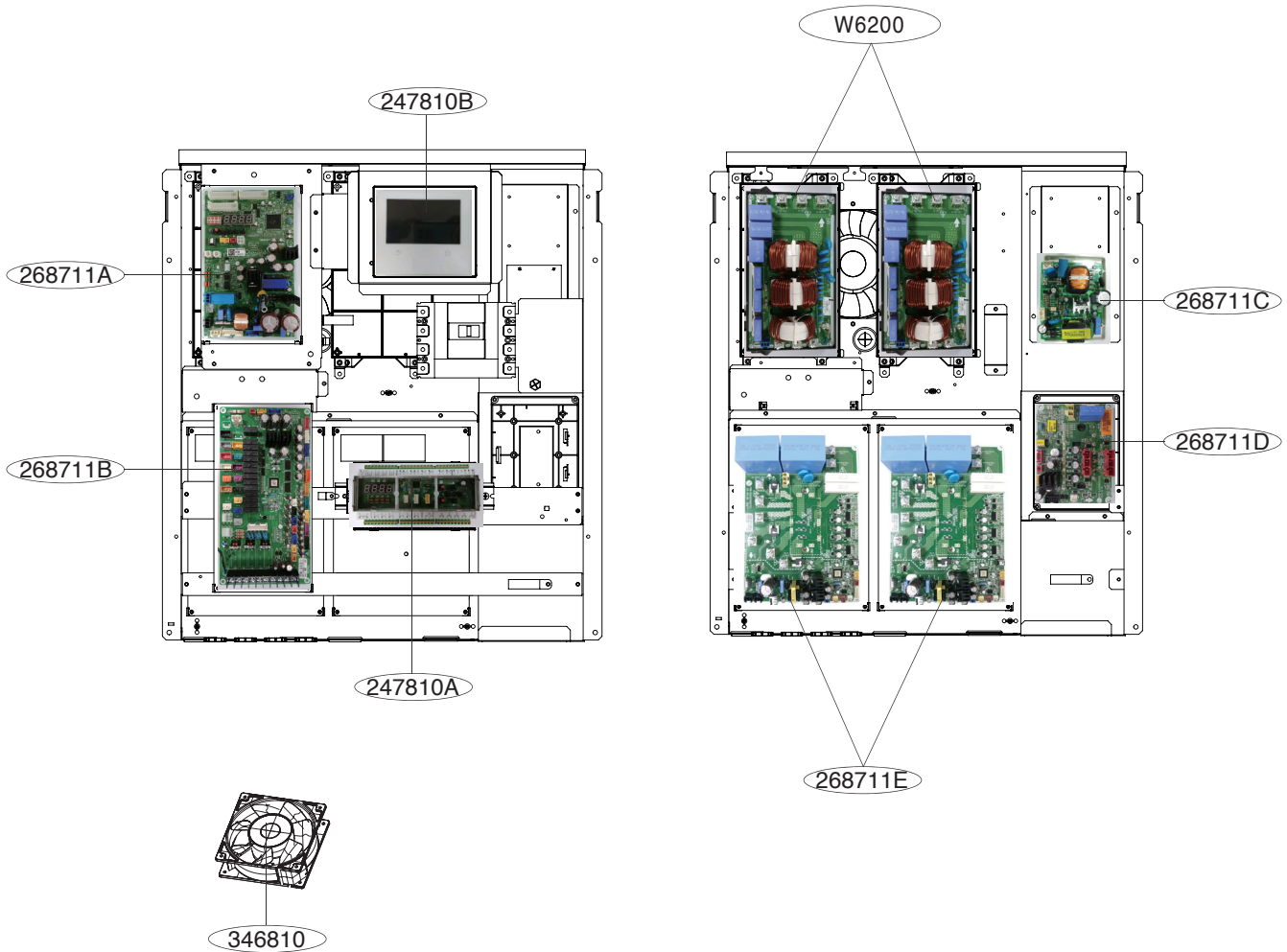

Product name	Location No.	Position	Remarks
PCB	268711A	Main PCB	
PCB	268711B	External PCB	
PCB	268711C	Adapter PCB	
PCB	268711D	Fan PCB	
PCB	268711E	Inverter PCB	

460 V

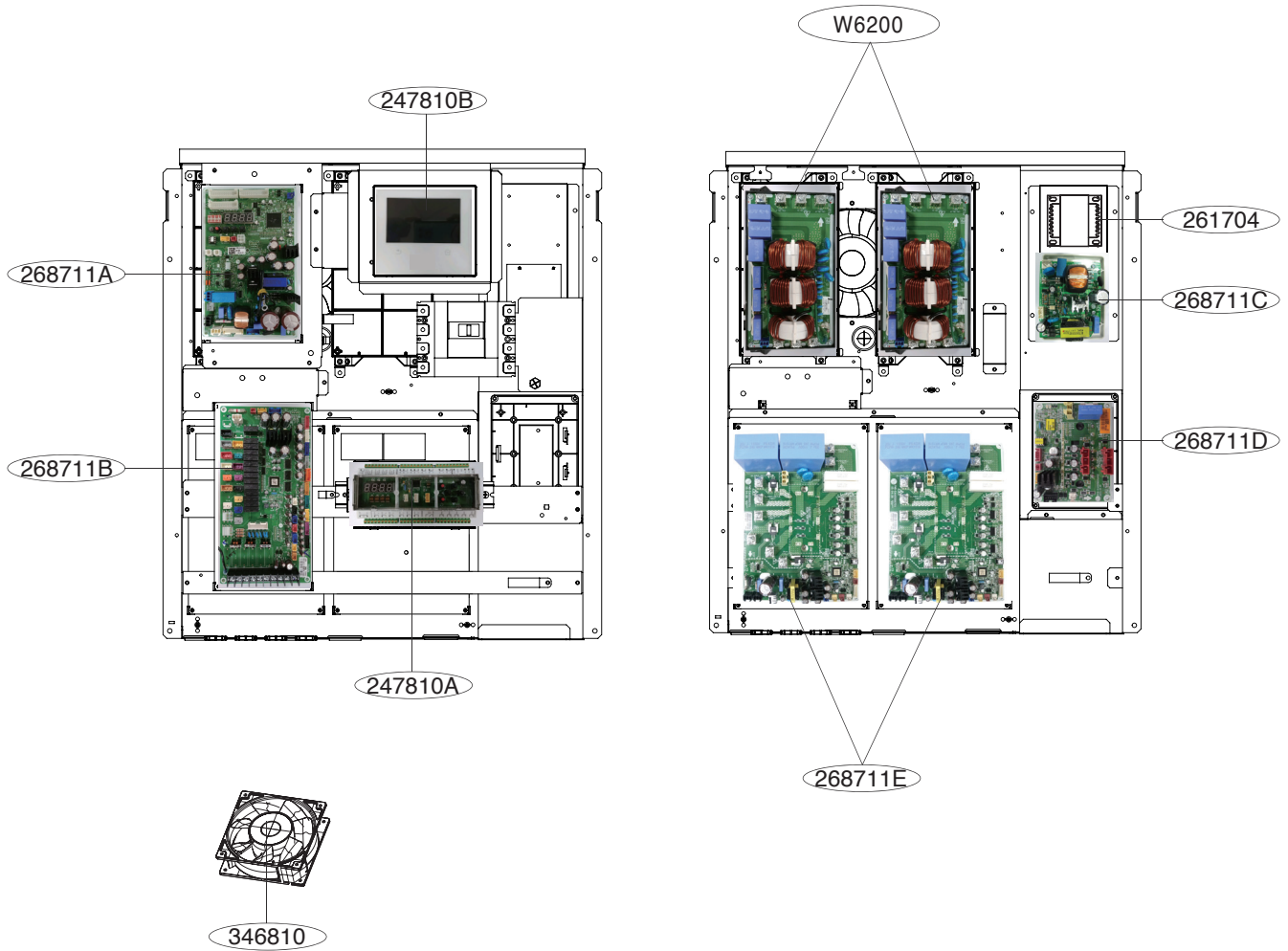

Product name	Location No.	Position	Remarks
PCB	268711A	Main PCB	
PCB	268711B	External PCB	
PCB	268711C	Adapter PCB	
PCB	268711D	Fan PCB	
PCB	268711E	Inverter PCB	

220 V

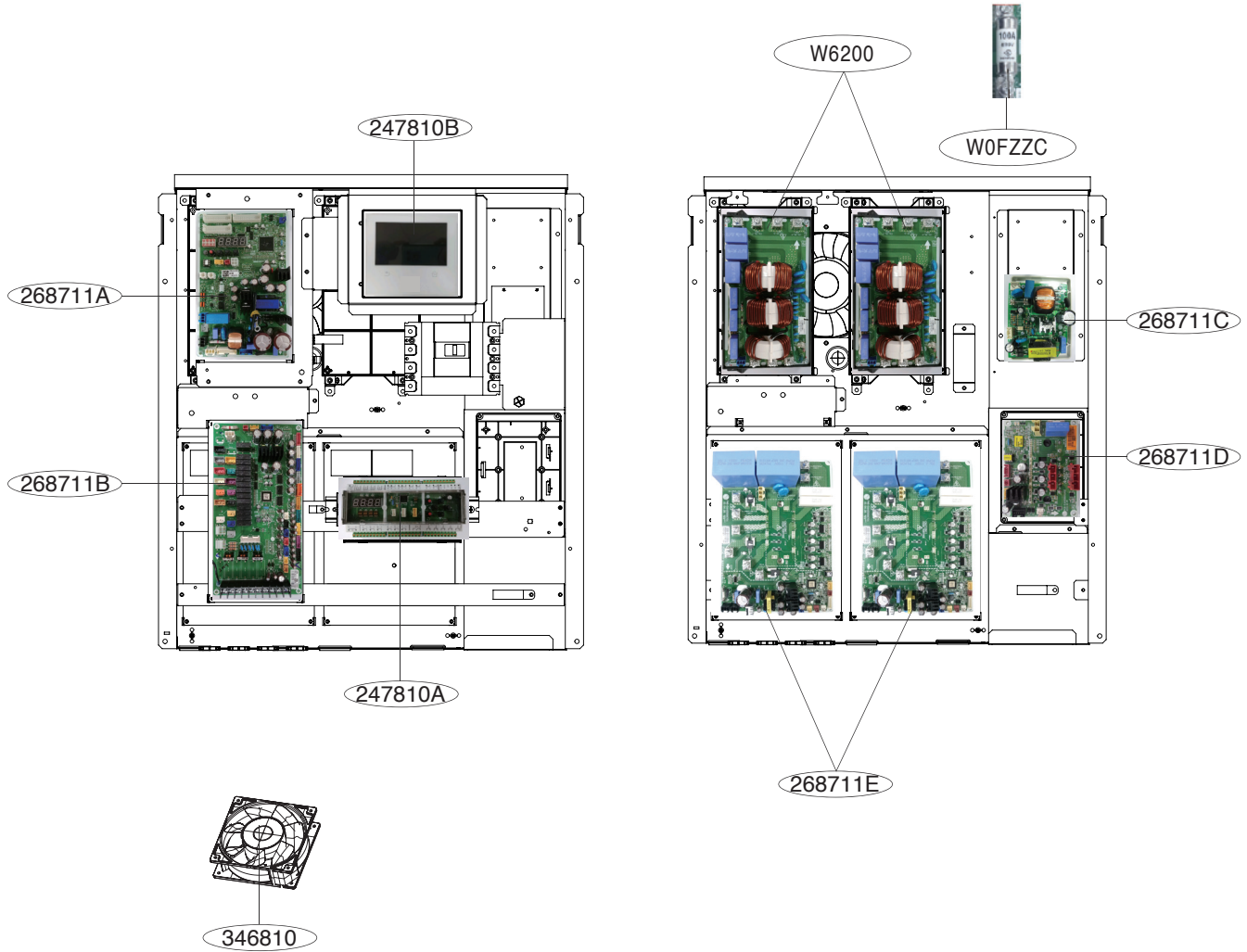

Product name	Location No.	Position	Remarks
PCB	268711A	Main PCB	
PCB	268711B	External PCB	
PCB	268711C	Adapter PCB	
PCB	268711D	Fan PCB	
PCB	268711E	Inverter PCB	

7. The phenomena from main component failure

The phenomena from main component failure

Component	Phenomenon	Cause	Check method and Trouble shooting
Compressor	Not operating	Motor insulation broken	Check resistance between terminals and chassis
		Strainer clogged	Change strainer
		Oil leakage	Check oil amount after opening oil port
	Stop during running	Motor insulation failure	Check resistance between terminals and chassis
	Abnormal noise during running	R-S-T misconnection	Check compressor R-S-T connection
Outdoor fan	High pressure error in cooling mode operation	Motor failure, bad ventilation around outdoor heat exchanger	Check the fan operation to confirm proper motor functioning. Switch OFF the outdoor unit and remove obstacles, if any, around the HEX. Check connector
Outdoor EEV	No operation sound after switching ON the power supply	Coil failure	Service necessary
	Low pressure error or discharge temperature error	EEV closed	Please replace necessary

When system fault occurs, the error code is displayed on the indoor unit display or remote control display.

EEV

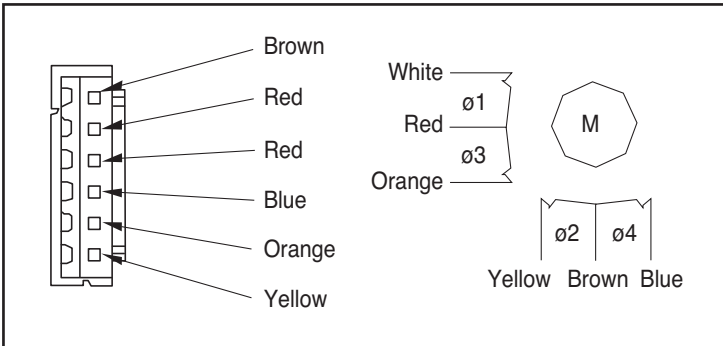

• Pulse signal output value and valve operation

Output(ø) No.	Output state			
	1	2	3	4
ø1	ON	ON	OFF	OFF
ø2	ON	ON	ON	ON
ø3	OFF	OFF	OFF	ON
ø4	OFF	OFF	OFF	OFF

• Output pulse sequence

- In valve close state: 4 → 3 → 2 → 1 → 4
- In valve open state: 1 → 2 → 3 → 4 → 1

- * 1. If EEV open angle does not change, all of output phase will be OFF
- 2. If output phase is different or continuously in the ON state, motor will not operate smoothly and start vibrating.

• EEV valve operation

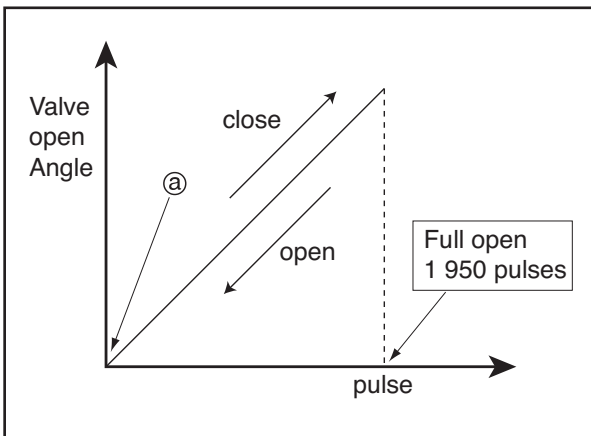

- At power ON, open angle signal of 2 000 pulses output and valve position is set to ①. If valve operates smoothly, no noise and vibration occurs and if valve is closed. noise occurs.
- Noise from EEV can be confirmed by touching the EEV surface with a screw driver and listening the EEV noise.
- If liquid refrigerant is in EEV, the noise is lower.



CAUTION

- Please process the failure with accordance to the correspond EEV as specified on the right of a table below.

Failure mode	Judgment method	Failure process
EEV mechanical part is locked.	If EEV mechanical part is locked, a driving motor rotates and makes some little noises as load is not applied. There is a problem if making the noise when EEV is completely closed or opened.	Please replace EEV.
There is a misconnected line at the EEV motor coil or a short circuiting is occurred.	Please measure the resistance between the coils (Red-white, red-orange, brown-yellow, brown-blue) using a tester.	Replace EEV
	Sub cooling EEV: Please measure the resistance between the coils (Red-white, red-yellow, red-orange, red-blue) using a tester. It is normal if the resistance is within $52 \Omega \pm 3 \Omega$ (Based on 20 °C).	Please replace EEV coil.
	Outdoor unit EEV: Please measure the resistance between the coils (Red-white, red-orange, brown-yellow, brown-blue) using a tester. It is normal if the resistance is within $150 \Omega \pm 10 \%$.	Replace EEV
Incomplete connection of a connector or incomplete contact	<ul style="list-style-type: none"> • Please check if there is any pin that is not completely inserted to a connector and confirm the color of a connection wire visually. • Please separate the connector of a control board and check using a tester. 	Please check the part finding problems.

■ EEV coil removal method of an Sub cooling circuit

Sub cooling EEV is composed as a figure below and can be separated into a coil and a body.

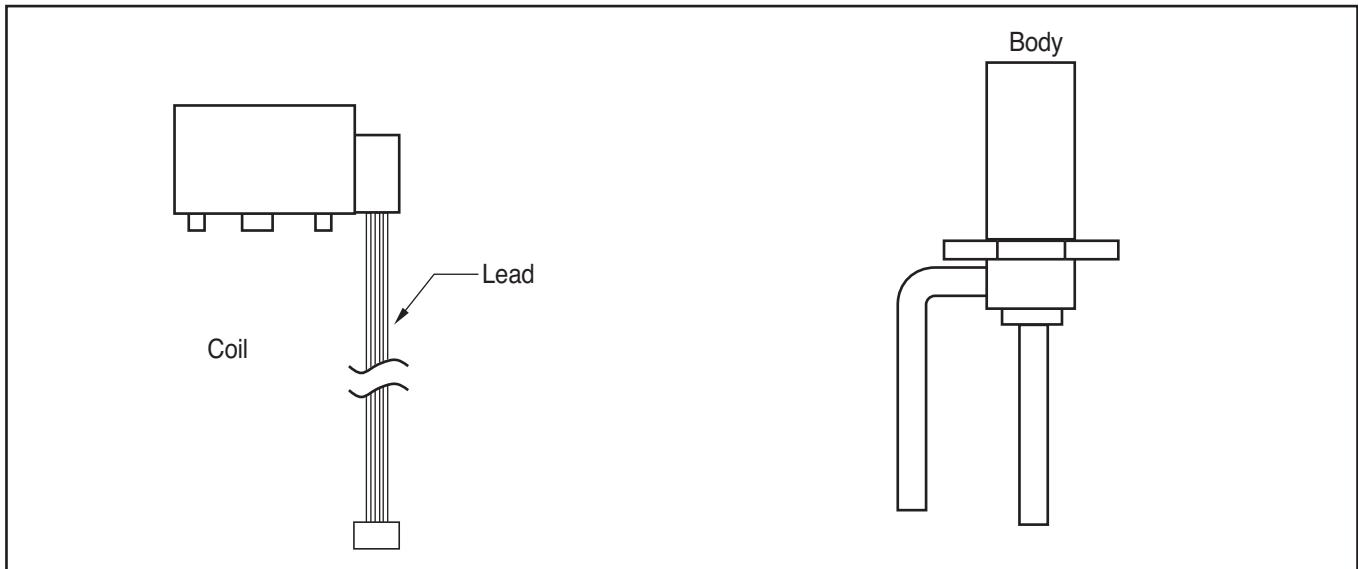

■ Coil removal method

Please hold the bottom part of a body tightly to not to be moved and take the coil out upwards.

In case where the coil is hooked to fix equipment so that it is difficult to take it out, please take the coil out after getting off from the fix equipment by rotating the coil left and right.

In case of taking the coil out without holding the body part, the pipe can be banded due to the excess force applying on the pipe. Therefore, please hold the body part tightly to not to be moved.

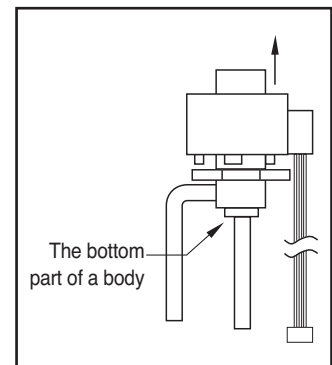

■ Coil installation method

Please hold the bottom part of a body tightly to not to be moved and insert the coil from the top.

Please insert the fixed equipment of a coil to the groove of a body part correctly. (There are 4 grooves where the fixed equipment of a coil is inserted at the edges of a body part and it is okay to insert any places out of 4 grooves.)

Please be attention not to apply excess force to the wires or to twist with the body part.)

In case of inserting the coil without holding the body part, the pipe can be banded due to the excess force applying on the pipe. Therefore, please hold the body part tightly to not to be moved and then insert the coil.

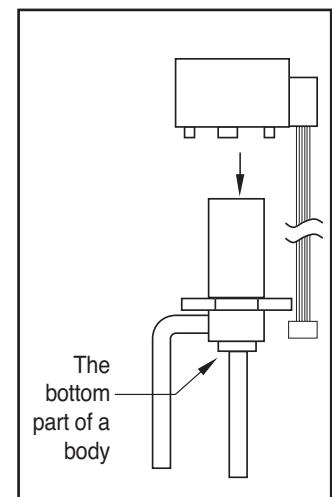

■ 3 Phase bridge diode inspection method

Internal circuit diagram

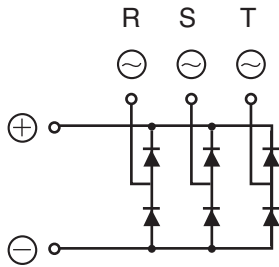

Appearance

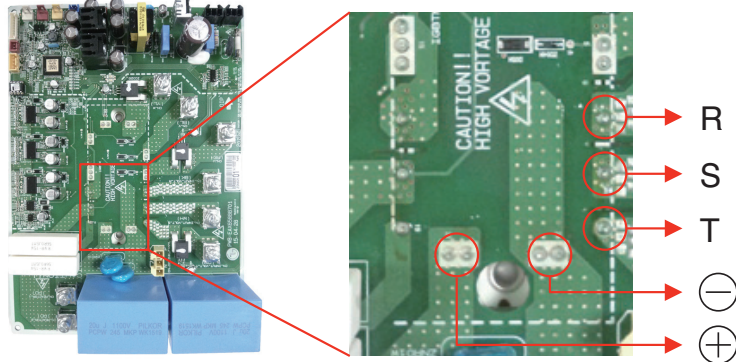

1. Wait until Comp PCB DC voltage gets discharged, after the main power switch off (10 min).
2. Pull out all the connector connected with Inverter PCB.
3. Set multi tester in diode mode.
4. Measured value should be 0.4~0.7V measuring as below table.
5. In case the measured value is different from the table, set multi tester to resistance mode and measure. If the value is short (0 Ω) or Open (hundreds MΩ), the Inverter PCB needs to be replaced.
6. In case that bridge diode is damaged, check if the Inverter PCB needs to be replaced.

Diode terminal Tester terminal	+ terminal: black(-)	- terminal: red(+)
	R(~) : red(+)	0.4 V ~ 0.7 V
S(~) : red(+)	0.4 V ~ 0.7 V	-
T(~) : red(+)	0.4 V ~ 0.7 V	-
R(~) : black(-)	-	0.4 V ~ 0.7 V
S(~) : black(-)	-	0.4 V ~ 0.7 V
T(~) : black(-)	-	0.4 V ~ 0.7 V

* Red(+) and black(-) are the measuring terminals of multi tester.

CAUTION

- Check the electric parts of c/box, 10 minutes after switching off the main supply and checking DC voltage is discharged. Otherwise, there is chance of getting electric shock.
- There is chance of electric shock by charged voltage.

■ Inverter IPM inspection method

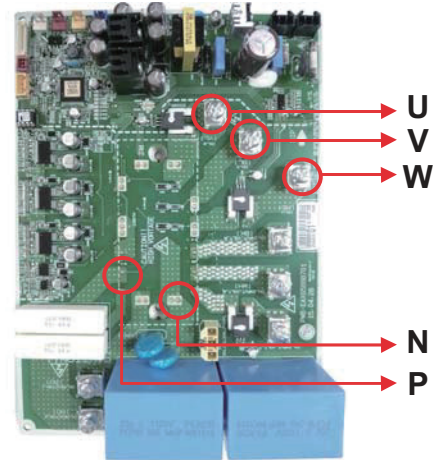
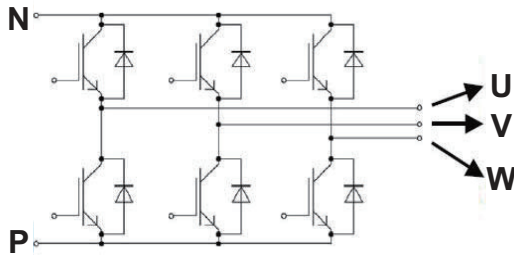

1. Wait until the Inverter PCB DC voltage is discharged after main power off. (10 min.)
2. Pull out all the connector connected with Inverter PCB.
3. Set multi tester to resistance mode.
4. Measured value should be 0.2 ~ 0.6 V measuring as below table.
5. In case that the measured value is different from the table, set multi tester to resistance mode and measure.
If the value is short (0 Ω) or Open (hundreds MΩ), Inverter PCB needs to be replaced.
6. In case measured value is different from the table, PCB needs to be replaced.(PCB damaged).

	P terminal : black (-)	N terminal : red (-)
U terminal : red(+)	0.2 ~ 0.6 V	-
V terminal : red(+)	0.2 ~ 0.6 V	-
W terminal : red(+)	0.2 ~ 0.6 V	-
	P terminal : red(+)	N terminal : red (+)
U terminal : black(-)	-	0.2 ~ 0.6 V
V terminal : black(-)	-	0.2 ~ 0.6 V
W terminal : black(-)	-	0.2 ~ 0.6 V

* Red(+) and black(-) are the measuring terminals of multi tester.

■ Fan IPM inspection method

1. Wait until the Fan PCB DC voltage gets discharged after the main power off. (10 min.)
2. Pull out the DC connector and U,V,W Fan connector connected with Fan PCB.
3. Set multi tester in resistance mode .
4. If the measured value between P and N terminal of IPM is short (0 Ω), Fan PCB needs to be replaced because the IPM part is damaged..
5. If the measured value is different from below table, Fan PCB needs to be replaced.

	P terminal : black (-)	N terminal : red (-)
U terminal : red(+)	4.98 MΩ ± 10% (25°C)	5.85 MΩ ± 10% (25°C)
V terminal : red(+)	4.98 MΩ ± 10% (25°C)	5.85 MΩ ± 10% (25°C)
W terminal : red(+)	4.98 MΩ ± 10% (25°C)	5.85 MΩ ± 10% (25°C)
	P terminal : red(+)	N terminal : red (+)
U terminal : black(-)	4.49 MΩ ± 10% (25°C)	0.72 MΩ ± 10% (25°C)
V terminal : black(-)	4.49 MΩ ± 10% (25°C)	0.72 MΩ ± 10% (25°C)
W terminal : black(-)	4.49 MΩ ± 10% (25°C)	0.72 MΩ ± 10% (25°C)

* Red(+) and black(-) are the measuring terminals of multi tester.

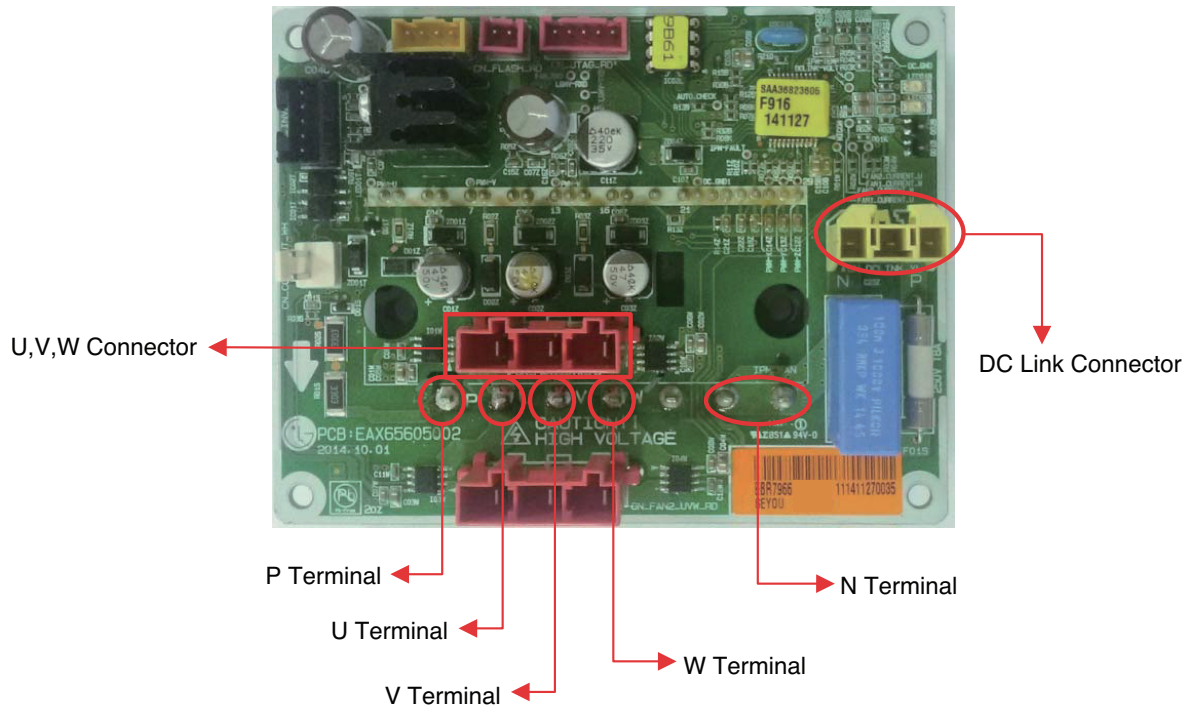

UXB Fan PCB

■ Pressure Sensor(High/Low Pressure Sensor)

Connect manifold gauge to the service valve of outdoor unit, and compare the output of high pressure sensor to the output of low pressure sensor to detect the defect.

below) Compare the output of pressure sensor to the output of manifold gauge pressure using the table below. Read output signal clearly between black and white wire as the composition of pressure sensor.

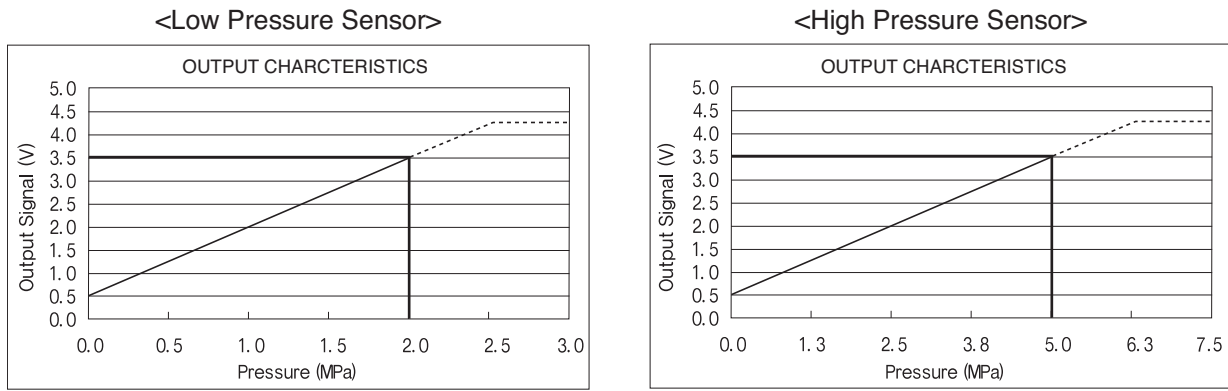

- 1) If the pressure of manifold gauge is 0~1 kg/cm², it indicates the pressure got lower due to the leakage of refrigerant. Find the place of leakage and fix it.
- 2) If the difference of the outputs of high and low pressure is in the range of 1 kg/cm², the pressure sensor is normal.
- 3) If the difference of the outputs of high and low pressure is over 1 kg/cm², the pressure sensor is out of order, it need to be replaced.
- 4) The composition of pressure sensor

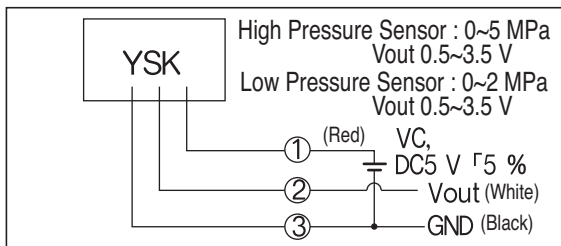

The pressure sensor is composed like the circuit picture shown above. If DC 5 V voltage flows on red and black wire, voltage would be made between the white and black wire. The pressure which is equivalent to the pressure output is shown in the table above.

■ Outdoor Fan

- 1) The outdoor fan is controlled by the inverter motor which can control the number of rotations.
- 2) The outdoor fan is controlled by the high/low pressure of the outdoor unit after the operation of compressor.
- 3) There is possibility that the outdoor fan does not operate due to low capacity operation or low outdoor temperature even if the compressor is operating. This does not mean breakdown of the unit, the fan will start operating if it reaches the set point.

■ Temperature Sensor

- 1) outdoor temperature sensor : TH1
- 2) Suction pipe(S-pipe) temperature sensor : TH2
- 3) Discharge pipe(D-pipe) temperature sensor : TH3
- 4) Outdoor heat exchanger (center of condenser) temperature sensor :TH2
 1. Check the condition of installation and the contact of temperature sensor.
 2. Check whether the connector contact of temperature sensor is normal.
 3. Measure the resistance of temperature sensor.

	TH1	TH2	TH3
Resistance	10 kΩ ±1 %(25 °C)	5 kΩ ±1 %(25 °C)	200 kΩ ±1 %(25 °C)
	1.07 kΩ ±3.3 %(85 °C)	535 kΩ ±3.3 %(85 °C)	28 kΩ ±7.7 %(85 °C)

■ Inverter compressor

M chiller is composed of 2 inverter scroll compressors.

If occurring an error regarding a compressor and power while operating, please check and confirm following an order below.

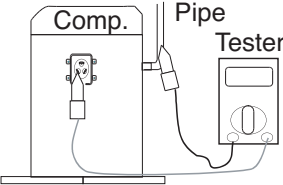
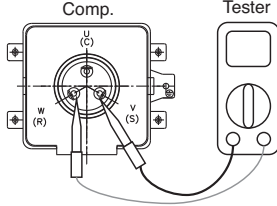
Items to be confirmed	Symptom	Treatment												
How long has the power supplied before an operation?	1) When supplying for 12 hours or more than that	• Please go to number 2.												
	2) When supplying for less than 12 hours	• Please permit the power for a designated time (12 hours) and then go to number 2.												
Does failure appears again when starting operation?	1) The compressor stops and same error appears again.	• Please confirm whether or not IPM is failed.												
Method to measure insulation resistance  Figure 1.	2) If output voltage of the inverter is stably output. *1	* Check coil resistor and insulation resistor. If normal, restart the unit. If same symptom occurs, replace the compressor. * Insulation resistor: 50 MΩ or more * Coil resistor (below table) JQC068MA* <table border="1"> <thead> <tr> <th>Temp.</th> <th>25 °C</th> <th>75 °C</th> </tr> </thead> <tbody> <tr> <td>U-V</td> <td>0.216±7% Ω</td> <td>0.258±7% Ω</td> </tr> <tr> <td>V-W</td> <td>0.216±7% Ω</td> <td>0.258±7% Ω</td> </tr> <tr> <td>W-U</td> <td>0.216±7% Ω</td> <td>0.258±7% Ω</td> </tr> </tbody> </table>	Temp.	25 °C	75 °C	U-V	0.216±7% Ω	0.258±7% Ω	V-W	0.216±7% Ω	0.258±7% Ω	W-U	0.216±7% Ω	0.258±7% Ω
Temp.			25 °C	75 °C										
U-V	0.216±7% Ω	0.258±7% Ω												
V-W	0.216±7% Ω	0.258±7% Ω												
W-U	0.216±7% Ω	0.258±7% Ω												
Method to measure coil resistance  Figure 2.	3) If output voltage of the inverter is unstable or it is 0V. (When incapable of using a digital tester)	* Check the IPM. If the IPM is normal, replace the inverter board. * Check coil resistor and insulation resistor.												

*1 [Matters that require attention when measuring a voltage and current of an inverter power circuit]

The measured value can differ depending upon measurement equipment and a measurement circuit.

Especially, an output voltage of an inverter has an pulse type pattern, the output frequency is also changed.

Additionally, the measured value greatly differs depending upon measurement equipment.

- 1) When checking whether or not an output voltage of an inverter is consistent, (When comparing the relative voltages between the lines) if a portable tester is used, please be sure to use an analog tester. Please keep in mind especially in case of having a low inverter output frequency, using a portable tester, having a large change of measured voltage value between different lines, appearing an imaginary same value actually, and having a risk judging as an inverter failure.
- 2) When measuring an output voltage value of an inverter (When measuring an absolute value), if a commercial frequency measurer is used, a rectification voltmeter (—▶—) can be used. An accurate measured value can't be obtained by using a regular portable tester.
(Both analog and digital)

■ Fan Motor

Checking Item	Symptom	Countermeasure
<p>(1) The fan motor does not operate. Does failure appears again when starting operation?</p> <p>(2) Vibration of the fan motor is large.</p>	1) When power supply is abnormal	<p>* Modify connection status in front of or at the rear of the breaker, or if the power terminal console is at frosting condition.</p> <p>* Modify the power supply voltage is beyond specified scope.</p>
	2) For wrong wiring	<p>* For following wiring.</p> <ol style="list-style-type: none"> 1. Check connection status. 2. Check contact of the connector. 3. Check that parts are firmly secured by tightening screws. 4. Check connection of polarity. 5. Check short circuit and grounding.
	3) For failure of motor	<p>* Measure winding resistance of the motor coils. - $14.2 \Omega \pm 7 \%$ (@25 °C)</p>
	4) For failure of circuit board	<p>Replace the circuit board in following procedures if problems occur again when powering on and if there are no matters equivalent to items as specified in above 1) through 4). (Carefully check both connector and grounding wires when replacing the circuit board.)</p> <ol style="list-style-type: none"> 1. Replace only fan control boards. If starting is done, it means that the fan control board has defect. 2. Replace both fan control board and the CYCLE Main Board If starting is done, it means that the Main CYCLE Board has defect. 3. If problems continue to occur even after counter-measure of No.1 and No.2, it means that both boards has defect.

■ Compressor

Compressor specification applying M chiller is as following as below. When there is a problem in a compressor, please check by referring to the compressor specification.

Model name		JQC068MAA
Compony		LG
Form		Inverter scroll
Compression volume (cm3/rev)		62.1
Refrigerating machine oil		FW68D(PVE)
Weight		31.8 kg
Internal diameter of suction inlet		22.6 mm
Internal diameter of discharge outlet		16.05 mm
Motor	Number of poles	6 poles
	Insulation grade	B Class
Performance (Based on 60Hz)	Cooling capacity (W)	24 911
	Power consumption (W)	4 060
	Operation current	12.6
Operation frequency range		12~160 Hz

Alarm

An explanation regarding a failure is as following below

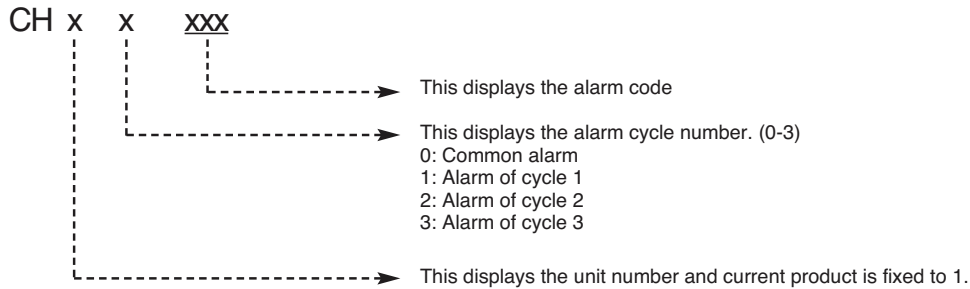

Failure code	Failure name	
	Occurrence condition	
	Control when occurring	Removal condition
CHxx001	Air temperature sensor error	
	Open/Short of an air temperature sensor	
	Product stop	Automatic return to a normal condition
CHxx003	HMI communication error	
	In case where the communication between HMI and a chiller controller is not performed for 180 seconds.	
	Product stop	Automatic return to a normal condition
CHxx005	Communication error with a cycle control box	
	In case where the communication between a controller and a cycle control box is not performed for 30 seconds.	
	Product stop	Automatic return to a normal condition
CHxx009	Remote communication error	
	After a communication of a remote control bus status at first, the communication between external equipment and a modbus is not performed for 180 seconds.	
	Product stop	Automatic return to a normal condition
CHxx011	Load water pump interlocking error	
	When the pump contact input is off for 3 seconds when starting or during operation and this condition occurs 3 times within one hour, or pump contact input is off for more than 9 seconds.	
	Product stop	HMI Reset button press

The phenomena from main component failure

Failure code	Failure name	
	Occurrence condition	
	Control when occurring	Removal condition
CHxx013	Load water flow switch error	
	During a mobile and an operation, in case of detecting the turning off of load flow switch for 3 seconds, 3 times of accumulation occurs within a hour. When occurring turning off phenomenon for more than 9 seconds total within a hour	
	Product stop	HMI Reset button press
CHxx015	Remote alarm	
	When performing a remote mode of a control mode, a signal of the hardware connection gets short gradually	
	Product stop	Automatic return to a normal condition
CHxx021	Inverter compressor IPM fault	
	Inverter compressor drive IPM defect/ Inverter compressor defect	
	Correspond cycle stop	Automatic return to a normal condition
CHxx022	Inverter compressor input over current	
	Inverter compressor input over current occurrence	
	Correspond cycle stop	Automatic return to a normal condition
CHxx023	Inverter compressor DC Link low voltage	
	DC voltage charge defect	
	Correspond cycle stop	Automatic return to a normal condition
CHxx024	Cycle high pressure switch operation	
	High pressure switch operates due to abnormal high pressure	
	Stop applicable cycle	Automatically return to normal condition
CHxx025	High voltage/ low voltage of input voltage	
	Voltage allowance of input voltage excess/under	
	Correspond cycle stop	Automatic return to a normal condition
CHxx026	Inverter compressor restart fail error	
	Initial start-up fail due to defect of a compressor	
	Correspond cycle stop	Automatic return to a normal condition

Failure code	Failure name	
	Occurrence condition	
	Control when occurring	Removal condition
CHxx028	Inverter DC link high voltage error	
	Defect from DC voltage and over-charge	
	Stop applicable cycle	Automatically return to normal condition
CHxx029	Inverter compressor over current	
	CT value excess	
	Correspond cycle stop	Automatic return to a normal condition
CHxx032	Surge in inverter #1, #2 compressor discharge temperature	
	Surge in inverter #1, #2 compressor discharge temperature	
	Stop applicable cycle	Automatically return to normal condition
CHxx034	Compressor discharge pressure excessive increase	
	High pressure side pressure excessive increase occurrence	
	Correspond cycle stop	Automatic return to a normal condition
CHxx035	Compressor inlet pressure excessive decrease	
	Low pressure side pressure excessive decrease occurrence	
	Correspond cycle stop	Automatic return to a normal condition
CHxx036	Low pressure ratio error	
	Low pressure ratio error occurrence	
	Correspond cycle stop	Automatic return to a normal condition
CHxx040	Inverter compressor CT sensor error	
	Inverter compressor CT sensor is short/open	
	Stop applicable cycle	Automatically return to normal condition
CHxx041	Inverter compressor discharge temperature sensor error	
	Inverter compressor discharge temperature sensor is short/open	
	Stop applicable cycle	Automatically return to normal condition

The phenomena from main component failure

Failure code	Failure name	
	Occurrence condition	
	Control when occurring	Removal condition
CHxx042	Low pressure sensor error	
	Low pressure sensor is short/open	
	Stop applicable cycle	Automatically return to normal condition
CHxx043	High pressure sensor error	
	High pressure sensor is short/open	
	Stop applicable cycle	Automatically return to normal condition
CHxx045	Heat exchanger temperature sensor error	
	Heat exchanger temperature sensor is short/open	
	Stop applicable cycle	Automatically return to normal condition
CHxx046	Suction temperature sensor error	
	Suction temperature sensor is short/open	
	Stop applicable cycle	Automatically return to normal condition
CHxx050	Chiller 3 phase power missing phase	
	Chiller 3 phase power missing phase	
	Stop applicable cycle	Automatically return to normal condition

The phenomena from main component failure

Failure code	Failure name	
	Occurrence condition	
	Control when occurring	Removal condition
CHxx052	Communication error	
	Communication defect occurrence	
	Correspond cycle stop	Automatic return to a normal condition
CHxx057	Communication defect between an inverter board and a main board	
	Communication defect occurrence with an inverter control part	
	Correspond cycle stop	Automatic return to a normal condition
CHxx059	Installation Failure of Series Model Outdoor Unit	
	Installation Failure of Series Model Outdoor Unit	
	Stop applicable cycle	Automatically return to normal condition
CHxx060	Inverter PCB EEPROM error	
	Inverter PCB EEPROM error	
	Correspond cycle stop	Automatic return to a normal condition
CHxx062	Surge in inverter board IPM temperature	
	Surge in inverter board IPM temperature	
	Correspond cycle stop	Automatic return to a normal condition
CHxx065	Inverter IPM temperature sensor defect	
	Inverter IPM temperature sensor Short/Open	
	Correspond cycle stop	Automatic return to a normal condition
CHxx067	Fan lock	
	Fan locked	
	Stop applicable cycle	Automatically return to normal condition

The phenomena from main component failure

Failure code	Failure name	
	Occurrence condition	
	Control when occurring	Removal condition
CHxx075	Fan CT sensor error	
	Fan CT sensor is short/open	
	Stop applicable cycle	Automatically return to normal condition
CHxx077	Fan over-voltage error	
	Fan over-voltage	
	Stop applicable cycle	Automatically return to normal condition
CHxx079	Fan start failure error	
	Fan start failure	
	Stop applicable cycle	Automatically return to normal condition
CHxx086	CYCLE Main PCB EEPROM error	
	Main PCB EEPROM access error	
	Stop applicable cycle	Automatically return to normal condition
CHxx087	Fan PCB EEPROM error	
	Fan PCB EEPROM access error	
	Stop applicable cycle	Automatically return to normal condition

The phenomena from main component failure

Failure code	Failure name	
	Occurrence condition	
	Control when occurring	Removal condition
CHxx090	Individual Inletwater temperature sensor error	
	Individual Inletwater temperature sensor is short/open	
	Stop applicable cycle	Automatically return to normal condition
CHxx091	Individual Outletwater temperature sensor error	
	Individual Outletwater temperature sensor is short/open	
	Stop applicable cycle	Automatically return to normal condition
CHxx104	Communication Error between Outdoor Unit	
	Communication Error between Outdoor Unit	
	Stop applicable cycle	Automatically return to normal condition
CHxx105	Fan board communication error	
	Fan board communication error	
	Stop applicable cycle	Automatically return to normal condition
CHxx106	Fan PCB IPM fault	
	Fan PCB IPM fault	
	Stop applicable cycle	Automatically return to normal condition
CHxx107	Fan DC link low voltage error	
	Fan DC link low voltage	
	Stop applicable cycle	Automatically return to normal condition

The phenomena from main component failure

Failure code	Failure name	
	Occurrence condition	
	Control when occurring	Removal condition
CHxx113	Liquid pipe temperature sensor error	
	Liquid temperature sensor is short/open	
	Stop applicable cycle	Automatically return to normal condition
CHxx114	Sub cooling Suction temperature sensor error	
	Sub cooling Suction temperature sensor is short/open	
	Stop applicable cycle	Automatically return to normal condition
CHxx115	Sub cooling outlet pipe temperature sensor error	
	Sub cooling outlet pipe temperature sensor Short/Open	
	Correspond cycle stop	Automatic return to a normal condition
CHxx145	Main Board - External Board communication Error	
	Main Board - External Board communication Error	
	Stop applicable cycle	Automatically return to normal condition
CHxx150	Liquid Compression Prevention Error	
	Liquid Compression Prevention Error	
	Stop applicable cycle	Automatically return to normal condition
CHxx151	4-way valve switching error	
	Mode switching failed	
	Corresponding cycle stopped	Automatic return to the normal condition
CHxx180	Plate type heat exchanger frozen	
	-Cooling: Individual output water temperature is maintained at 3°C or lower for at least 10 seconds. -Heating: Individual output water temperature is maintained at 60°C or higher for at least 10 seconds. -Common in heating and cooling: The difference in input and output water temperatures is maintained at 7°C or higher for at least 30 seconds.	
	Stop applicable cycle	Automatically return to normal condition

The phenomena from main component failure

Failure code	Failure name	
	Occurrence condition	
	Control during error	Cancel condition
CHxx193	Surge in fan board heat emitting plate temperature	
	Surge in fan board heat sink temperature	
	Stop applicable cycle	Automatically return to normal condition
CHxx194	Fan board heat emitting plate temperature sensor error	
	Fan board heat emitting plate temperature sensor is short/open	
	Stop applicable cycle	Automatically return to normal condition

8. Error code check

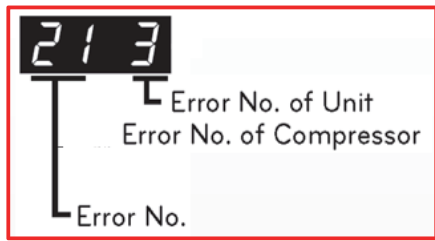

Error No.	Error Type	Error Point	Main Reasons
01	Air temperature sensor error	Temperature sensor Open/Short	1. Sensor connector~ Chiller board contact defect 2. Chiller board defect 3. Sensor defect (Main cause)

Failure diagnosis method

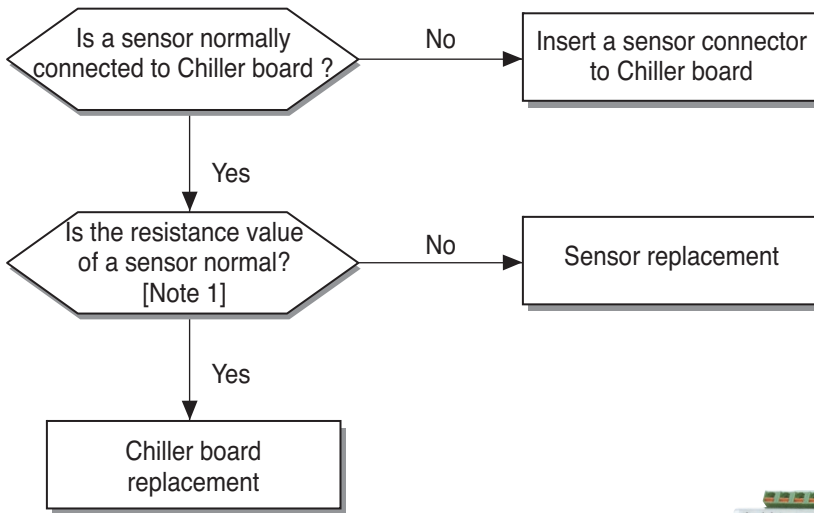

[Note 1] An error is occurred in case of more than 100 kΩ (Open) or less than 100 Ω (Short)

Reference: A temperature sensor is normal if a resistance value changes depending upon the temperature and next resistance value is shown based on the current temperature (±5% deviation)
 Air temperature sensor: 10 °C = 20.7 kΩ : 25 °C = 10 kΩ : 50 °C = 3.4 kΩ
 Pipe temperature sensor: 10 °C = 10 kΩ : 25 °C = 5 kΩ : 50 °C = 1.8 kΩ

[Note 2] When replacing the chiller board, it is necessary to set the product capacity.

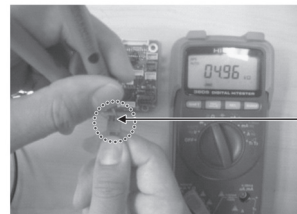
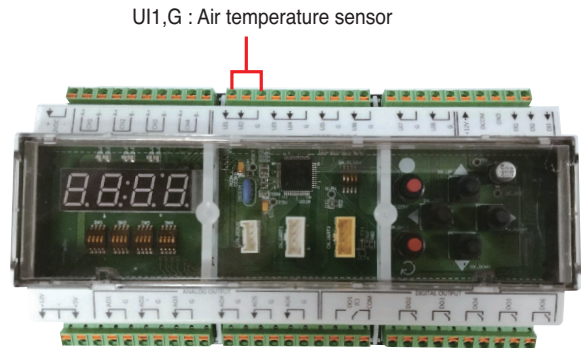
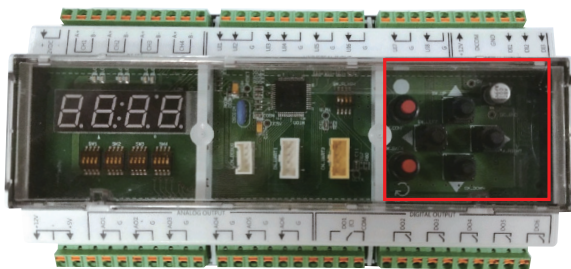

Temperature sensor resistance measurement

How to set the Capacity of product

- 1) Press the down (▼) button and the right (▶) button at the same time for 5 seconds.
- 2) Press the up/down (▲▼) button to move to FN01.
- 3) Press the SW_CONF button.
- 4) Press the left and right (◀▶) buttons to set the Capacity of product.
- 5) It is set by pressing the SW_CONF button.
- 6) SW_BACK (red key) input

Model	ACHH020	ACHH023	ACHH033	ACHH040	ACHH045
Capacity	HP20	HP23	HP33	HP40	HP45

Error No.	Error Type	Error Point	Main Reasons
03	HMI communication error	In case where the communication between HMI and a chiller board is not performed for 30 seconds	1. Communication polarity connection defect 2. Address setting non-agreed 3. Chiller PCB defect 4. HMI defect

Failure diagnosis method

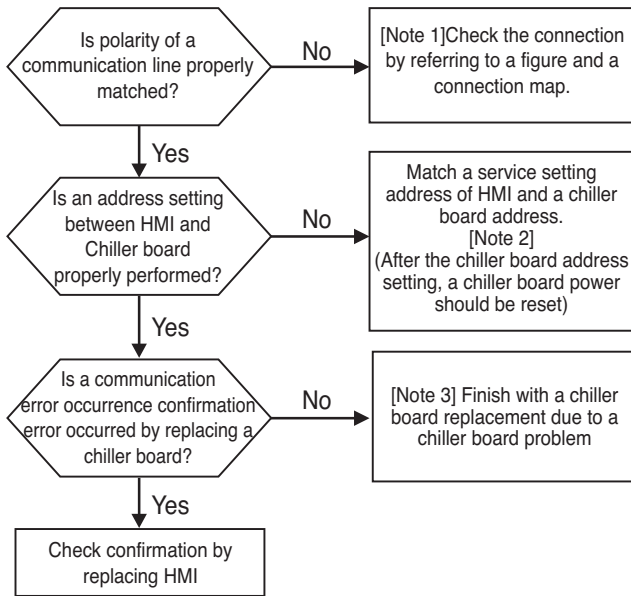

[Note 1] Insert a terminal paying attention to the communication polarity as a figure.

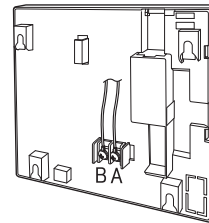

[Note 3] When replacing the chiller board, it is necessary to set the product capacity.

[Note 2] Confirm an address by confirming below Chiller board setting

Option Setting

Press SW_CONF Button to move to 0 Level Setting Screen.



Press Up or Down (▲▼) Button to go to a desired function.

If the desired function shows, press SW_COMF Button.

Then, the Screen moves to 1 Level Setting.

Press Left or Right (◀▶) Buttons to go to a desired function. And Press SW_COMF Button to set the function.

To go to the previous, press SW_BACK Button.

Description	Screen Displays(0 Level)				Screen Displays(1 Level)			
Central Control Address	A	D	D	R				1

The product address can be set for communication with other communication devices. The address can Be set by selecting values from 1-247.

Error code check

Error No.	Error Type	Error Point	Main Reasons
05	Communication error with cycle PCB	In case where a cycle PBC signal is not received at a chiller board	1. In case where a communication line is not connected 2. In case where a communication line is disconnected 3. Communication circuit obstacle 4. In case where separation distance between a power line and a communication line is not enough

Failure diagnosis method

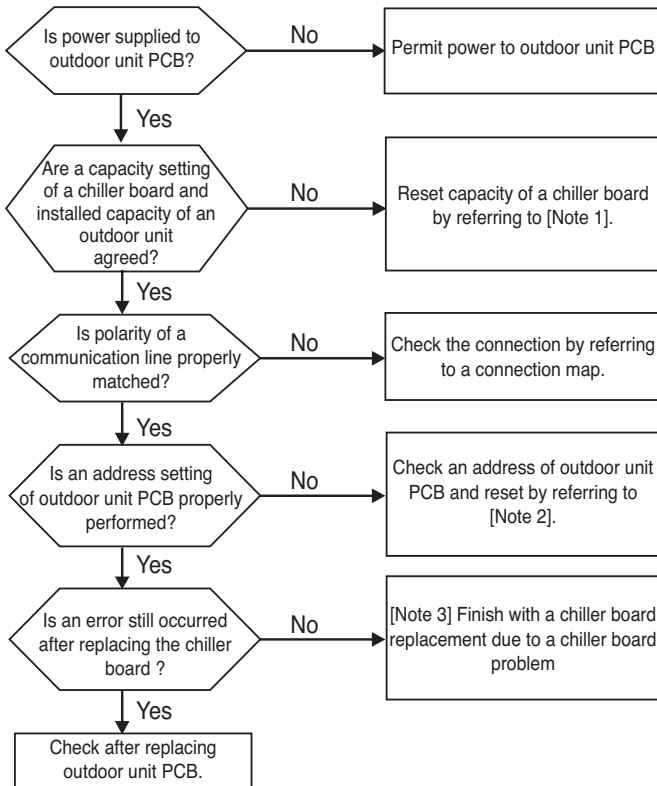

[Note 1] Confirm a capacity of product by confirming below chiller board setting.

Option Setting

Press SW_COMF Button to move to 0 Level Setting Screen.



<Screen>



<Button>

Press Up or Down (▲▼) Button to go to a desired function.

If the desired function shows, press SW_COMF Button.

Then, the Screen moves to 1 Level Setting.

Press Left or Right (◀▶) Buttons to go to a desired function. And Press SW_COMF Button to set the function.

To go to the previous, press SW_BACK Button.

	Description	Screen Displays(0 Level)				Screen Displays(1 Level)			
		H	P	4	0				
10	Capacity of product	C	O	4	0				

[Note 3] When replacing the chiller board, it is necessary to set the product capacity.

[Note 2] Reset the DIP switch of SW01

Confirm a switch position of a Main Board as below.

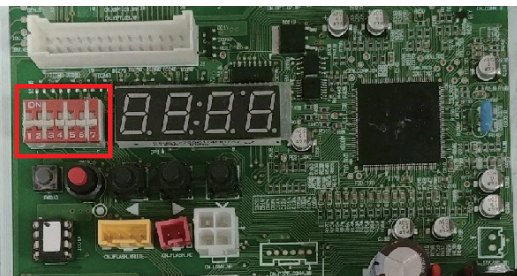

Cycle address: 1 (DIP switch: #6, #7 OFF)	SW01B
Cycle address: 2 (DIP switch: #6 ON / #7 OFF)	SW01B
Cycle address: 3 (DIP switch: #7 ON / #6 OFF)	SW01B

Error No.	Error Type	Error Point	Main Reasons
09	Remote communication error	In case where a communication is not performed for 30 seconds after occurring the first communication between a chiller board and external communication equipment	<ul style="list-style-type: none"> - Communication line polarity defect - External communication equipment power abnormality - Chiller PCB defect

■ Failure diagnosis method

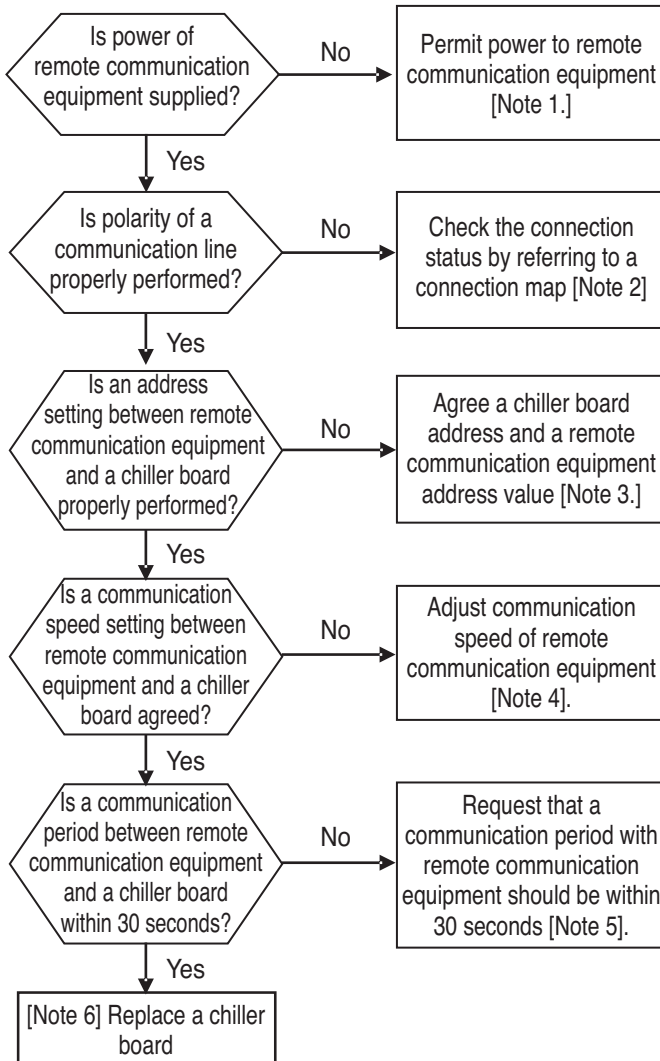

[Note 1] Confirm whether or not the power of remote automatic control equipment communicating with a chiller board or DDC is normally supplied

[Note 2] Providing 485 communication is not communicated in case where polarity doesn't match

Match providing connection map polarity A and B with the polarity of remote automatic control equipment or 485 communication terminal of DDC

Regarding connection status of external equipment, confirm the position of polarity by asking a person in charge of an automatic control or BMS company

[Note 3] Refer to the HMI communication error part regarding an address setting method since it is the same with the address setting method of HMI communication error.

Regarding an address setting of external equipment, confirm the address setting by asking a person in charge of an automatic control or BMS company

[Note 4] A communication condition provided by a chiller board is following as below

- Physical Layer: RS-485 Serial Line
- Mode: MODBUS RTU Mode
- Baud Rate: 9 600
- Parity: None Parity
- 1 Stop Bit

Agree the communication condition by providing to a person in charge of remote communication equipment

[Note 5] Request to a person in charge of remote communication equipment since an error is not occurred when communicating with a chiller board at least once in 30 seconds at the remote communication equipment

[Note 6] When replacing the chiller board, it is necessary to set the product capacity.

Error code check

Error No.	Error Type	Error Point	Main Reasons
11	Load water pump interlocking error	When the pump contact input is off for 3 seconds when starting or during operation and this condition occurs 3 times within one hour, or pump contact input is off for more than 9 seconds.	<ul style="list-style-type: none"> - Contact defect of a contact point - External pump defect - Connection defect - In case where a reset button is not pressed after occurring the pump interlocking previously

■ Failure diagnosis method

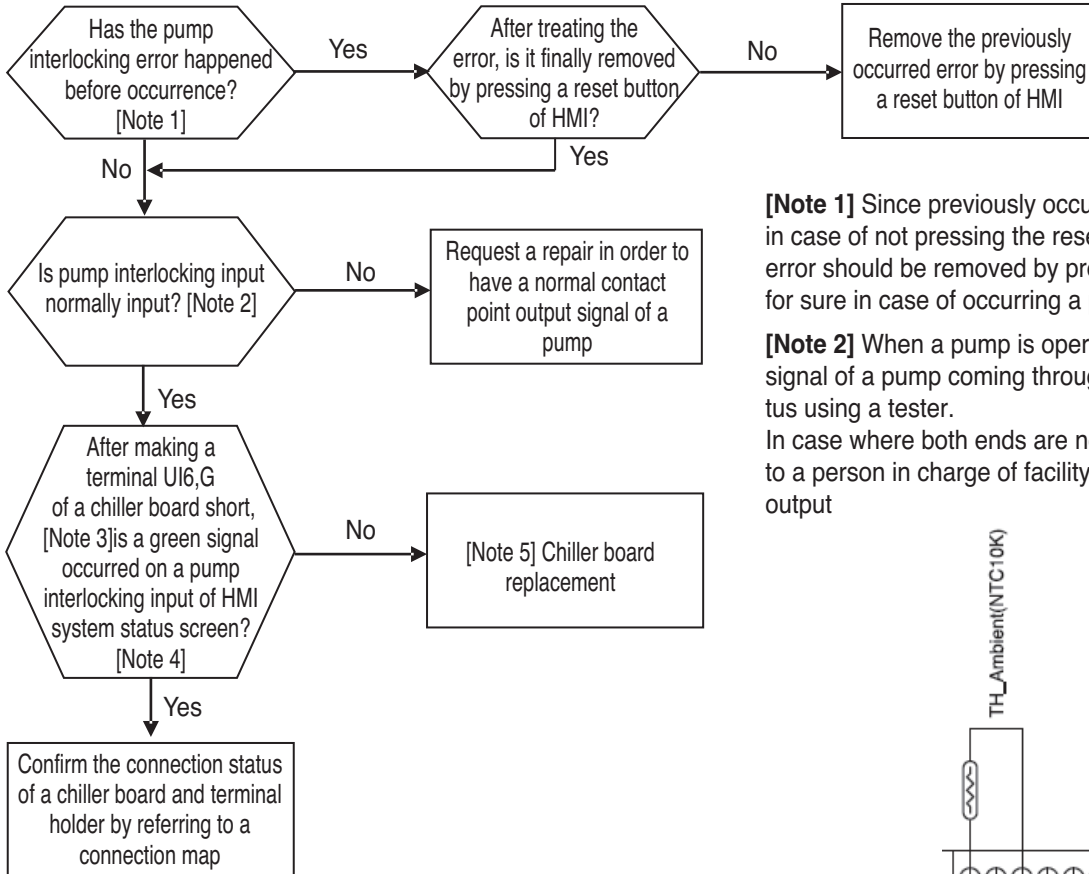

[Note 1] Since previously occurred error is not removed in case of not pressing the reset button of HMI, the error should be removed by pressing the reset button for sure in case of occurring a pump interlocking error.

[Note 2] When a pump is operating, confirm an output signal of a pump coming through UI6,G is in short status using a tester.

In case where both ends are not in short status, request to a person in charge of facility as a problem of a pump output

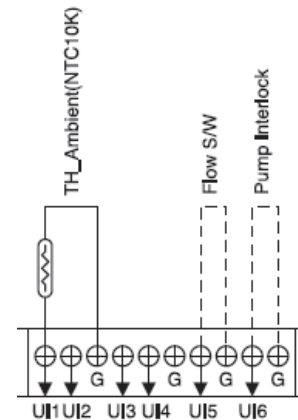

[Note 4] Confirm whether or not a pump interlock “ON” signal are occurred normally.

Unit Info.	
Pump / Flow Status	Load Water
Pump Output	OFF
Pump Interlock	OFF
Flow Switch	OFF
Capacity	80RT

[Note 5] When replacing the chiller board, it is necessary to set the product capacity.

[Note 3] Both ends short like a figure below

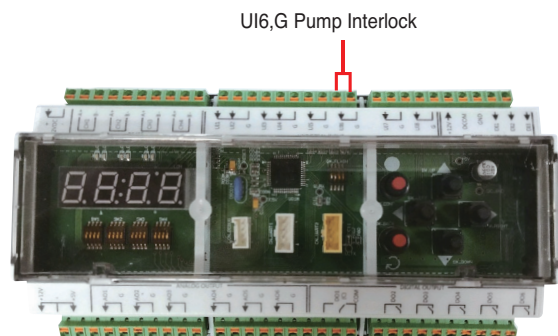

Error No.	Error Type	Error Point	Main Reasons
13	Load water flow switch error	When the flow switch is off for 3 seconds when starting or during operation and this condition occurs 3 times within one hour, or flow switch is off for more than 9 seconds.	<ul style="list-style-type: none"> - Contact defect of a contact point - Flow switch defect - Connection defect - In case where a reset button is not pressed after occurring a flow switch error previously

■ Failure diagnosis method

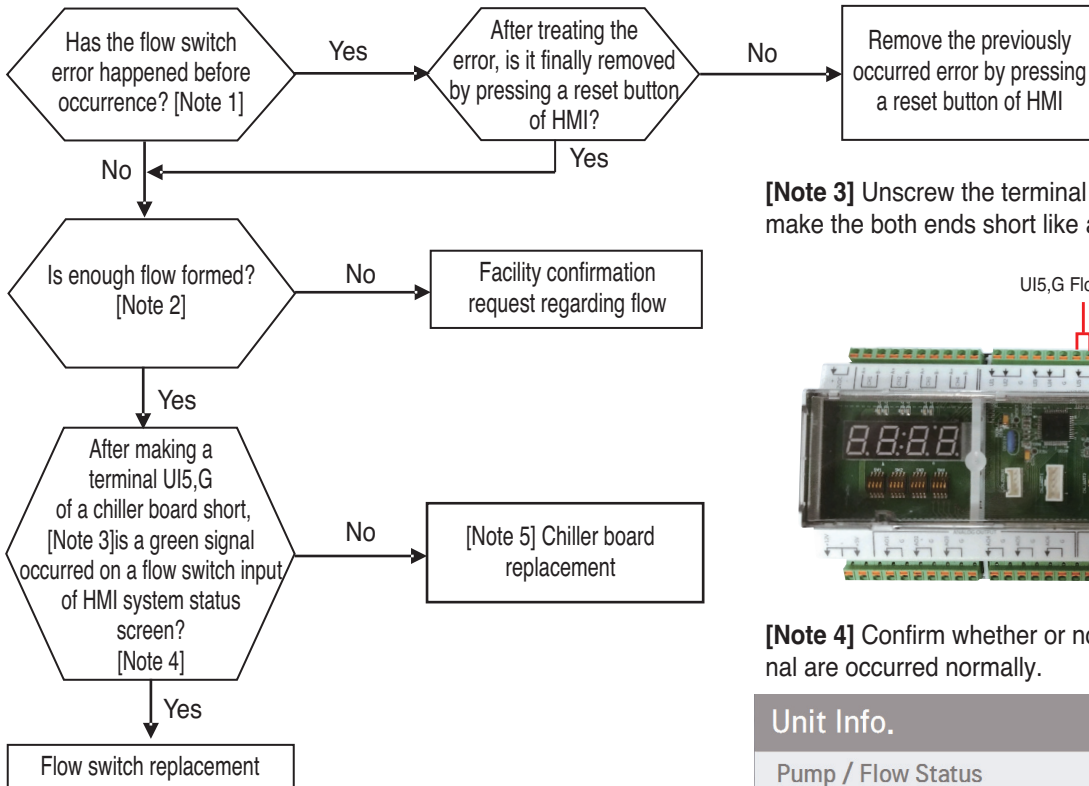

[Note 3] Unscrew the terminal holder of a board and make the both ends short like a figure below.

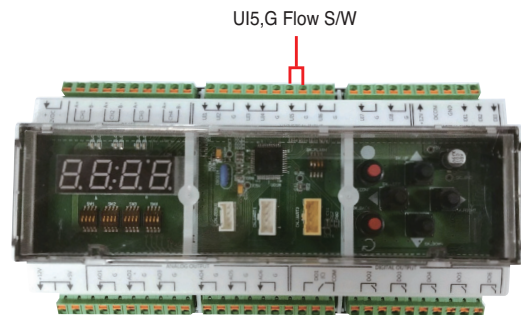

[Note 4] Confirm whether or not a flow switch “ON” signal are occurred normally.

Unit Info.	
Pump / Flow Status	Load Water
Pump Output	OFF
Pump Interlock	OFF
Flow Switch	OFF
Capacity	80RT

[Note 1] Since previously occurred error is not removed in case of not pressing the reset button of HMI, the error should be removed by pressing the reset button for sure in case of occurring a flow switch error.

[Note 2] Please include the flow formation part in the product.

[Note 5] When replacing the chiller board, it is necessary to set the product capacity.

Setting	Function
70% of rated flow	Prevent evaporator from freezing (Detects appropriate flow of cold water and stops if there is any abnormal situation)

Error code check

Error No.	Error Type	Error Point	Main Reasons
21*	Inverter PCB Assy. IGBT Fault occur	IPM self protection circuit activation (Overcurrent/IPM overheating/Vcc low voltage)	<ol style="list-style-type: none"> 1. Over current detection at Inverter compressor(U,V,W) 2. Compressor damaged (insulation damaged/Motor damaged) 3. IPM overheating (Heat sink disassembled) 4. Inverter compressor terminal disconnected or loose 5. Inverter PCB assembly damaged 6. ODU input current low

■ Error diagnosis and countermeasure flow chart

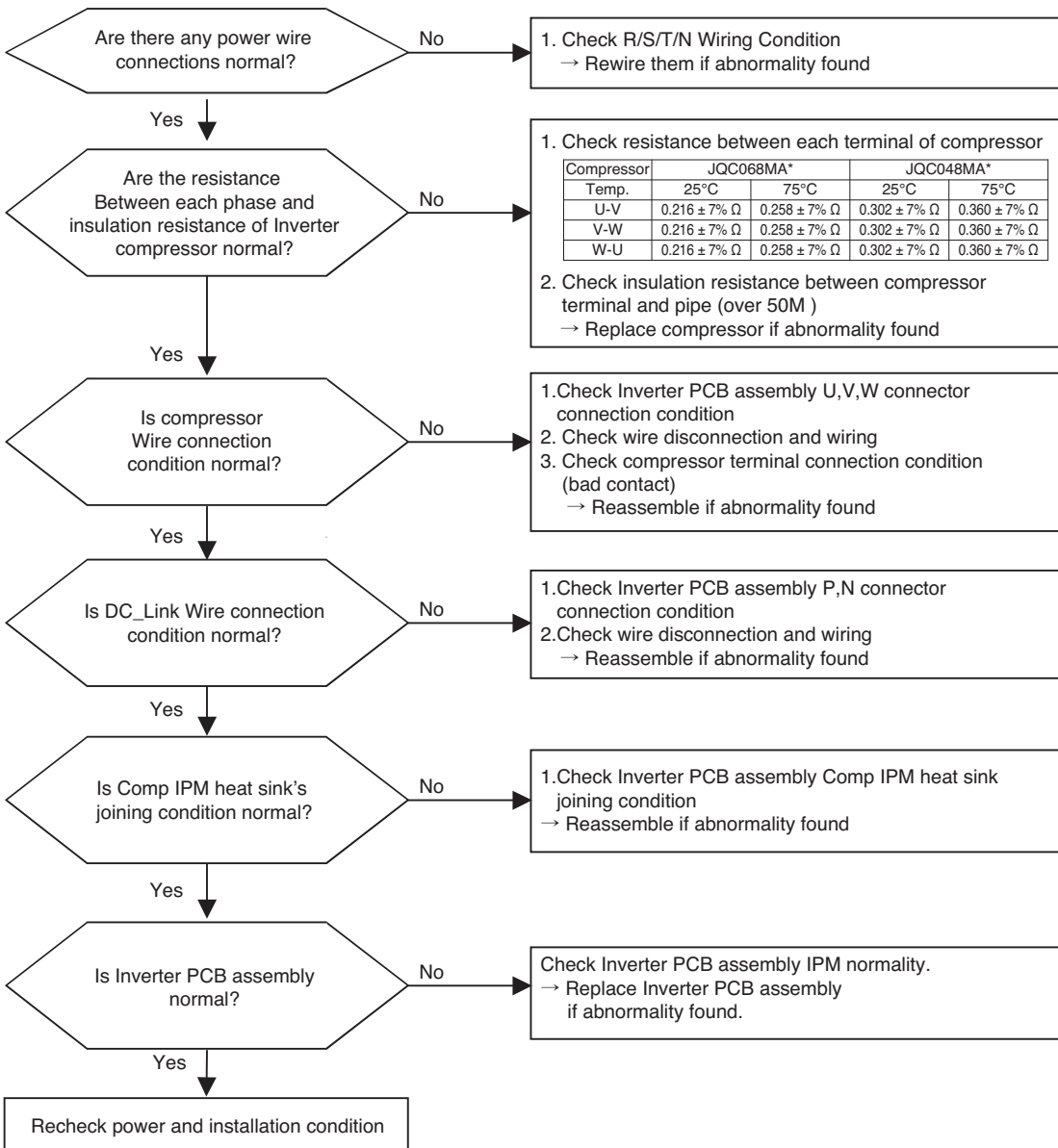

* Measuring resistance between each terminal of compressor



• IPM(IGBT) joining point

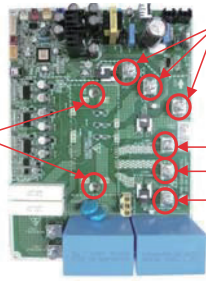

* Compressor wire connector connection point

R
S
T

• Check joining condition

• Check DC Link connector joining condition

Error code check

Error No.	Error Type	Error Point	Main Reasons
22	AC Input Current Over Error	Inverter PCB Assembly input 3 phase power current is over limited value(24 A)	<ol style="list-style-type: none"> 1. Overload operation (Pipe clogging/Covering/EEV defect/Ref. overcharge) 2. Compressor damage(Insulation damage/Motor damage) 3. Input voltage low 4. Power Line Misconnection 5. Inverter PCB Assembly damage (Input current sensing part)

■ **Error Diagnosis and Countermeasure Flow Chart**

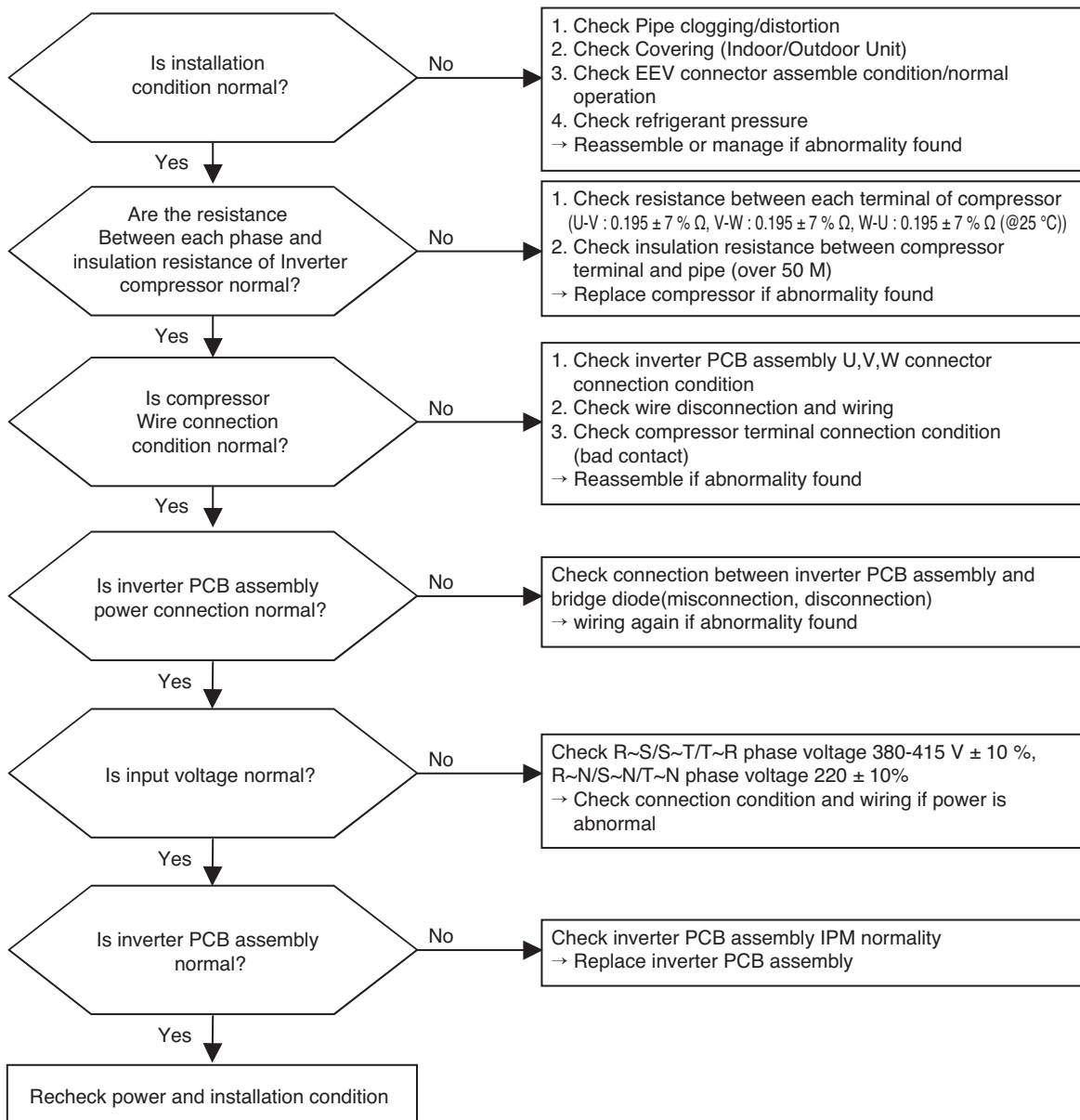

* Measuring resistance between each terminal of compressor



* Measuring input voltage



* Compressor wire connector connection

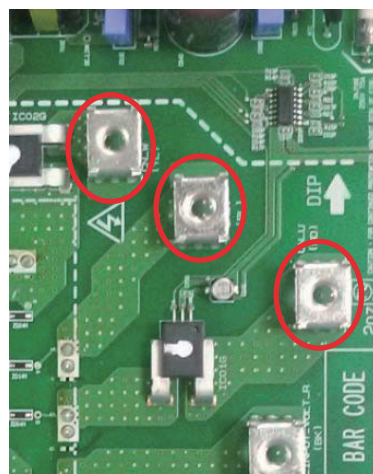

Error code check

Error No.	Error Type	Error Point	Main Reasons
23 (231)	Inverter compressor DC Link high voltage/ low voltage	Input voltage is over limited value of the product (300 V or less, 780 V or more)	<ol style="list-style-type: none"> 1. DC Link terminal misconnection/terminal contact fault 2. Starting relay damage 3. Condenser damage 4. Inverter PCB assembly damage (DC Link voltage sensing part) 5. Input voltage low

■ Error Diagnosis and Countermeasure Flow Chart

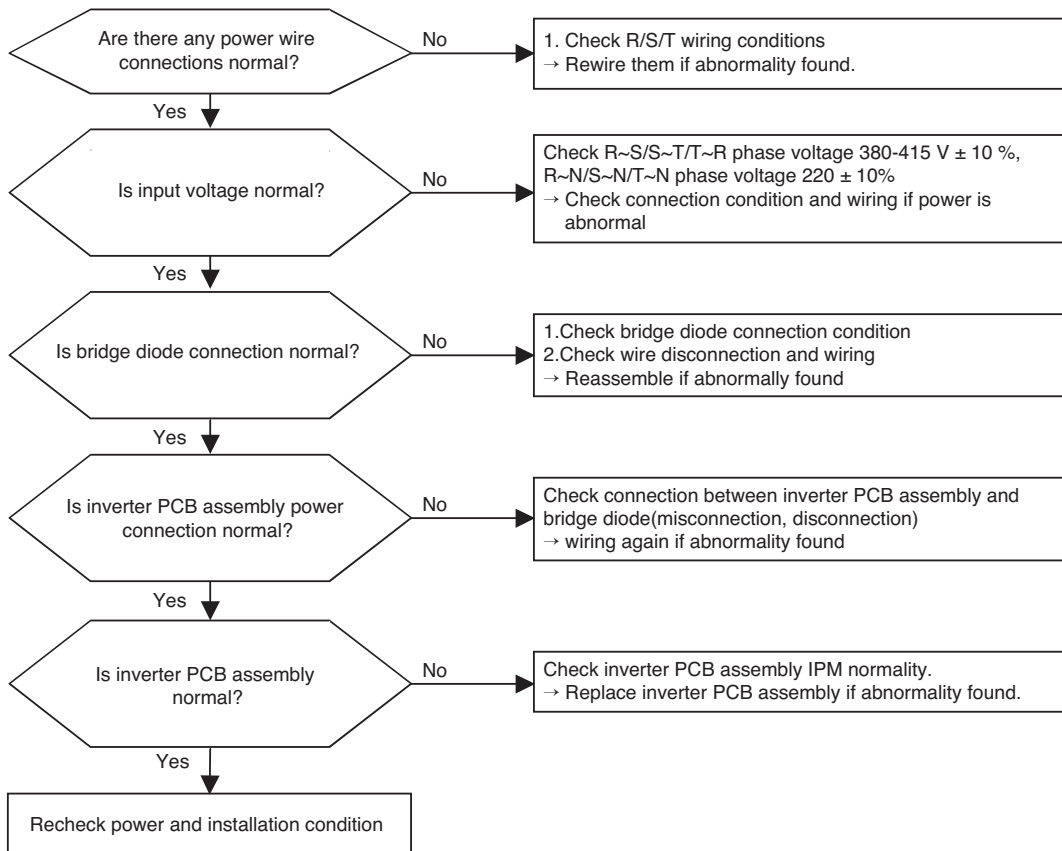

* Check DC_Link Connector joining condition

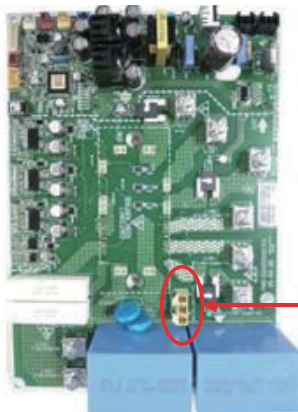

• DC Link Connector

* Measuring input voltage



Error No.	Error Type	Error Point	Main Reasons
24 (241)	Excessive rise of discharge pressure in outdoor compressor	Compressor off due to the high pressure switch in outdoor unit	<ol style="list-style-type: none"> 1. Defective high pressure switch 2. Defective fan of indoor unit or outdoor unit 3. Check valve of compressor clogged 4. Pipe distortion due to the pipe damage 5. Refrigerant overcharge 6. Defective LEV at the indoor or outdoor unit . 7. Covering or clogging(Outdoor covering during the cooling mode /Indoor unit filter clogging during the heating mode) 8. SVC valve clogging 9. Defective outdoor PCB

■ Error diagnosis and countermeasure flow chart

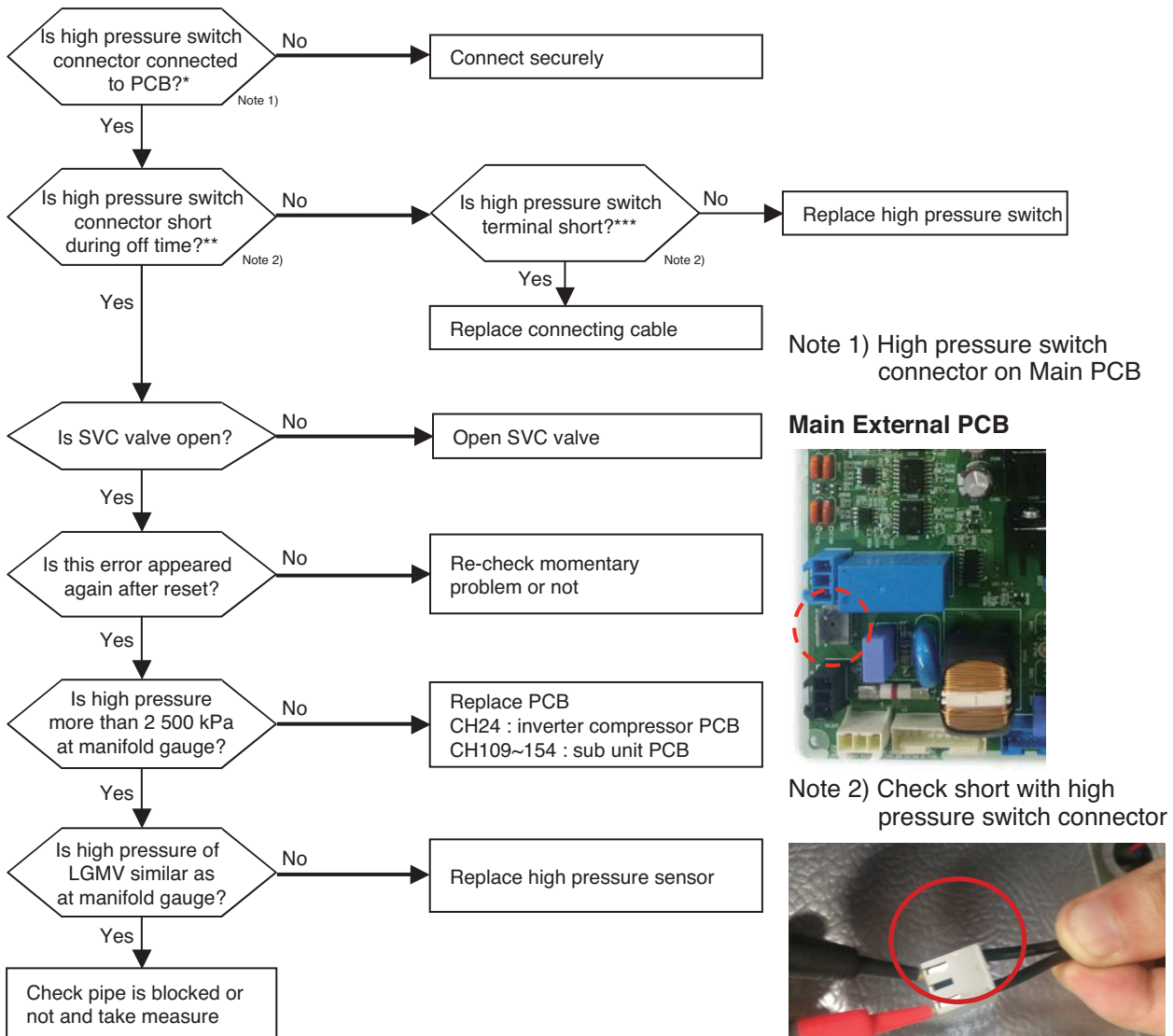

Error code check

Error No.	Error Type	Error Point	Main Reasons
25 (251)	Input Voltage high/low	Input voltage is over limited value of the product (304 V or less, 536 V or more)	1. Input voltage abnormal (R-S-T) 2. Outdoor unit inverter PCB assembly damage (input voltage sensing part)

■ **Error Diagnosis and Countermeasure Flow Chart**

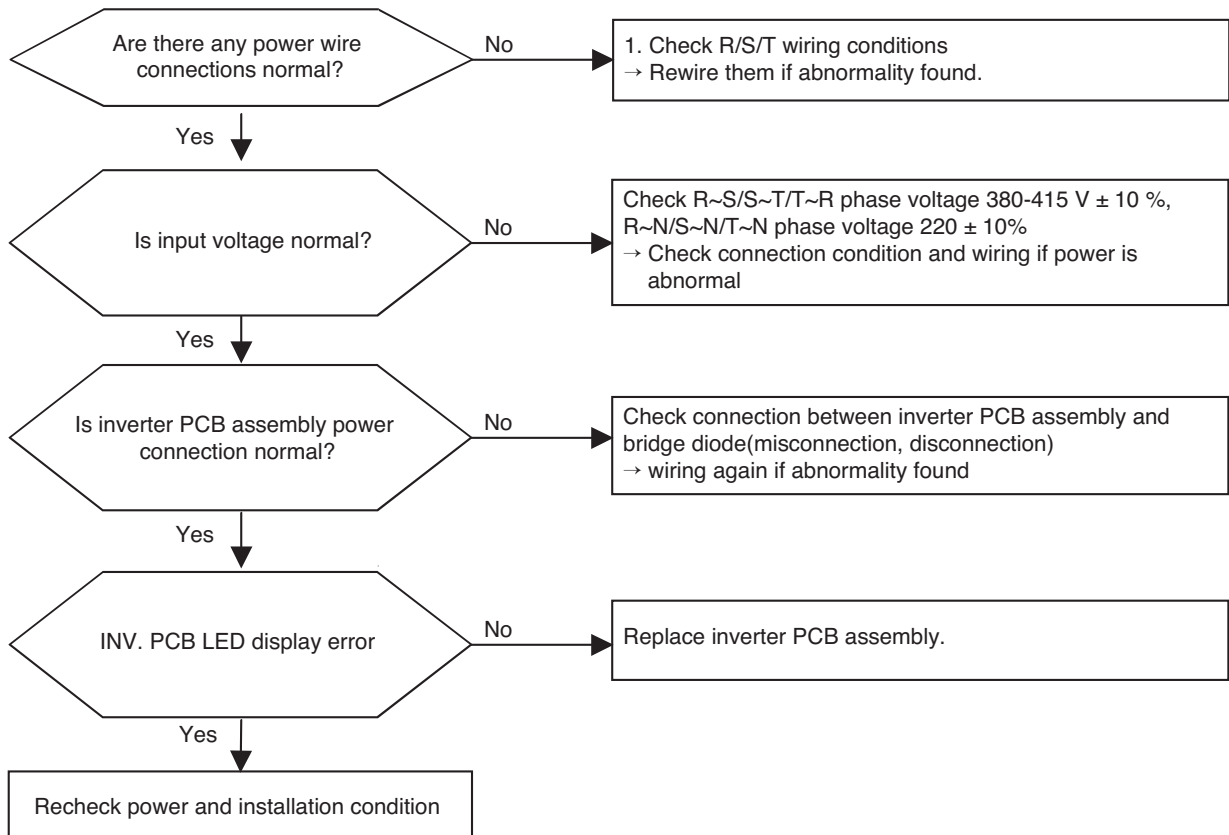

Error No.	Error Type	Error Point	Main Reasons
26 (261)	Inverter compressor starting failure Error	Starting failure because of compressor abnormality	<ol style="list-style-type: none"> 1. Overload operation (Pipe clogging/Covering/EEV defect/Ref. overcharge) 2. Compressor damage (Insulation damage/Motor damage) 3. Compressor wiring fault 4. ODU inverter PCB damage (CT)

■ Error Diagnosis and Countermeasure Flow Chart

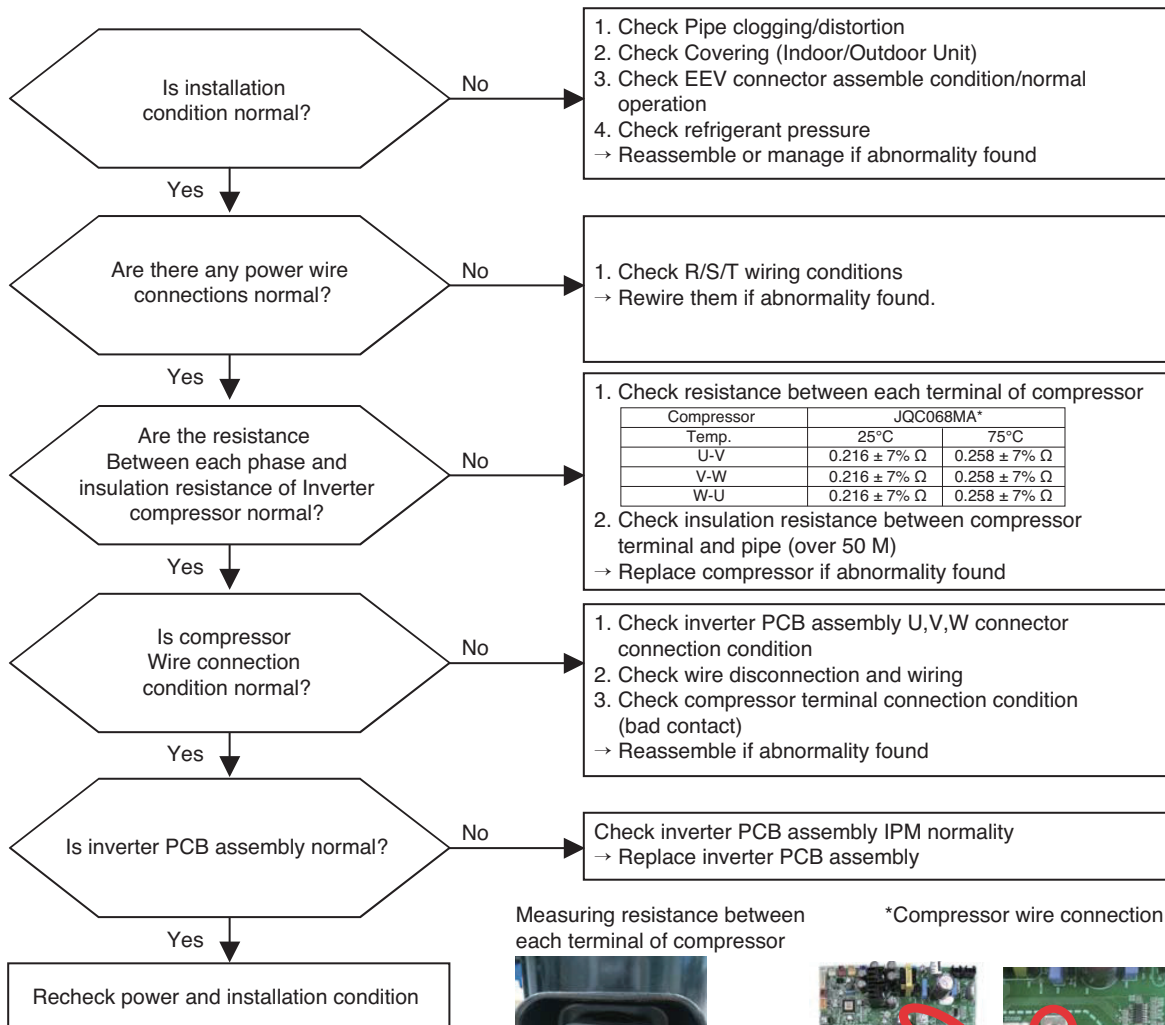

Compressor Temp.	JQC068MA*	
	25°C	75°C
U-V	0.216 ± 7% Ω	0.258 ± 7% Ω
V-W	0.216 ± 7% Ω	0.258 ± 7% Ω
W-U	0.216 ± 7% Ω	0.258 ± 7% Ω

Measuring resistance between each terminal of compressor



*Compressor wire connection

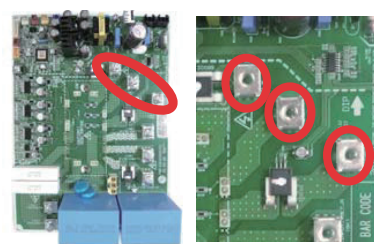

Error code check

Error No.	Error Type	Error Point	Main Reasons
29 (291)	Inverter compressor over current	Inverter compressor input current is over 30 A	<ol style="list-style-type: none"> 1. Overload operation (Pipe clogging/Covering/EEV defect/Ref. overcharge) 2. Compressor damage(Insulation damage/Motor damage) 3. Input voltage low 4. ODU inverter PCB assembly damage

■ Error Diagnosis and Countermeasure Flow Chart

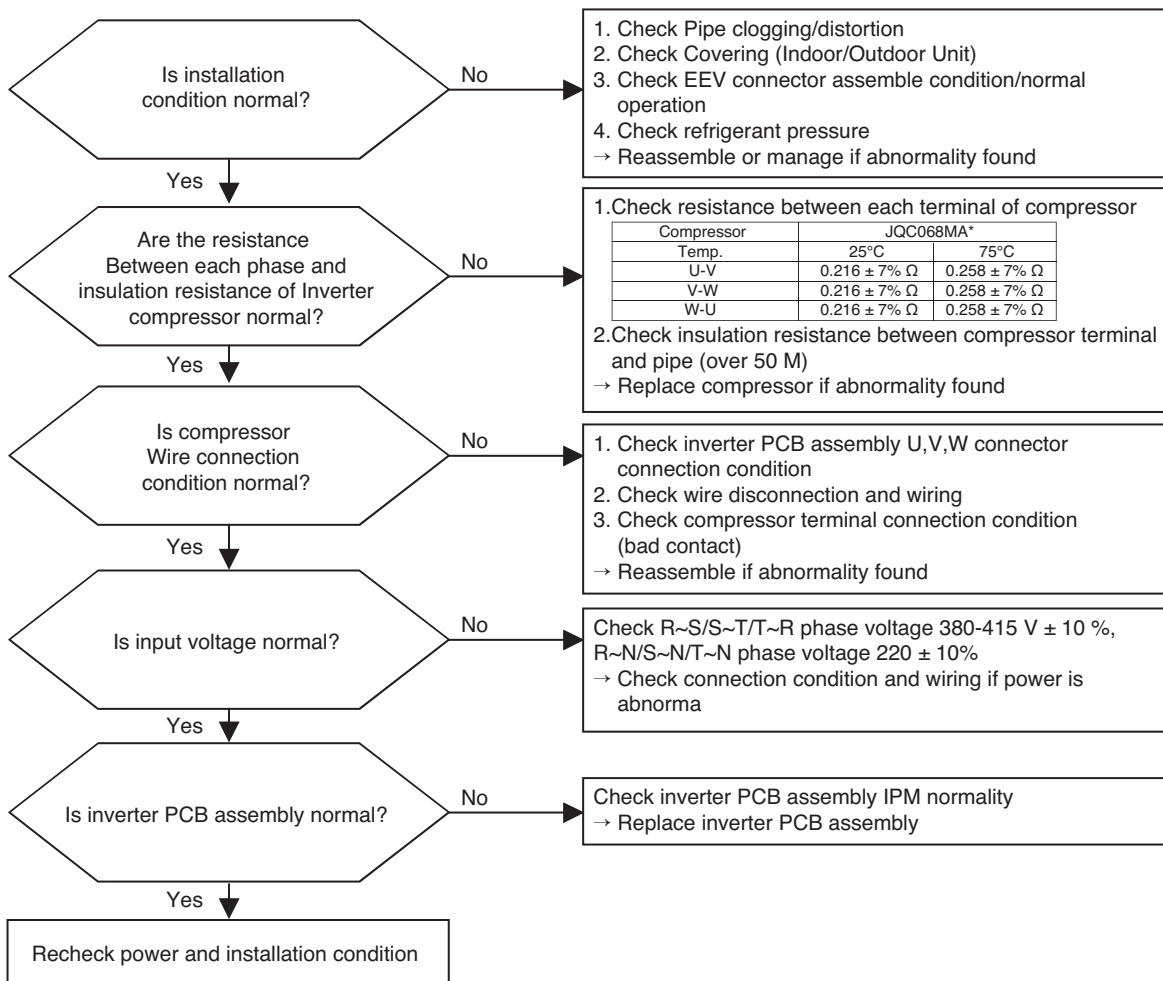

* Measuring resistance between each terminal of compressor



* Compressor wire connection



* Measuring input voltage

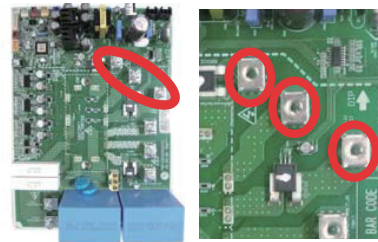

Error No.	Error Type	Error Point	Main Reasons
32 (321)	Inverter compressor 1, 2 discharge temperature excessive increase	Compressor off caused by an excessive increase of an Inverter compressor 1, 2 discharge temperature	1. Inverter compressor 1, 2 discharge pipe temperature sensor defect 2. Refrigerant shortage/ Leakage 3.EEV failure 4.Liquid spray valve failure

■ Failure diagnosis method

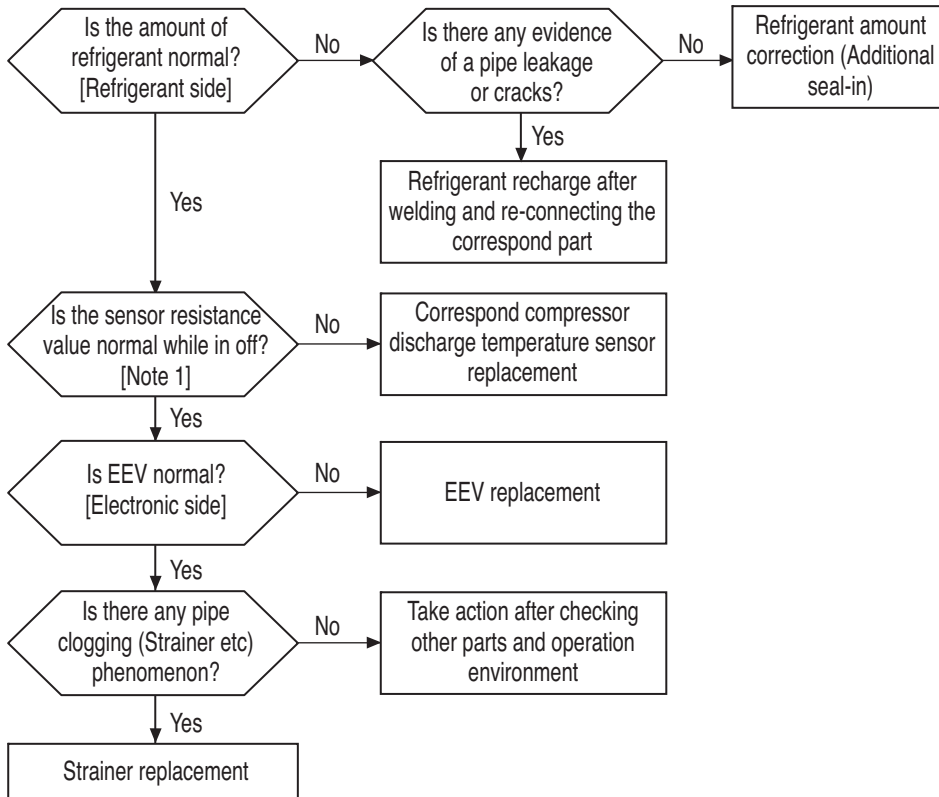

Error code check

Error No.	Error Type	Error Point	Main Reasons
34 (341)	Compressor discharge pressure excessive increase	Error caused by a continuous occurrence of compressor off (10 times) due to a high pressure increase	<ol style="list-style-type: none"> 1. High voltage sensor failure 2. Fan failure 3. Deformation caused by refrigerant pipe damage 4. Refrigerant over charge 5. EEV defect 6. When shielding 7. PCB defect 8. Temperature sensor defect 9. Hot gas valve defect

■ Failure diagnosis method

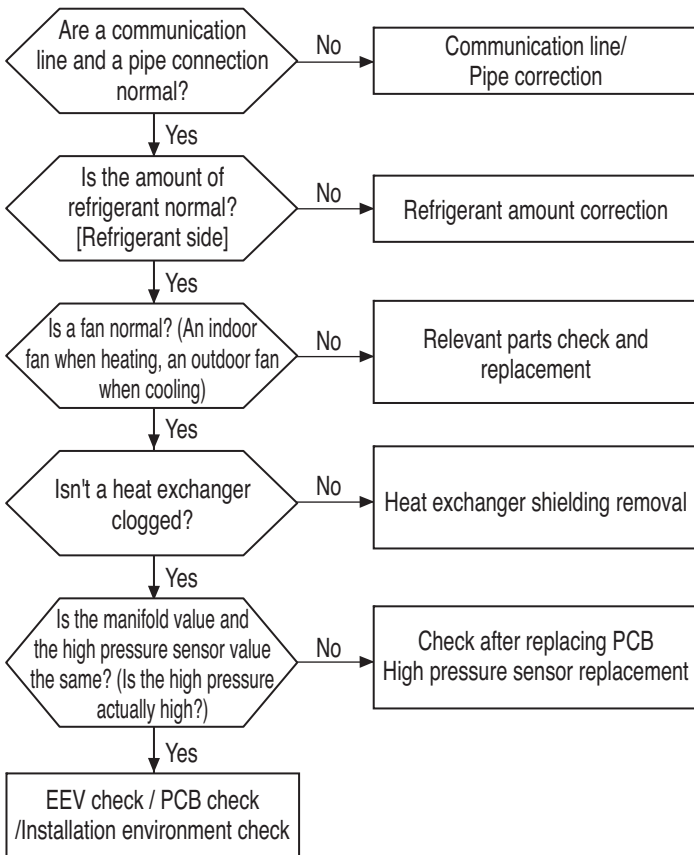

Error No.	Error Type	Error Point	Main Reasons
35 (351)	Excessive drop of discharge pressure of compressor	Error happens because of 3 times successive compressor off due to excessive drop of low pressure by the low pressure sensor	<ol style="list-style-type: none"> 1. Defective low pressure sensor 2. Defective outdoor/indoor unit fan 3. Refrigerant shortage/leakage 4. Deformation because of damage of refrigerant pipe 5. Defective indoor / outdoor unit EEV 6. Covering / clogging (outdoor unit covering during the cooling mode/ indoor unit filter clogging during heating mode) 7. SVC valve clogging 8. Defective outdoor unit PCB 9. Defective indoor unit pipe sensor

■ Failure diagnosis method

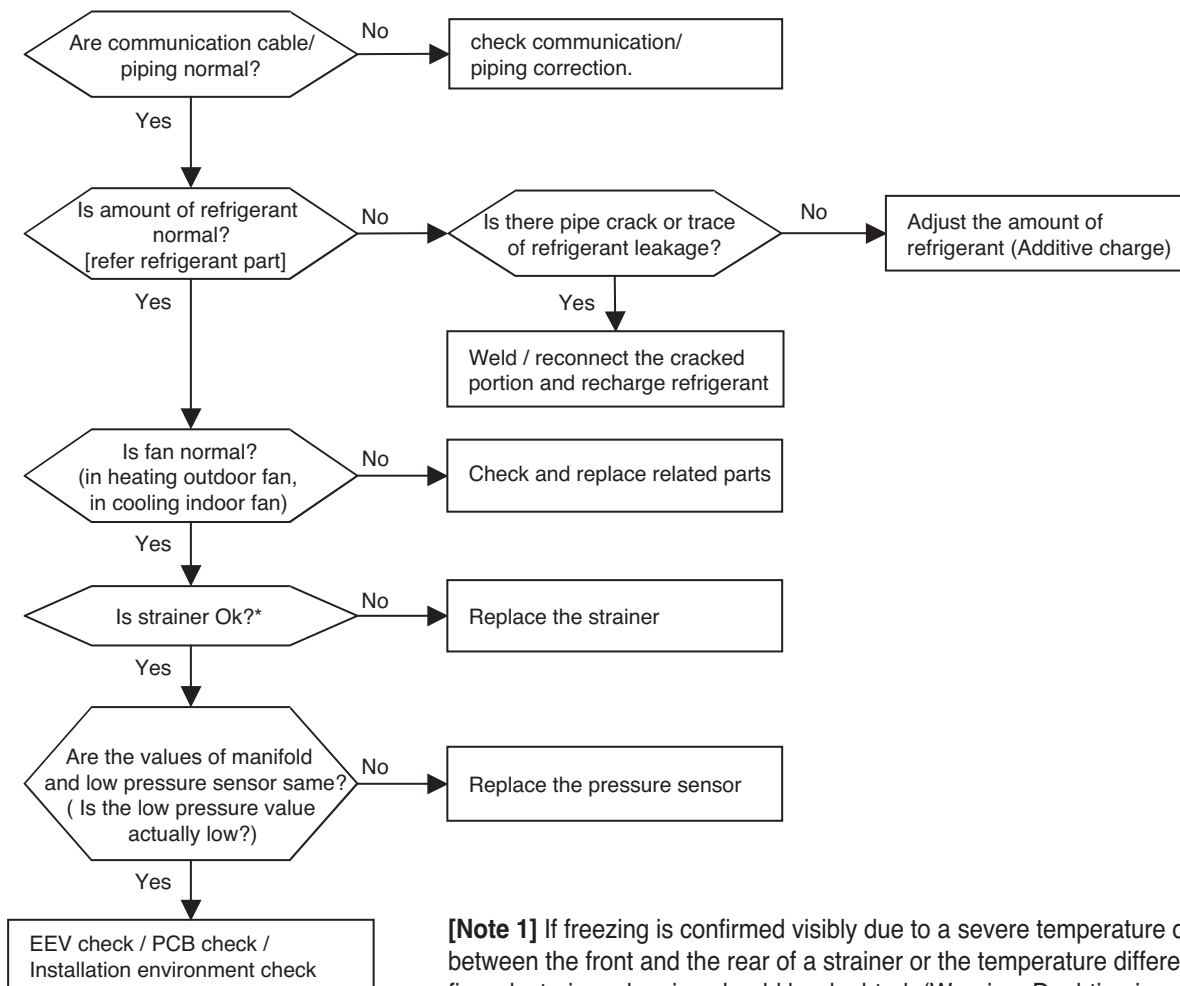

[Note 1] If freezing is confirmed visibly due to a severe temperature difference between the front and the rear of a strainer or the temperature difference is confirmed, strainer clogging should be doubted. (Warning: Doubting in case where freezing on the front of the strainer is removed and then the freezing is occurred all the sudden by passing around, not the whole freezing)

Error code check

Error No.	Error Type	Error Point	Main Reasons
40 (401)	Inverter compressor CT sensor error	Micom input voltage isn't within $2.5\text{ V} \pm 0.3\text{ V}$ at initial state of power supply	1. Input voltage abnormal (R-S-T) 2. ODU inverter PCB damage (CT sensing part)

■ Error Diagnosis and Countermeasure Flow Chart

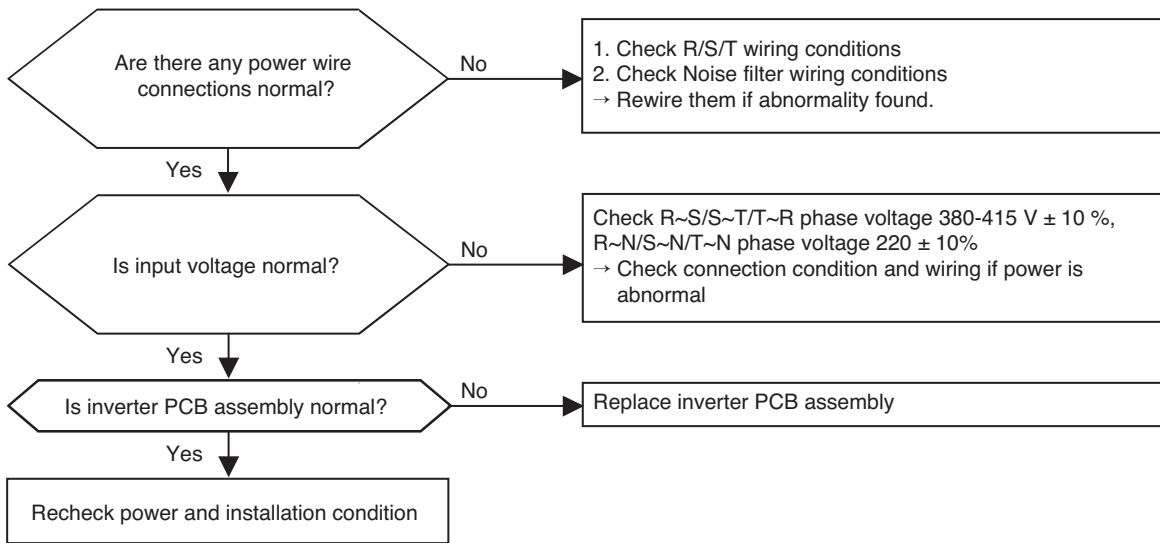

* Measuring input voltage



* Inverter PCB assembly



Error No.	Error Type	Error Point	Main cause of occurrence
41 (411)	Inverter compressor discharge pipe temperature sensor error	Resistance measurement value of a sensor is abnormal (Open/Short)	<ol style="list-style-type: none"> 1. Compressor discharge pipe temperature sensor connector connection defect 2. Compressor discharge pipe temperature sensor defect (Open/Short) 3. Outdoor unit PCB defect

■ Failure diagnosis method

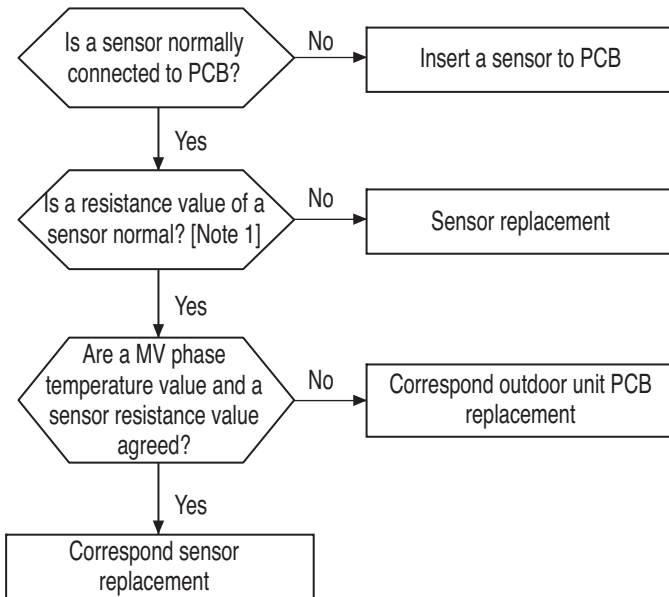

[Note 1] An error occurs in case of more than 5 MΩ (Open) or less than 2 kΩ (Short)

Reference: A discharge temperature sensor is normal if a resistance value changes depending upon the temperature and next resistance value is shown based on the current temperature (±5 % deviation)

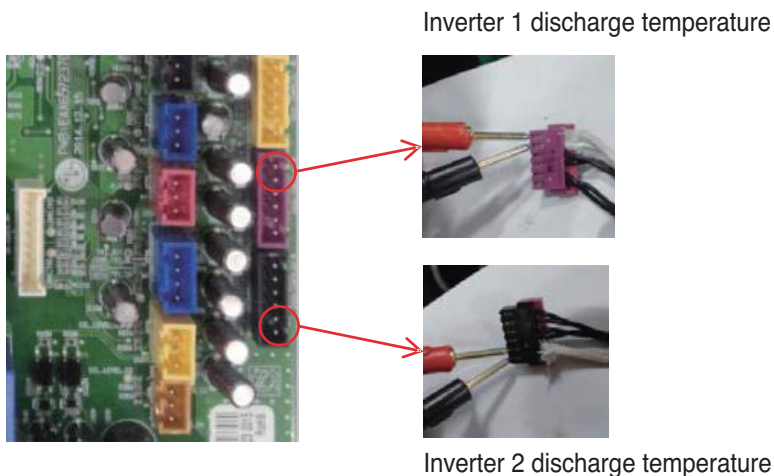

Error code check

Error No.	Error Type	Error Point	Main Reasons
42 (421)	Sensor error of low pressure	Abnormal value of sensor (Open/Short)	<ol style="list-style-type: none"> 1. Bad connection of low pressure connector 2. Defect of low pressure connector (Open/Short) 3. Defect of outdoor PCB
43 (431)	Sensor error of high pressure	Abnormal value of sensor (Open/Short)	<ol style="list-style-type: none"> 1. Bad connection of high pressure connector 2. Defect of high pressure connector (Open/Short) 3. Defect of outdoor PCB

■ Failure diagnosis method

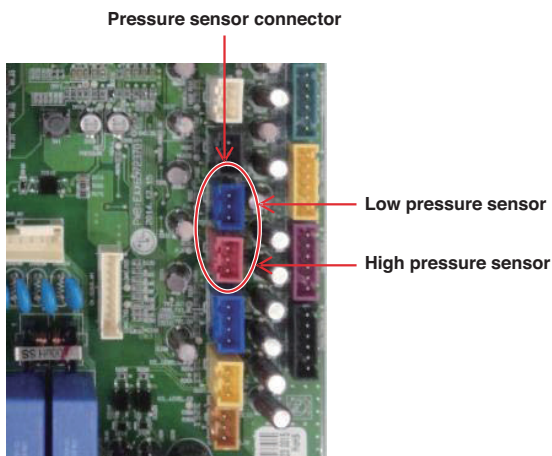
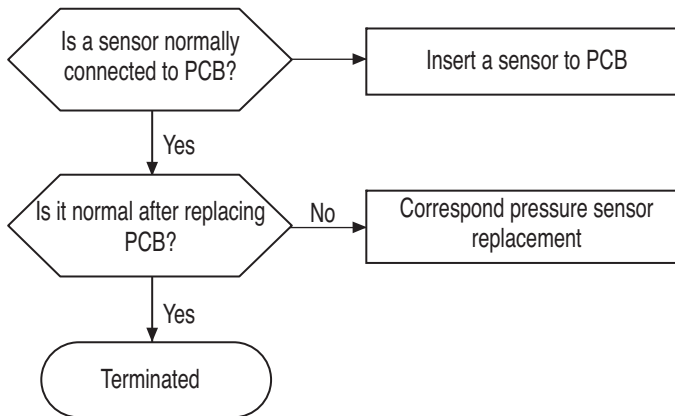

Error No.	Error Type	Error Point	Main Reasons
45 (451)	Heat exchanger pipe temperature sensor error	Resistance measurement value of a sensor is abnormal (Open/Short)	1. Temperature sensor connector connection defect 2. Temperature sensor defect (Open/Short) 3. PCB defect
46 (461)	Compressor suction temperature sensor error	Resistance measurement value of a sensor is abnormal (Open/Short)	1. Temperature sensor connector connection defect 2. Temperature sensor defect (Open/Short) 3. PCB defect

■ Failure diagnosis method

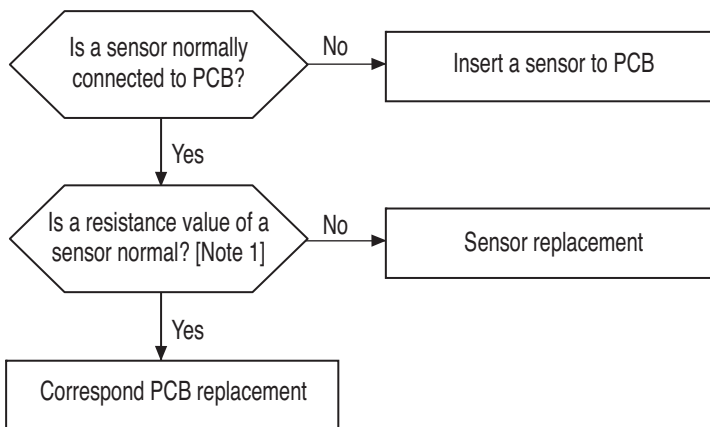

[Note 1] An error occurs in case of more than 100 kΩ (Open) or less than 100 Ω (Short)

Reference: A temperature sensor is normal if a resistance value changes depending upon the temperature and next resistance value is shown based on the current temperature (±5% deviation)

Air temperature sensor: 10 °C = 20.7 kΩ : 25 °C= 10 kΩ : 50 °C= 3.4 kΩ

Pipe temperature sensor: 10 °C = 10 kΩ : 25 °C= 5 kΩ : 50 °C= 1.8 kΩ

Error code check

Error No.	Error Type	Error Point	Main Reasons
50 (501)	ODU 3phase power omission error	Omitting one or more of R,S,T input power	<ol style="list-style-type: none"> 1. Input Voltage abnormal (R,S,T,N) 2. Check power Line connection condition 3. CYCLE Main PCB damage 4. Inverter PCB input current sensor fault

■ Error Diagnosis and Countermeasure Flow Chart

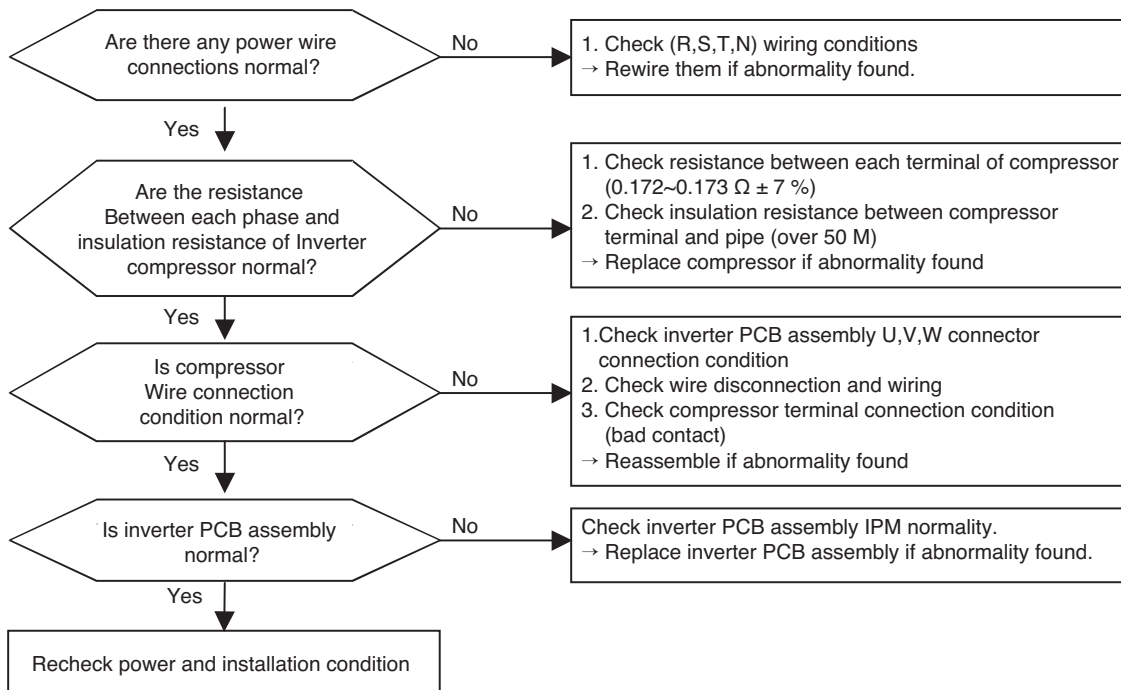

* Measuring input voltage



* Noise filter wiring

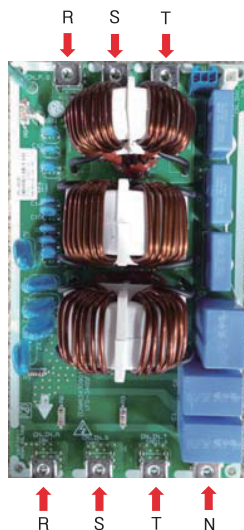

*Field Fault Case

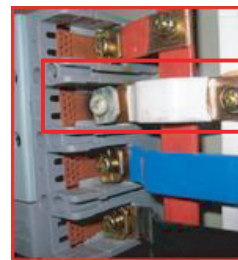

* R-Phase Terminal Changed Color.

Error No.	Error Type	Error Point	Main Reasons
52 (521)	Communication error between (Inverter PCB → CYCLE Main PCB)	Main controller of Master unit can't receive signal from inverter controller	1. Power cable or communication cable is not connected 2. Defect of outdoor Main fuse/Noise Filter 3. Defect of outdoor Main / inverter PCB

■ Error diagnosis and countermeasure flow chart

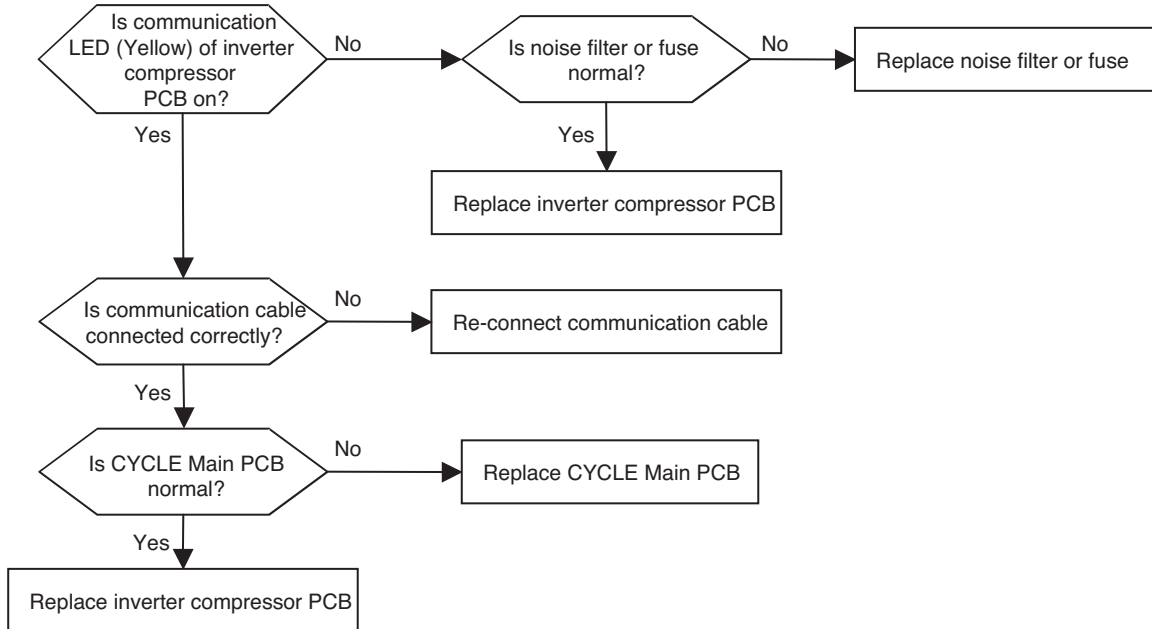

* The method of checking CYCLE Main PCB and inverter compressor PCB (If normal, communication LED blinks)

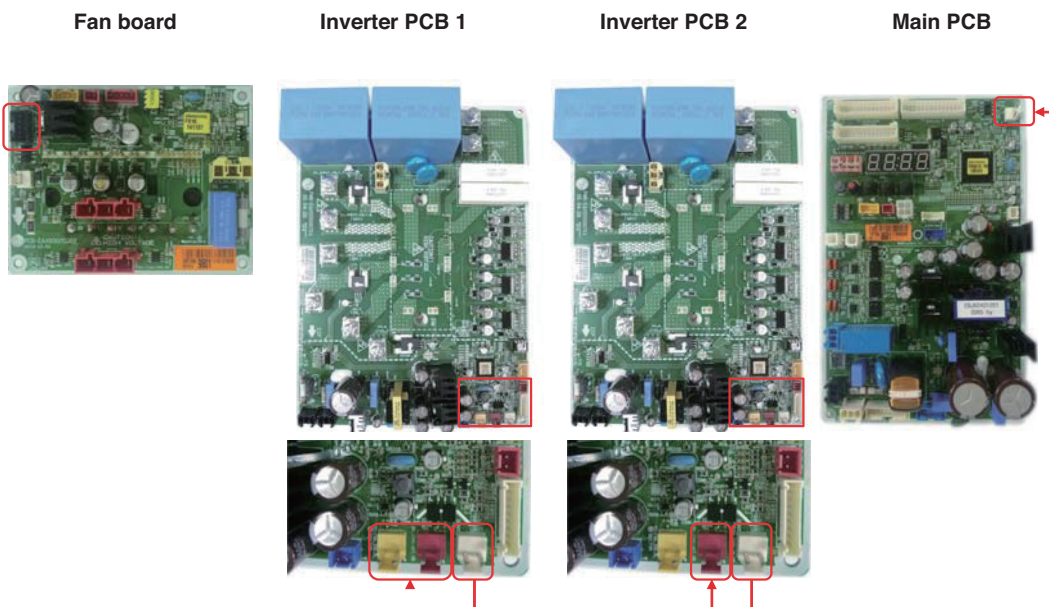

Error code check

Error No.	Error Type	Error Point	Main Reasons
53 (531)	Communication error (indoor unit → main board)	When the indoor unit signal is not received at the outdoor unit main board	<ol style="list-style-type: none"> 1. Communication cable is not connected 2. Disconnection or short circuit of the communication line 3. Outdoor unit main / indoor unit PCB defect 4. Middle connection to communication line is used (welding is not performed)

■ How to diagnose the disorder

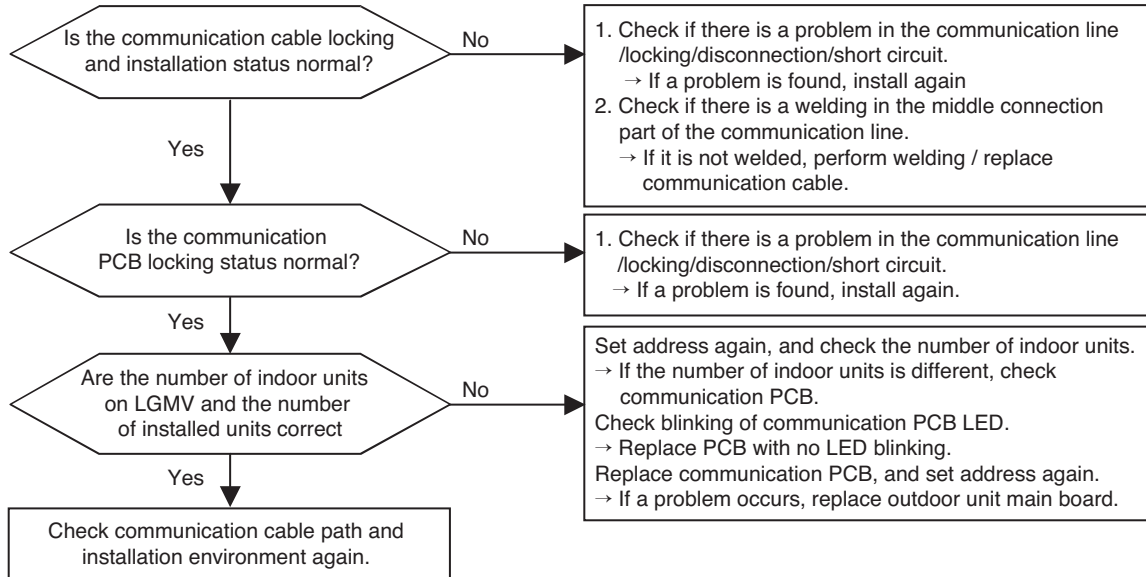

Indoor/outdoor unit communication part

External PCB



Main PCB



Cases of field defects



Error No.	Error Type	Error Point	Main Reasons
57 (571)	Communication error : CYCLE Main PCB ↔ Inverter PCB	Failing to receive inverter signal at main PCB of Outdoor Unit	1. Bad Connection Between Inv and Main 2. Communication Wire Noise Effect 3. CYCLE Main PCB Damage 4. Inv PCB Damage

■ Failure diagnosis method

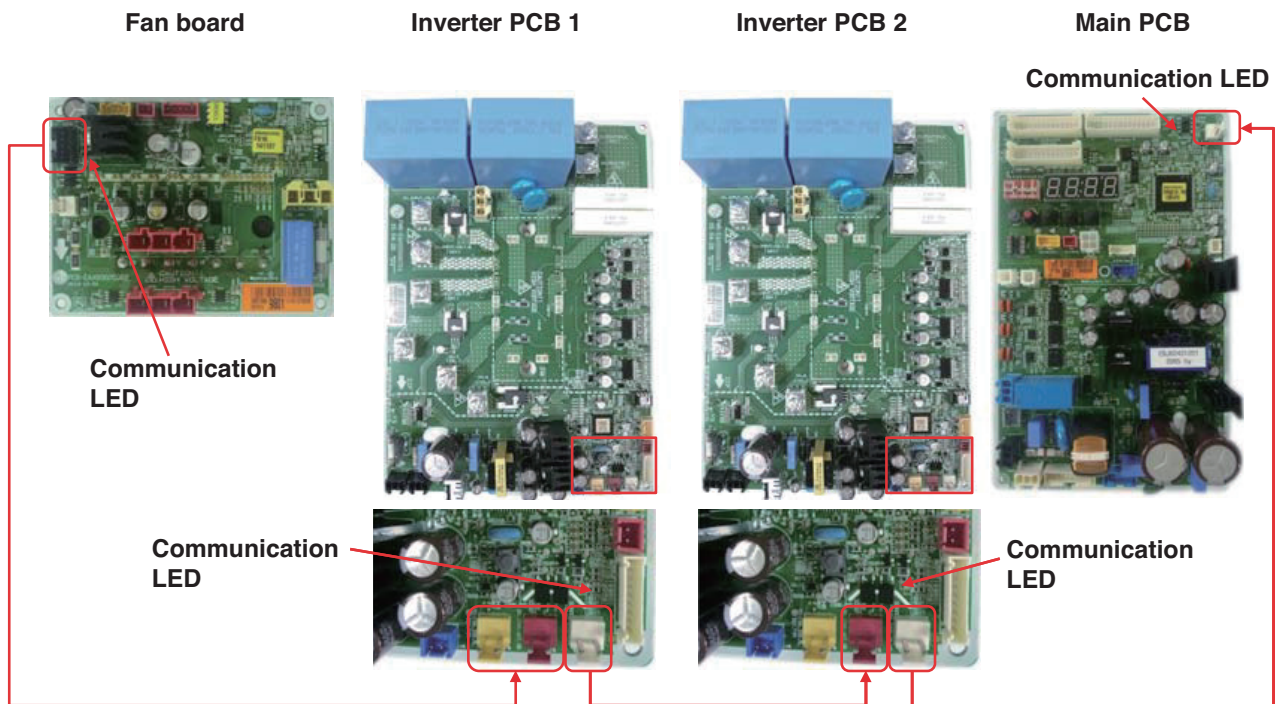
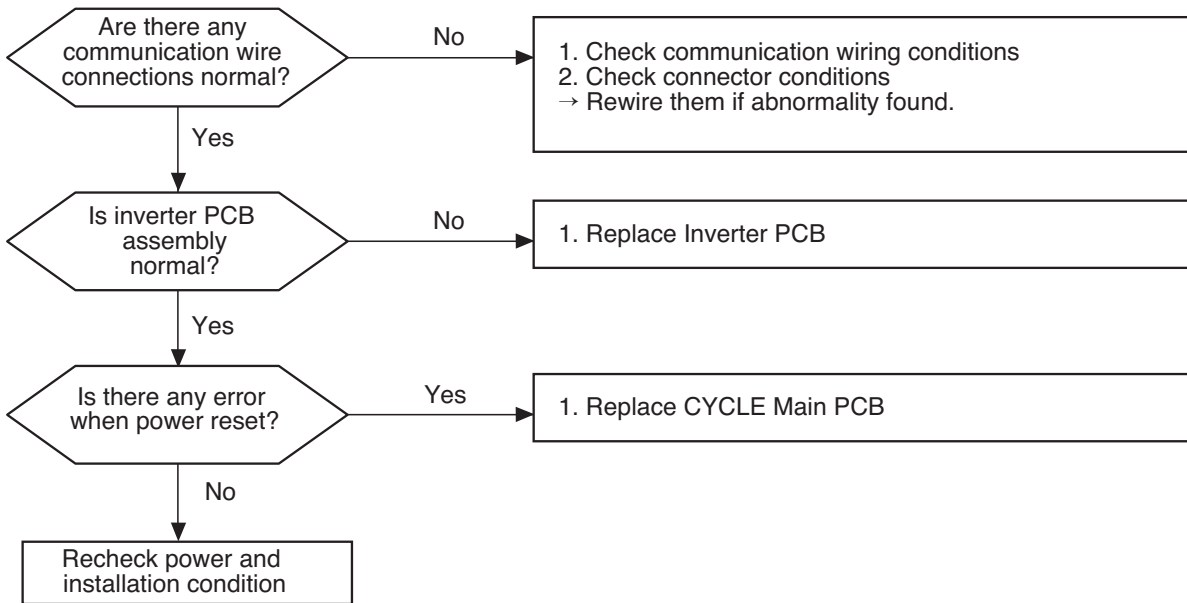

※ In case where a wire connector terminal has a contact defect and is inserted incompletely, be sure to turn off the outdoor unit power circuit breaker and then reset the power when confirming.

Error code check

Error No.	Error Type	Error Point	Main Reasons
60 (601)	Inverter PCB EEPROM error	EEPROM Access error and Check SUM error	1. EEPROM contact defect/wrong insertion 2. Different EEPROM Version 3. ODU inverter PCB assembly damage

■ Error Diagnosis and Countermeasure Flow Chart

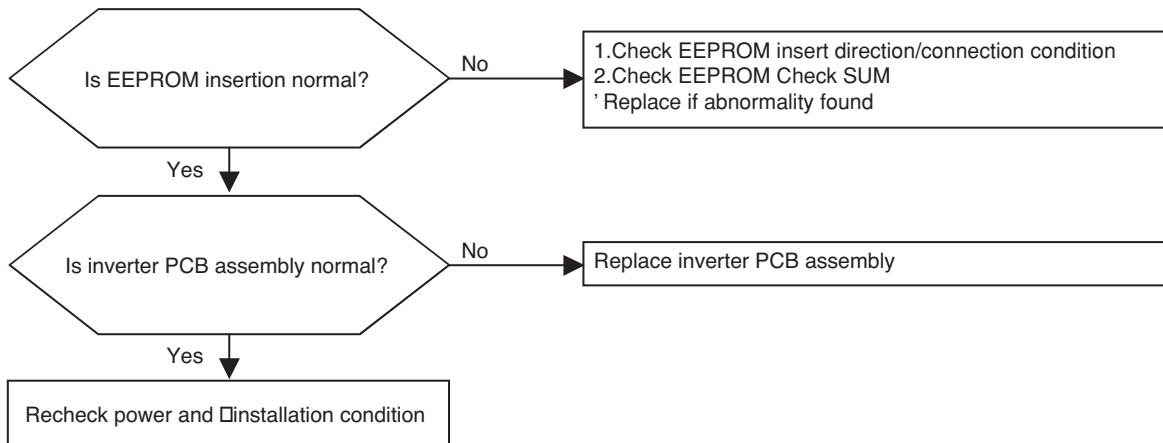

* Inverter EEPROM inserting point

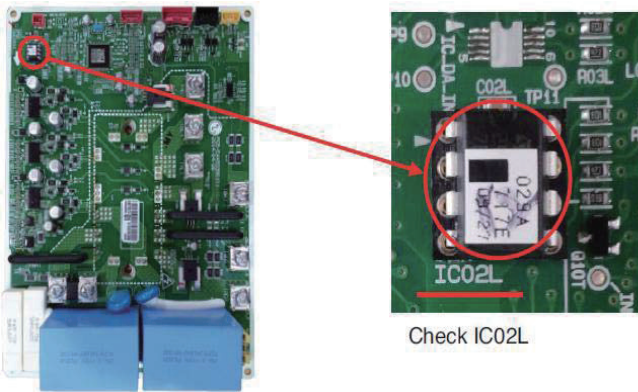

* Right inserting direction of inverter EEPROM

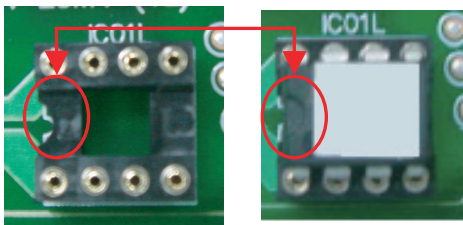

* Note : Replace after power off

Error No.	Error Type	Error Point	Main Reasons
62	Excessive temperature rise at the inverter board heat radiation plate	If the temperature detected at the heat radiation plate is 90 °C or higher	1. Cooling fan locking status defect 2. Inverter board power module locking status defect 3. Outdoor unit plate motor abnormal operation 4. Outdoor unit inverter board defect 5. Overload operation

■ How to diagnose the disorder

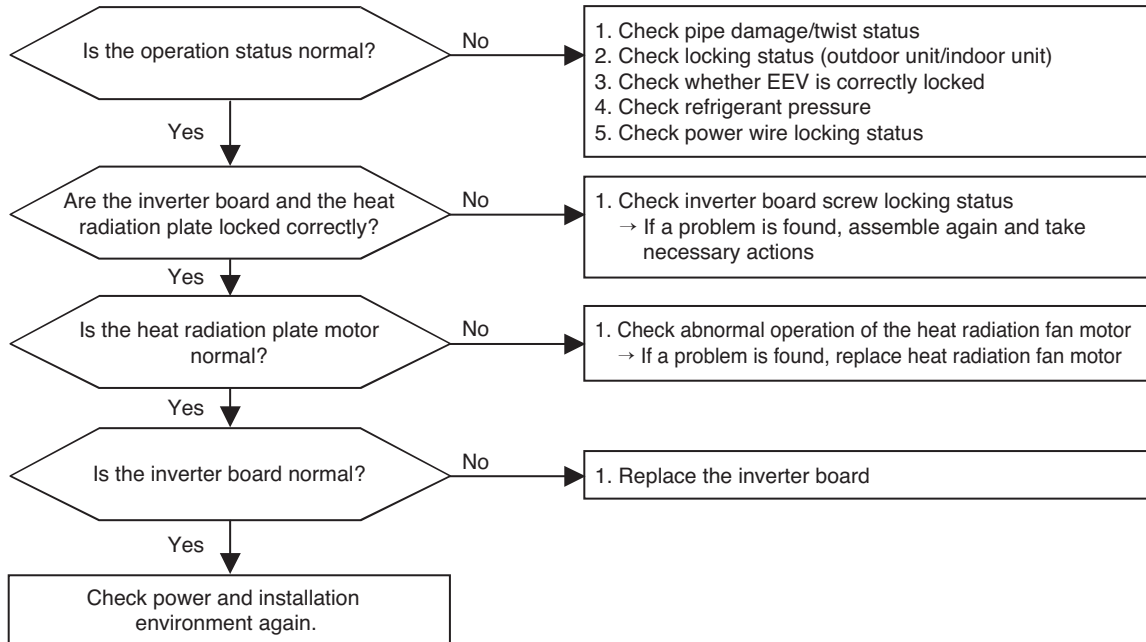

Check the inverter board and heat radiation plate locking status

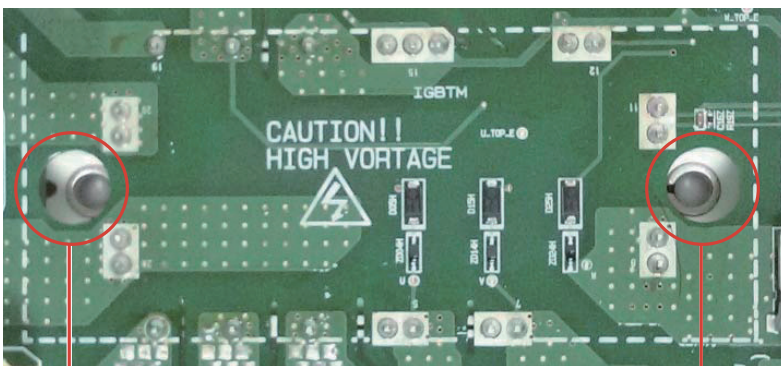

※ Check screw connection condition

Error code check

Error No.	Error Type	Error Point	Main Reasons
65	Inverter power modul sensor error	Abnormal sensor resistance value (Open/Short)	1. Bad connection of low pressure connector 2. Defect of low pressure connector (Open/Short) 3. Defect of outdoor PCB

■ Failure diagnosis method

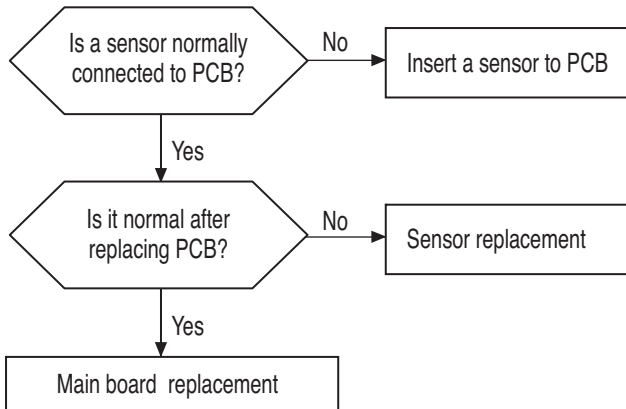

Error No.	Error Type	Error Point	Main Reasons
67 (671)	Fan Lock Error	Fan RPM is 10 RPM or less for 5 seconds when ODU fan starts or 40 RPM or less after fan starting.	1. Fan motor defect / assembly condition abnormal 2. Wrong connection of fan motor connector 3. Reversing rotation after RPM target apply 4. Fan PCB assembly defect 5. Fan lock by Heavy Snowfall.

■ Failure diagnosis method

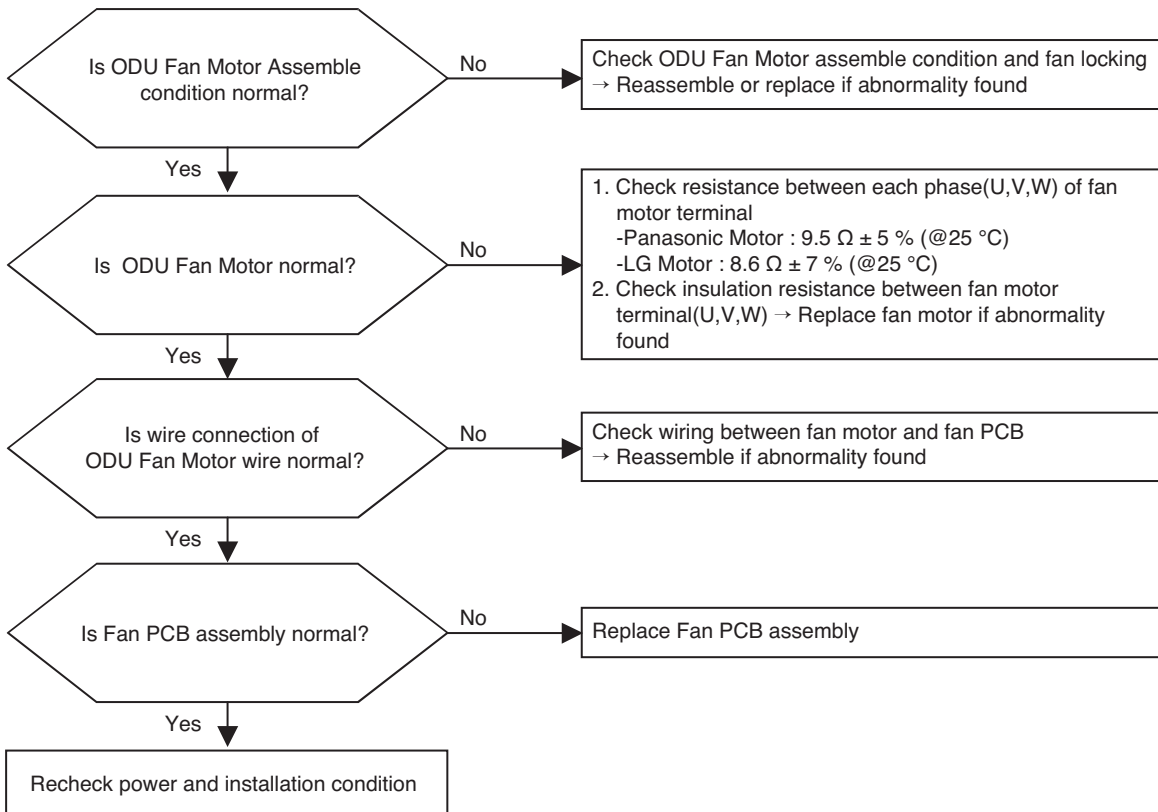

* Fan Motor resistance measuring between each phase



* Fan Motor Wire connection



Error code check

Error No.	Error Type	Error Point	Main Reasons
75 (751)	Fan CT sensor defect	In case where micom input voltage of the top current at the fan motor is out of 2.5 V \pm 0.3 V range	<ol style="list-style-type: none"> 1. Input voltage 15 V abnormality 2. Power wire disconnection and connector contact defect 3. Fan board defect [CT sensor detection part] 4. Inverter board defect [DC power part]

■ Failure diagnosis method

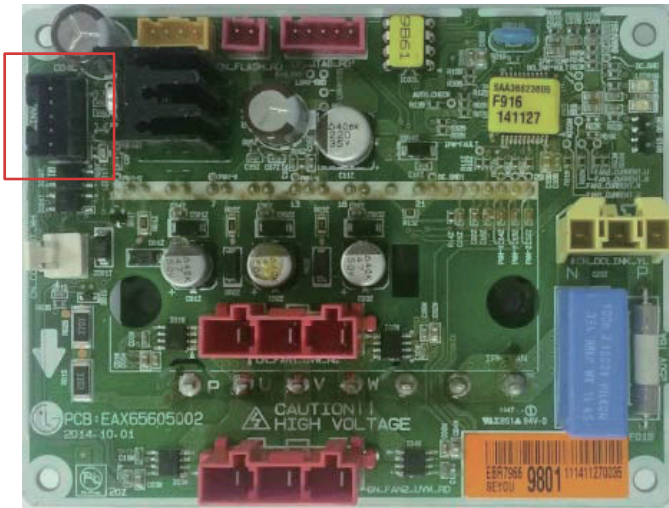
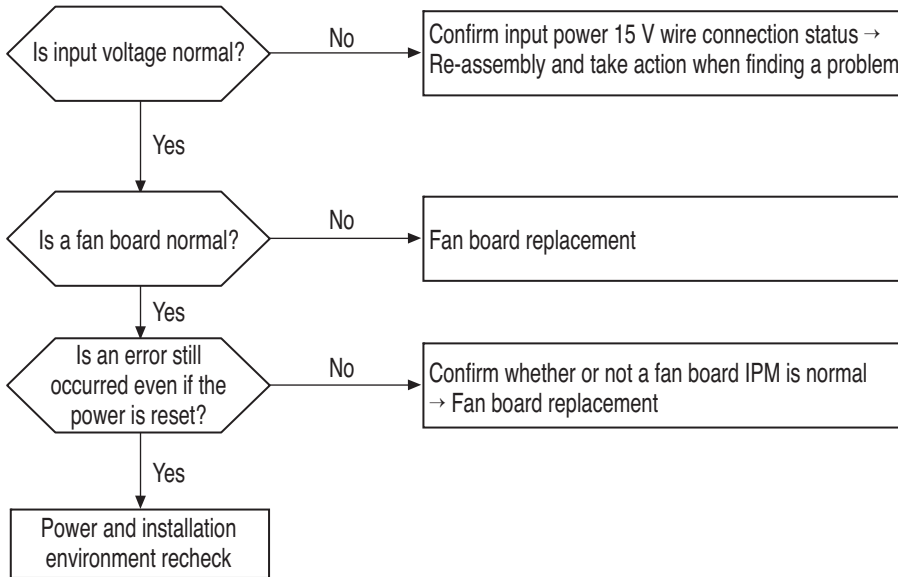

Check DC input power 15V on Inverter PCB.

Error No.	Error Type	Error Point	Main Reasons
77 (771)	Fan over voltage error	In case where output current is flow more than 5A	<ol style="list-style-type: none"> 1. Overload operation 2. Fan motor defect 3. Fan board defect 4. Fan motor connector insertion defect 5. Heat exchanger freezing or perfect shielding

■ Failure diagnosis method

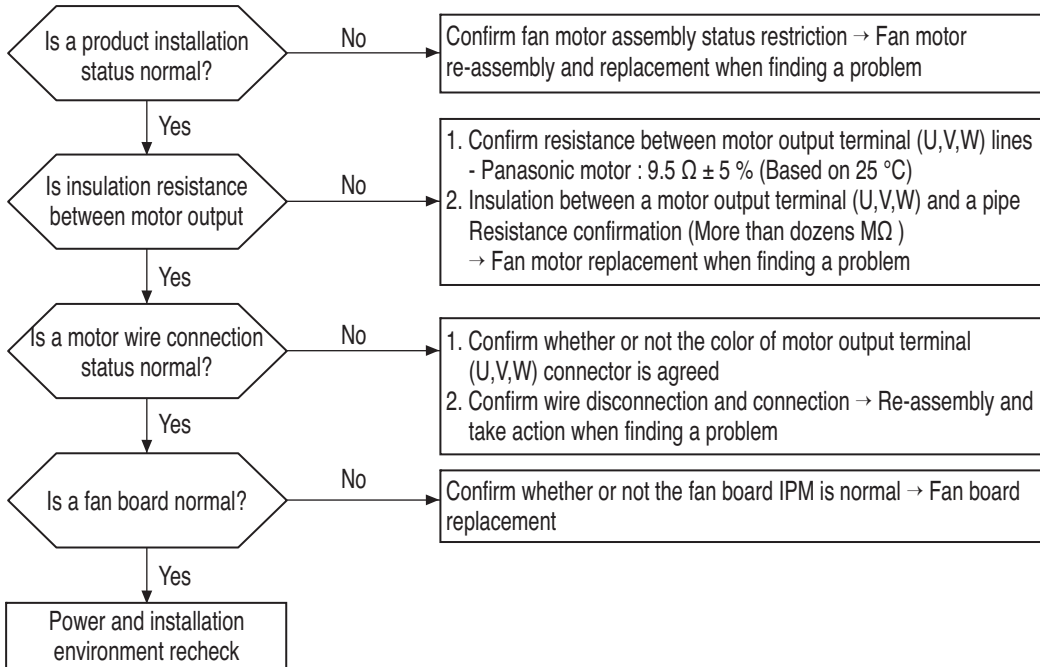

Resistance measurement method between fan motor lines

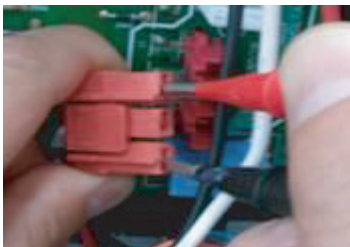

Fan motor wire connection part

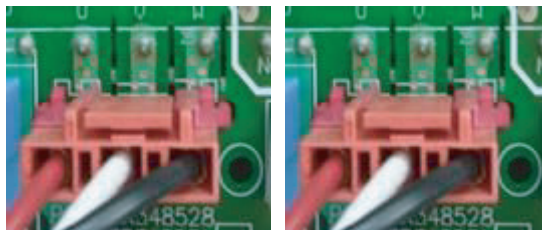

Error code check

Error No.	Error Type	Error Point	Main Reasons
79 (791)	Fan Starting Failure Error	Fan Motor initial starting failure	1. Fan motor defect/ assemble condition abnormal 2. Fan motor connector misconnection (Hall sensor, U,V,W output) 3. Fan PCB defect

■ Error Diagnosis and Countermeasure Flow Chart

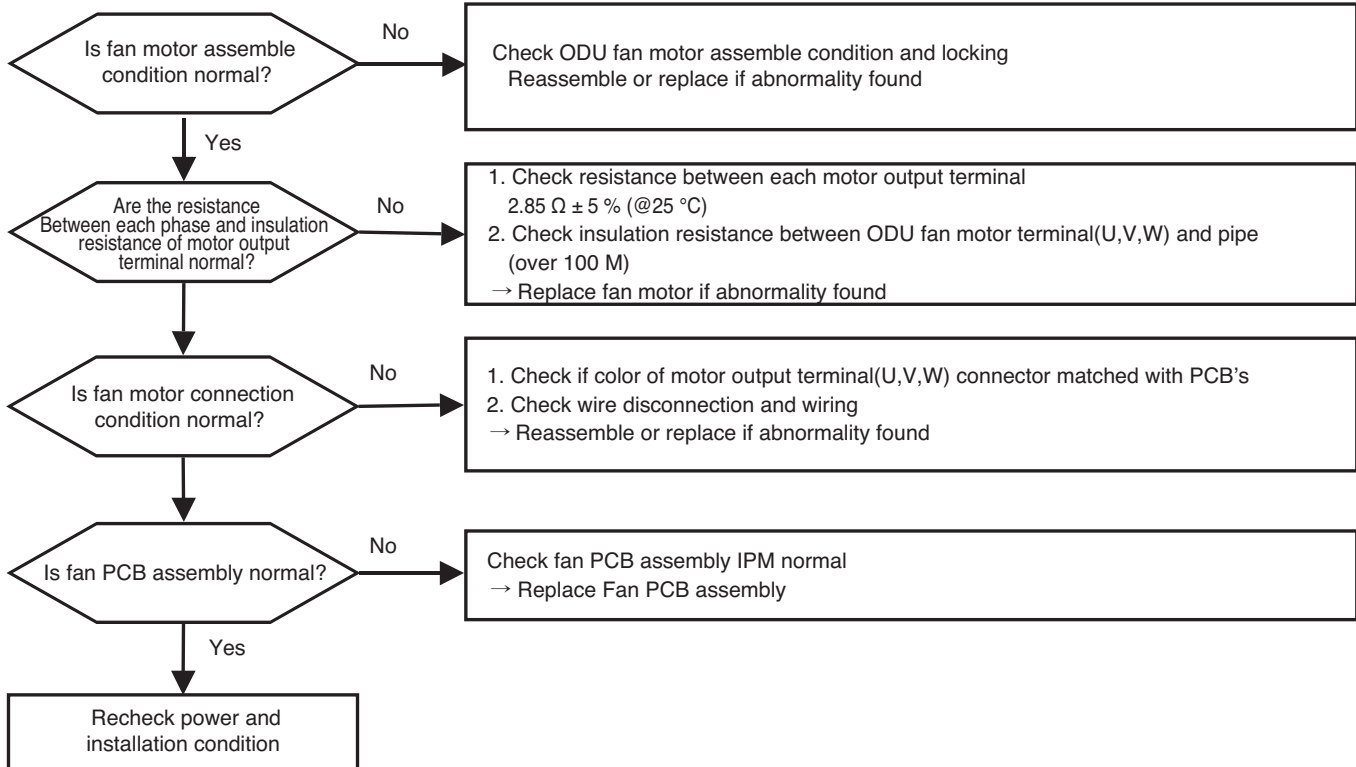

Measuring fan motor phase resistance



Measuring insulation resistance between fan terminal & chassis

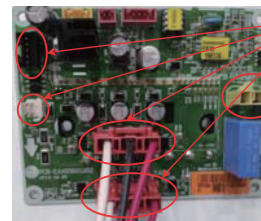

Check Point

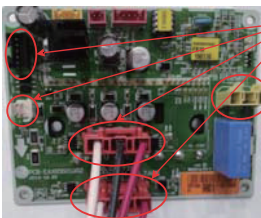

Check the connetion condition

Error No.	Error Type	Error Point	Main Reasons
86 (861)	CYCLE Main PCB EEPROM Error	EEPROM Access Error	1. No EEPROM 2. EEPROM wrong insertion

■ Failure diagnosis method

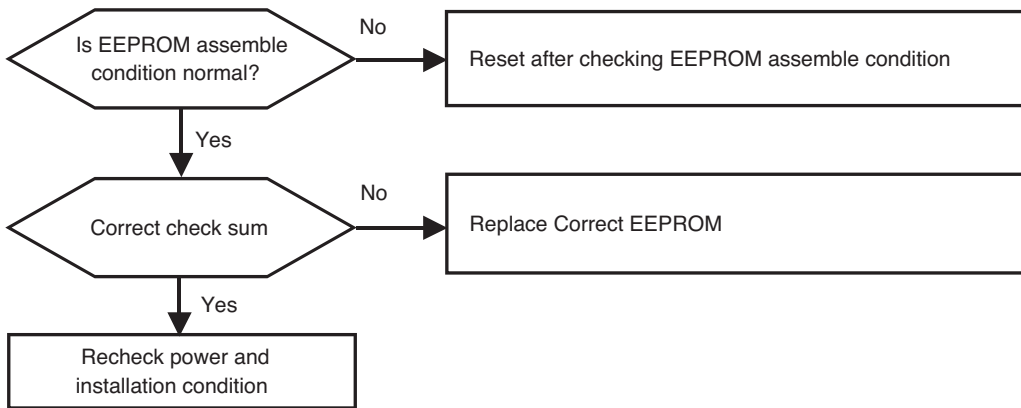

EEPROM Insertion

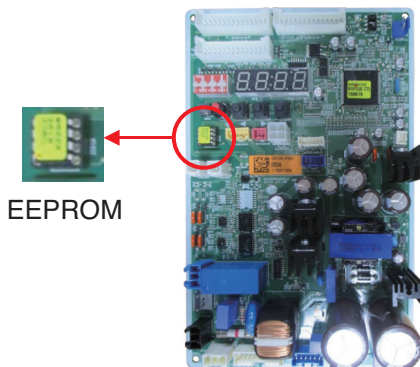

* Note : Replace after power off



Error code check

Error No.	Error Type	Error Point	Main Reasons
87 (871)	Fan PCB EEPROM Error	Error occurs when checking the EEPROM checksum as initializing after power is supplied	1. EEPROM bad contact/wrong insertion 2. EEPROM Version is different 3. ODU fan PCB assembly damage

■ Error Diagnosis and Countermeasure Flow Chart

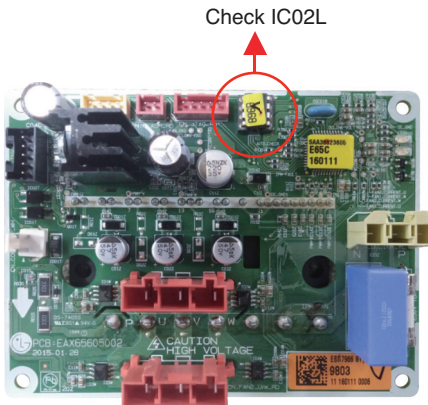
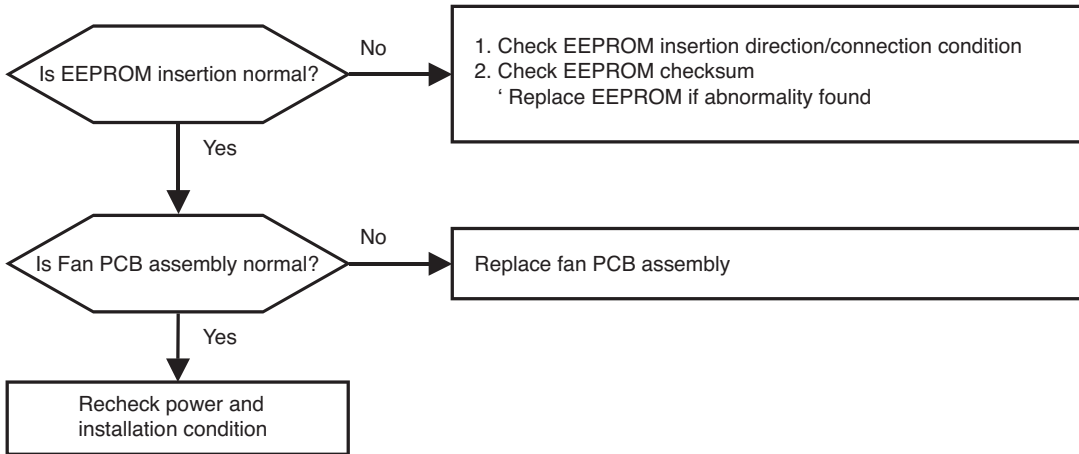

Inverter EEPROM insertion direction

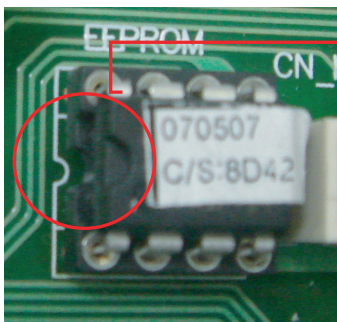

Same direction both socket hole and EEPROM hole

* Note : Replace after power off

Error No.	Error Type	Error Point	Main Reasons
105 (11 → 051)	Communication error (Fan PCB ↔ Inverter PCB)	Fan controller didn't receive signal from inverter controller	1. Wrong connection between Inverter and Fan PCB 2. Fan PCB power not supplied 3. Inv/Fan PCB defect

■ Failure diagnosis method

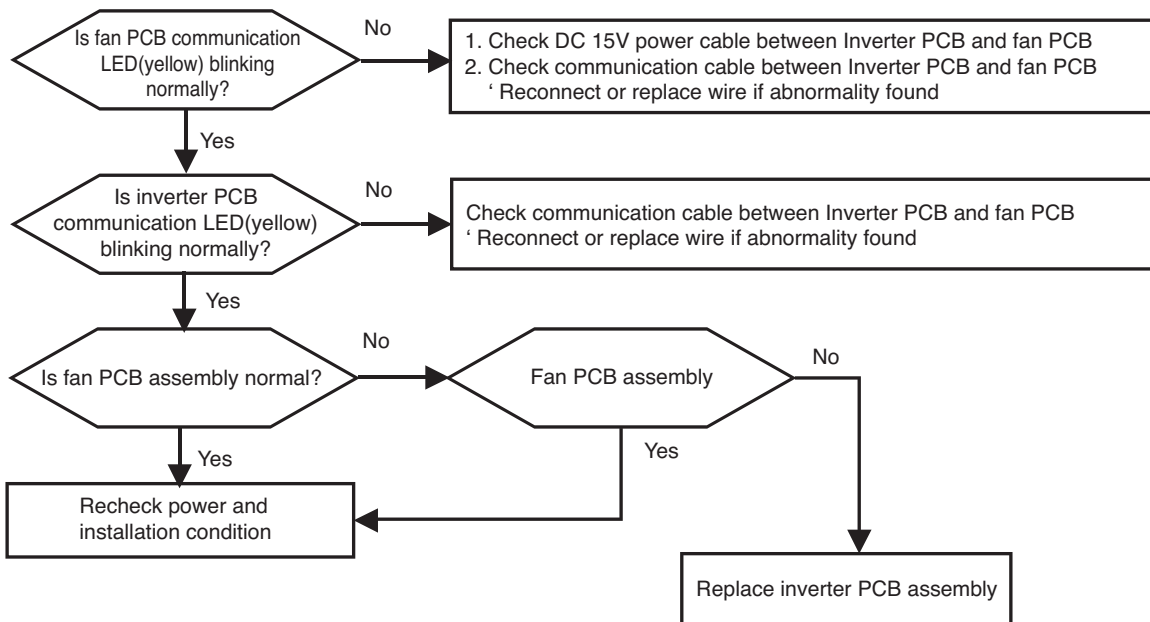

Comp ↔ Fan Communication Connection

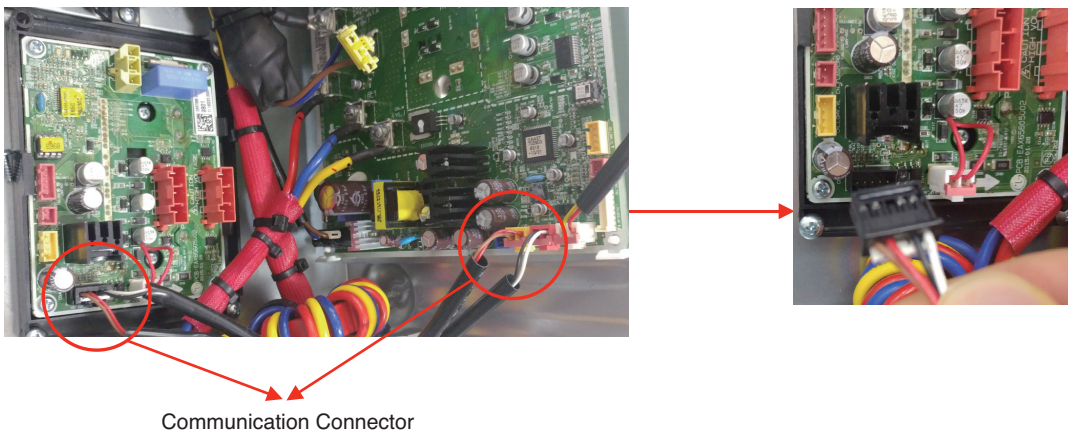

Error code check

Error No.	Error Type	Error Point	Main Reasons
106 (11 → 061)	Fan PCB IPM Fault	IPM protection circuit activation (over current / overheating)	<ol style="list-style-type: none"> 1. Overload operation (Pipe clogging/Covering/EEV defect/Ref. overcharge) 2. Fan motor assemble condition abnormal (Coil disconnection/Short/Insulation damage) 3. Fan PCB heatsink assemble condition abnormal 4. Fan PCB assembly defect

■ Failure diagnosis method

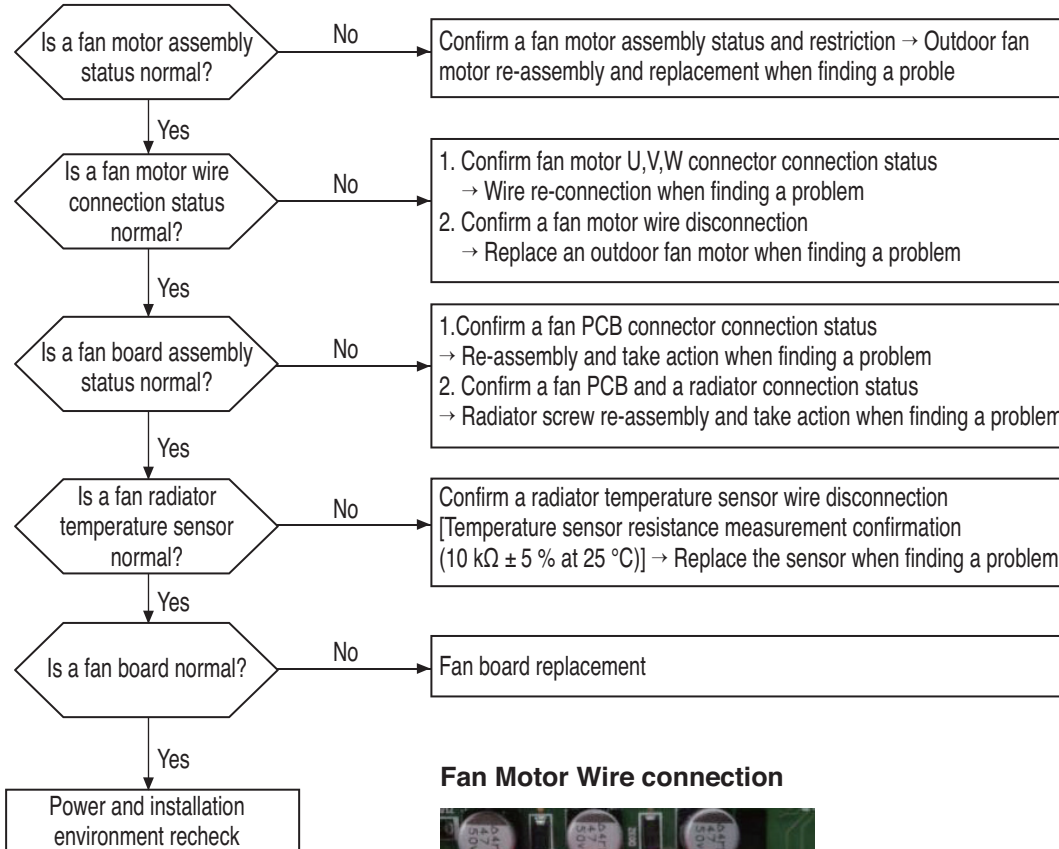

Fan Motor Wire connection

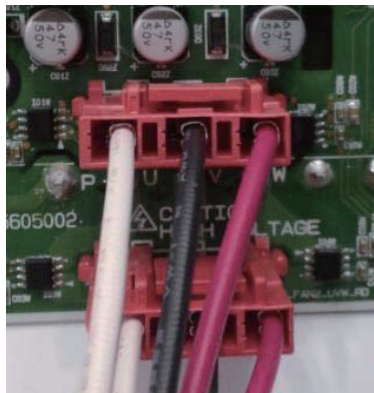

Error No.	Error Type	Error Point	Main Reasons
107 (11 → 071)	Fan DC Link low voltage error	In case where DC Link voltage of a fan board is permitted to less than 50 V	<ol style="list-style-type: none"> 1. Connection defect between an inverter board and a fan board 2. Fan board defect [DC Link detection part] 3. Reactor terminal contact defect 4. DC Link terminal misconnection/ Terminal contact defect (Loose) 5. 3 Phase bridge diode damage by a fire

■ Failure diagnosis method

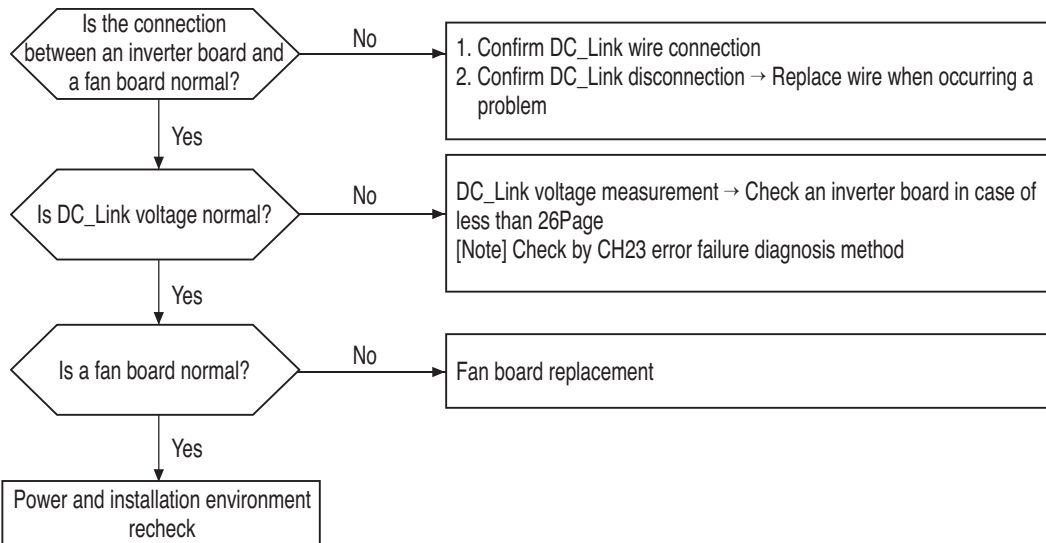

DC voltage connection

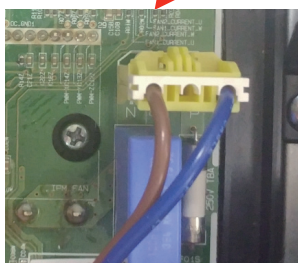
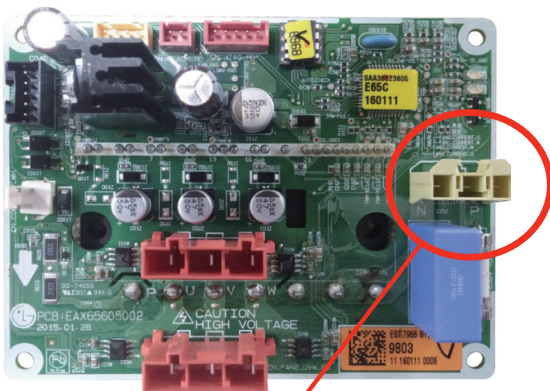

DC Volt connected

Error code check

Error No.	Error Type	Error Point	Main Reasons
113 (11 → 113)	Outdoor unit liquid pipe (condenser) temperature sensor error	Abnormal sensor resistance value (Open/Short)	1. Defective temperature sensor connection 2. Defective temperature sensor (Open / Short) 3. Defective outdoor unit PCB

Error No.	Error Type	Error Point	Main Reasons
114	Outdoor Unit Subcooling Inlet Temperature Sensor Error	Abnormal sensor resistance value (Open/Short)	1. Defective temperature sensor connector connection 2. Defective temperature sensor (Open / Short) 3. Defective outdoor PCB

Error No.	Error Type	Error Point	Main Reasons
115 (11 → 115)	Outdoor Unit Subcooling Outlet Temperature Sensor Error	Abnormal sensor resistance value (Open/Short)	1. Defective temperature sensor connector connection 2. Defective temperature sensor (Open / Short) 3. Defective outdoor PCB

■ Error diagnosis and countermeasure flow chart

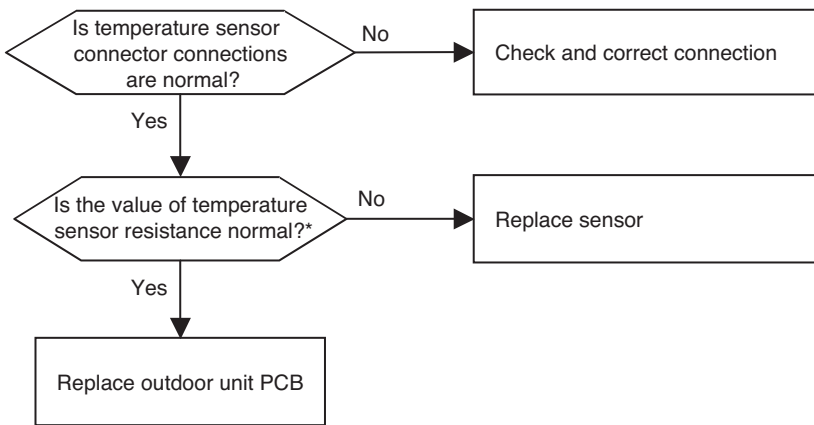

* Sensor resistance 100 kΩover (open) or 100 Ω below (short) will generate error

Note: Temperate sensor resistance vary with temperature, So compare temperature sensor resistance value according to outdoor unit temperature by referring below table (±5% tolerance)

Air temperature sensor: 10°C = 20.7kΩ : 25°C = 10kΩ : 50°C= 3.4kΩ

Pipe temperature sensor: 10°C = 10kΩ : 25°C = 5kΩ : 50°C= 1.8kΩ

Error No.	Error Type	Error Point	Main Reasons
145	Communication defect (main board, external board)	When external signal is not received at the main board due to the disorder of the external board	1. Power cable / Communication cable is not connected. 2. Outdoor unit main / external board defect

■ How to diagnose the disorder

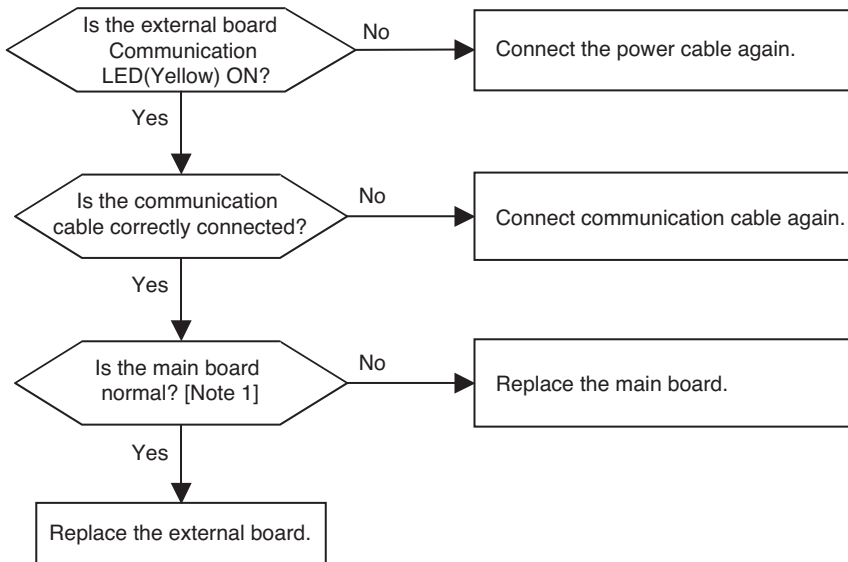

[Note 1] How to check the normal status of the main board and the external board (If it is normal, communication LED blinks.)

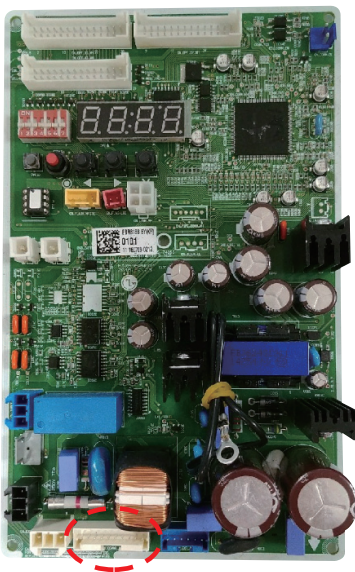

Main board communication LED and connector

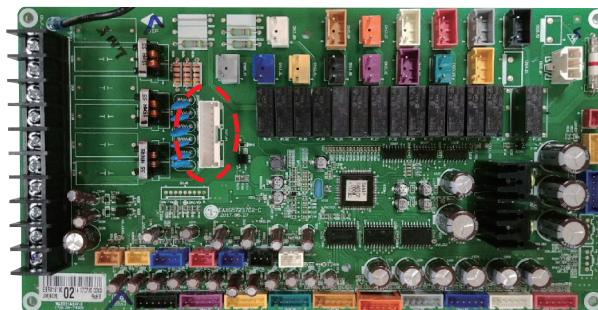

External board communication LED and connector

Error code check

Error No.	Error Type	Error Point	Main Reasons
151 (11 → 511)	Outdoor unit 4 way valve switching error	Outdoor unit 4 way valve switching failed	<ol style="list-style-type: none"> 1. 4way valve malfunction by entrance of foreign object 2. No high pressure/low pressure difference generated due to damage of the compressor 3. Incorrect installation of the common pipe between outdoor units 4. 4way valve unit defect

■ How to diagnose the disorder

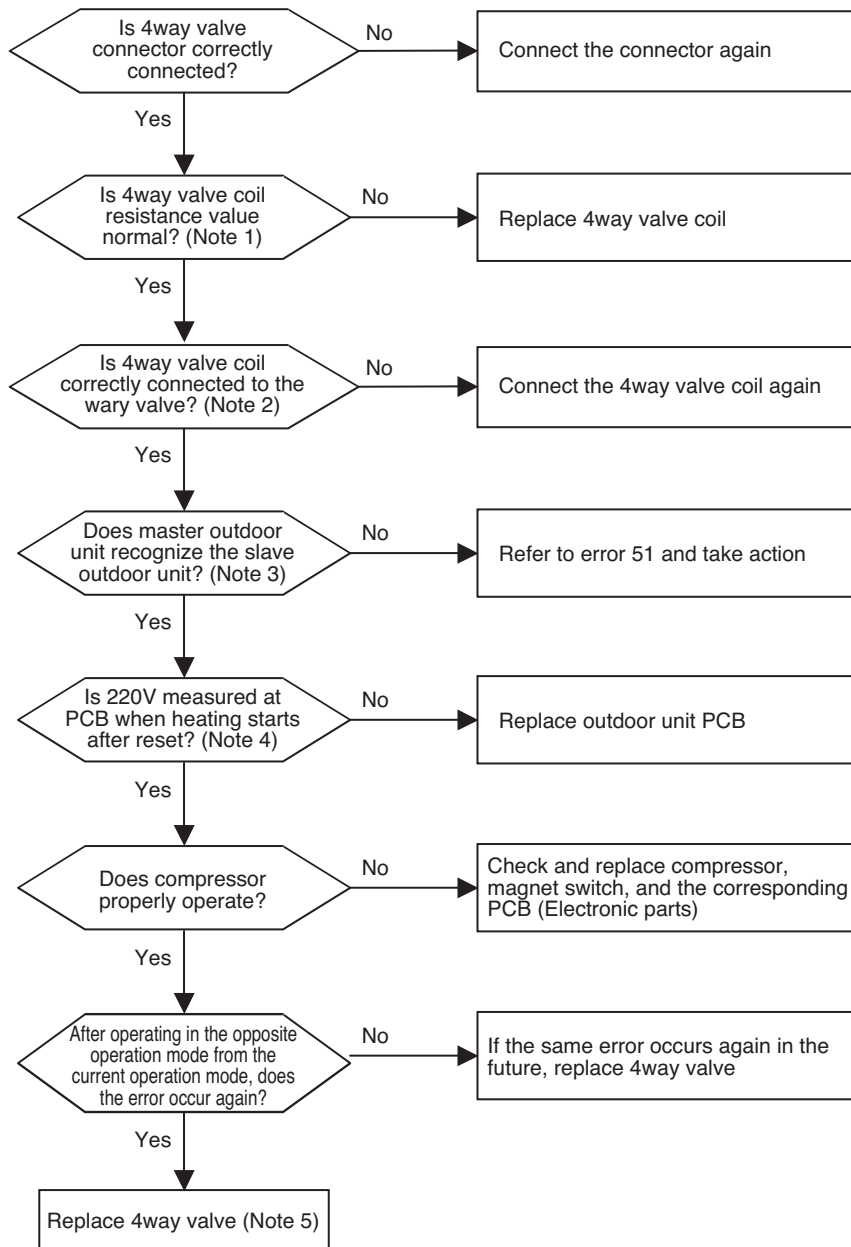

(Note 1) Measure resistance to see if 4way valve is normal

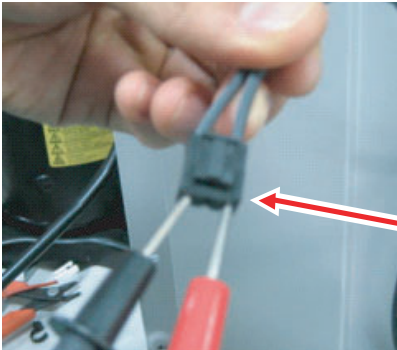

*Normal value: several kΩ

4way valve connector location in main PCB
(It is marked as CN16_VI, CN25_BK)

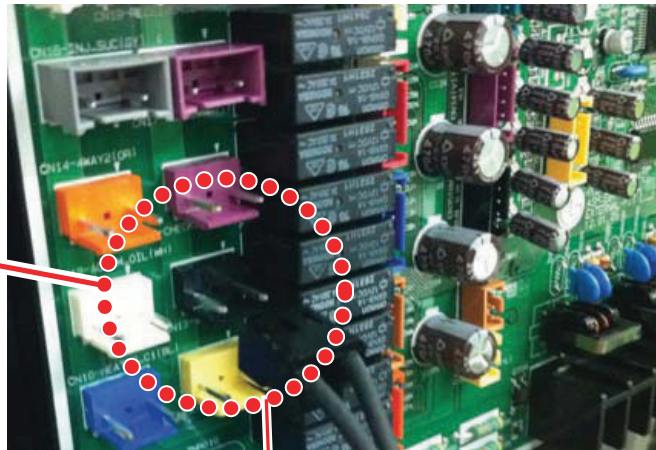

(Note 2) Check if the coil is fully inserted in 4way valve.

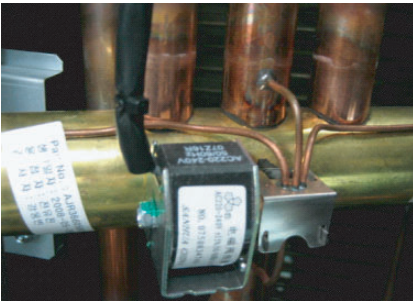

(Note 3) During the heating operation, check if 220V is output from PCB

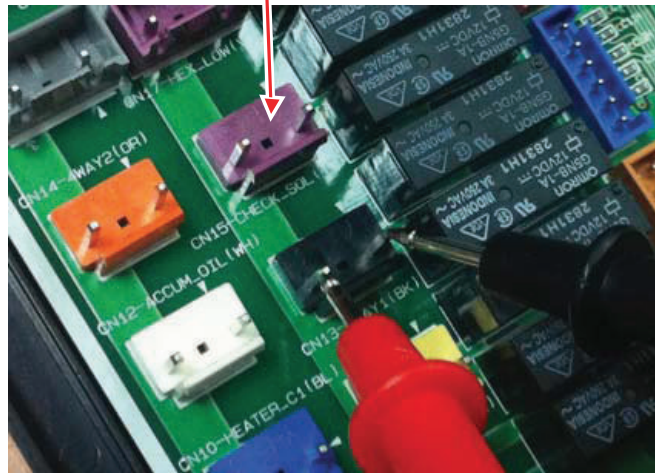

Error code check

Error No.	Error Type	Error Point	Main Reasons
193 (11→931)	Fan board radiator connection temperature excessive increase	In case where radiator detection temperature is more than 95 °C	1. Radiator temperature sensor abnormality 2. Temperature sensor connector connection defect 3. Fan PCB board defect
194 (11→941)	Fan board radiator temperature sensor defect	Radiator temperature sensor abnormality	1. Radiator temperature sensor abnormality (Open/Short) 2. Temperature sensor connector connection defect 3. Fan PCB board defect

■ Failure diagnosis method

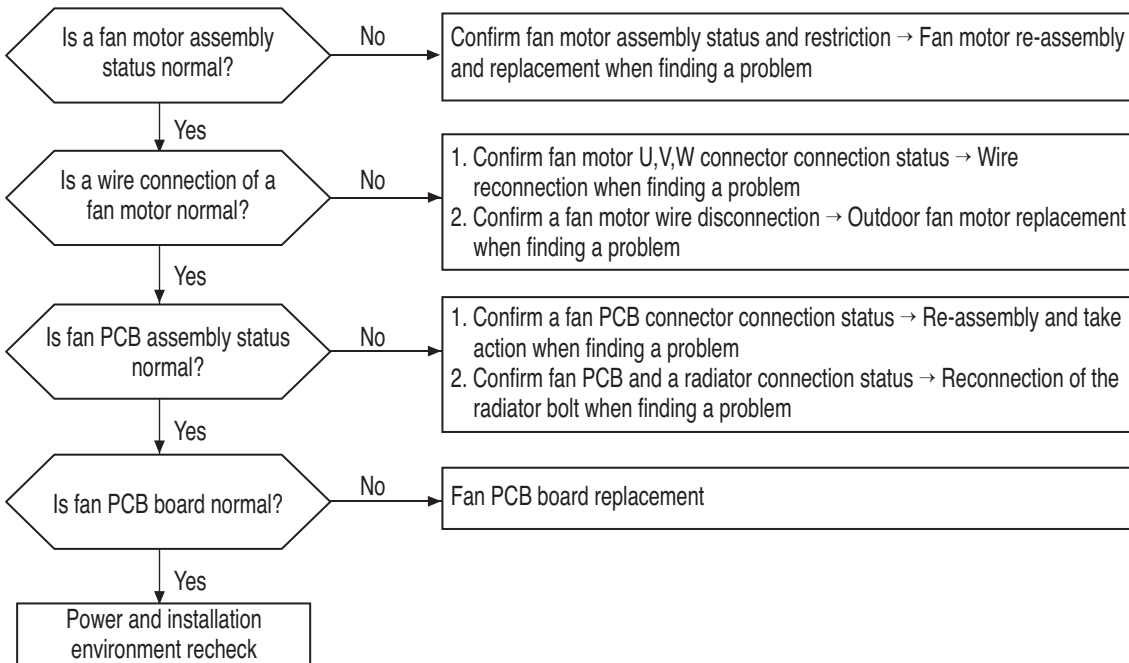

Confirm fan PCB and a radiator connection status

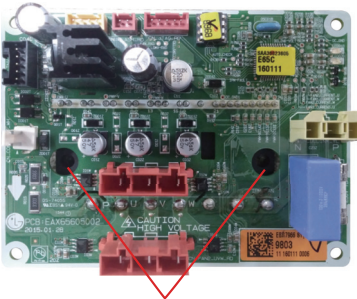

Check Screw Connection Condition

■ Inverter compressor and static speed compressor

When replacing a compressor, please follow the procedure to replace

- Before replacing a compressor, please judge if it is an inverter compressor failure or a static speed compressor failure and then replace.
- Especially replacing an inverter compressor 2 to 3 times, please replenish FW68D(PVE).
 - 1) Please confirm if the main power is off
 - 2) Please remove refrigerant by connecting a manifold gauge to a service valve

CAUTION

- Since oil can be discharged with when removing refrigerant, please discharge the refrigerant slowly

- 3) Please remove a compressor terminal cover and then remove a power line.
- 4) Please remove a discharge temperature sensor of a compressor and a crankcase heater
- 5) Please remove an installation nut of a compressor
- 6) Please separate the welding part of pipes connecting to a compressor by heating. (Suction pipe, discharge pipe)
- 7) Please replace a compressor

CAUTION

- When replacing a compressor, please be careful not to hurt your waist

- 8) Please install the pipe separated at 7) by re-welding with the compressor
- 9) Please close the service valves of a liquid tube and gas tubes and check if there is a leakage or not by injecting nitrogen gas 38kgf/cm²g through a check joint of low pressure and high pressure sides
- 10) Please degas the nitrogen gas
- 11) Please open a manifold gauge and then vacuum
- 12) Please install a crankcase heater

CAUTION

- When installing a crankcase heater, please make sure differentiate two crankcase heaters and then install correct valve heater corresponding the compressor

- 13) Please install a discharge temperature sensor of a compressor and its insulator
- 14) Please connect a power line by a compressor terminal

CAUTION

- When connecting a phase, please be careful not to make a reverse phase and Omitting

- 15) If finishing vacuuming, please recharge the refrigerant
- 16) Please confirm if the power line is correctly connected to the compressor terminal and then check insulation resistance
Please cover a compressor terminal cover, turn the power on and then check if current is flew through the crankcase heater
- 17) Please operate the product and then check if operating normally

Compressor

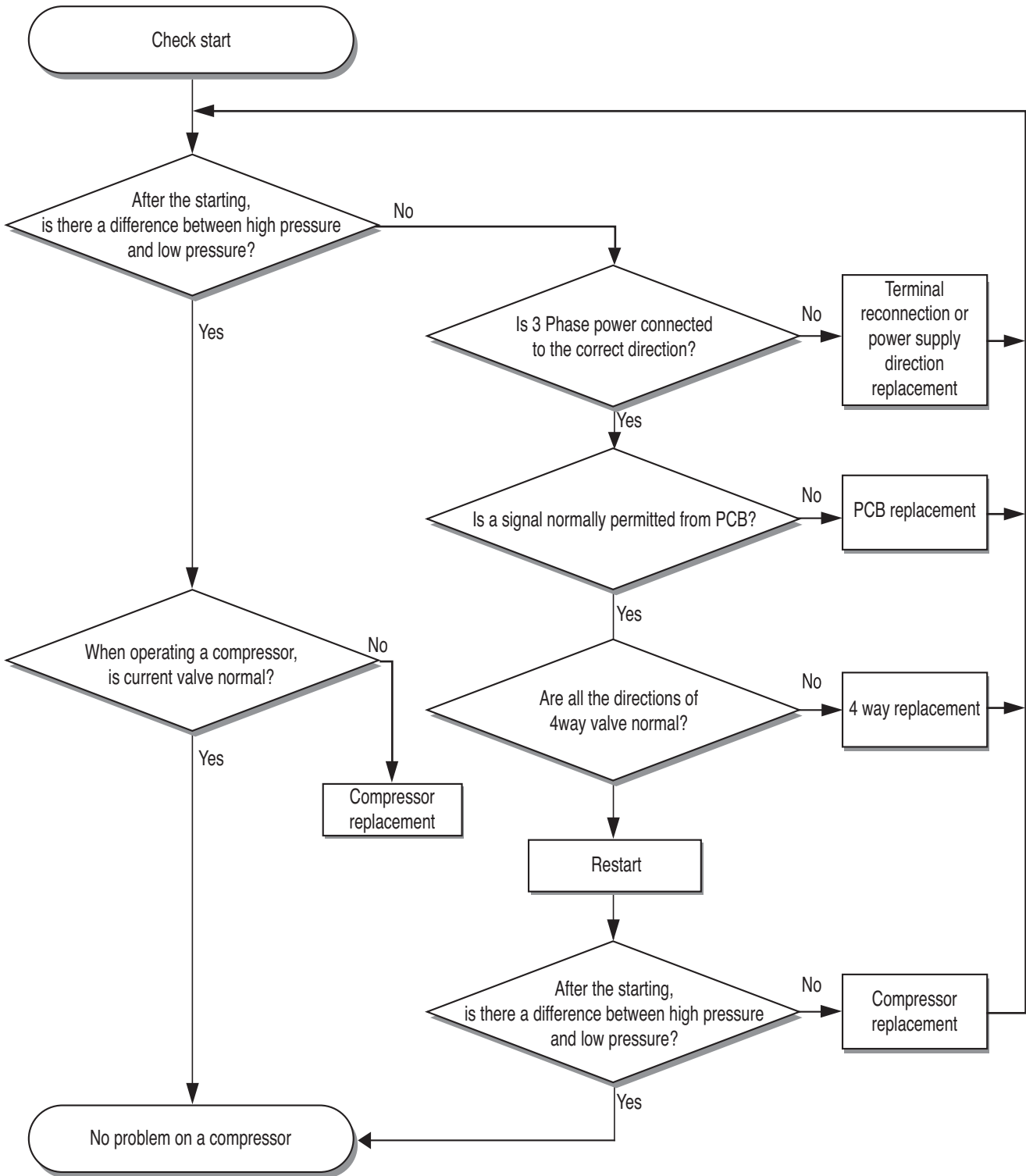

EEV

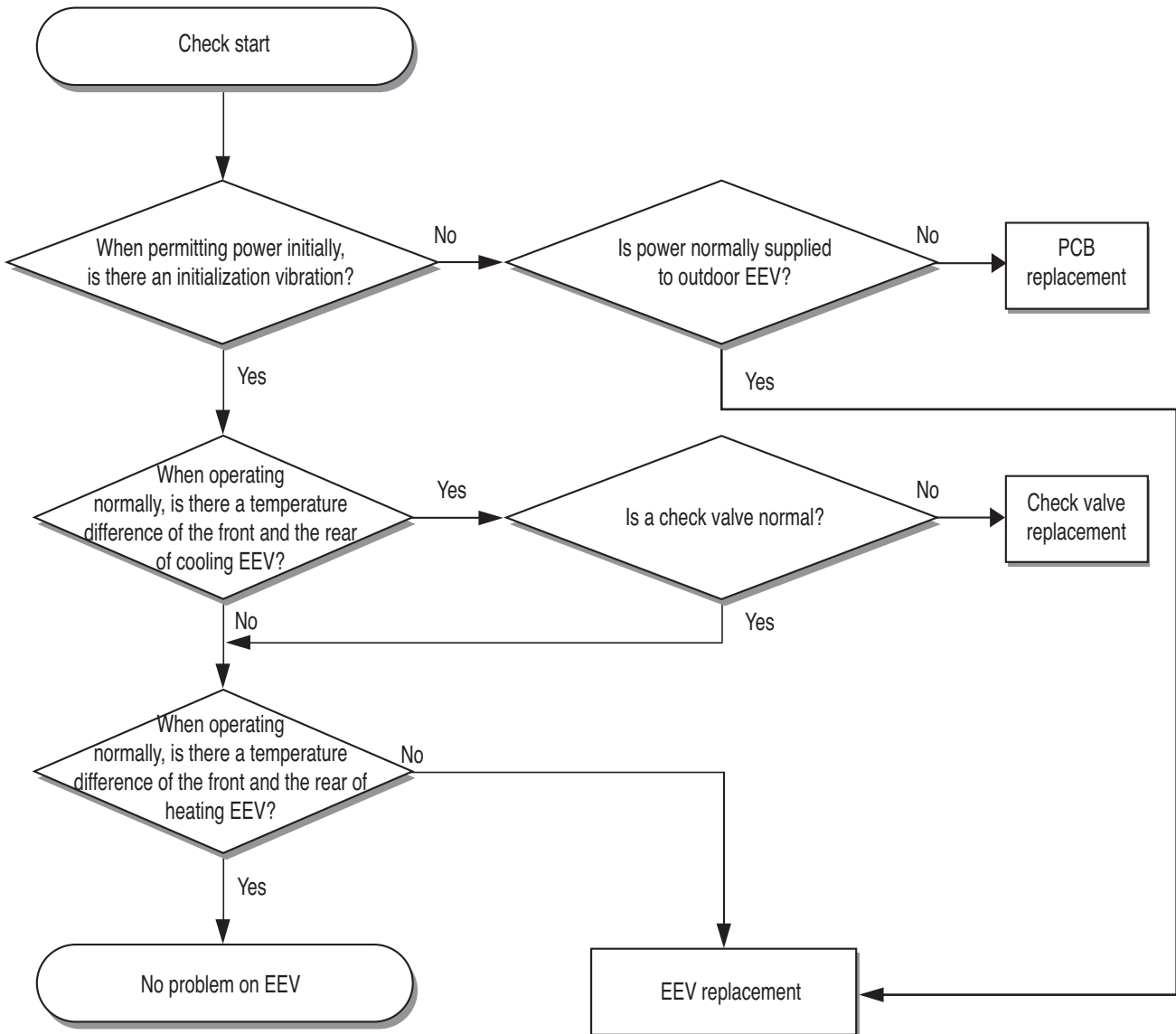

Sub cooling EEV

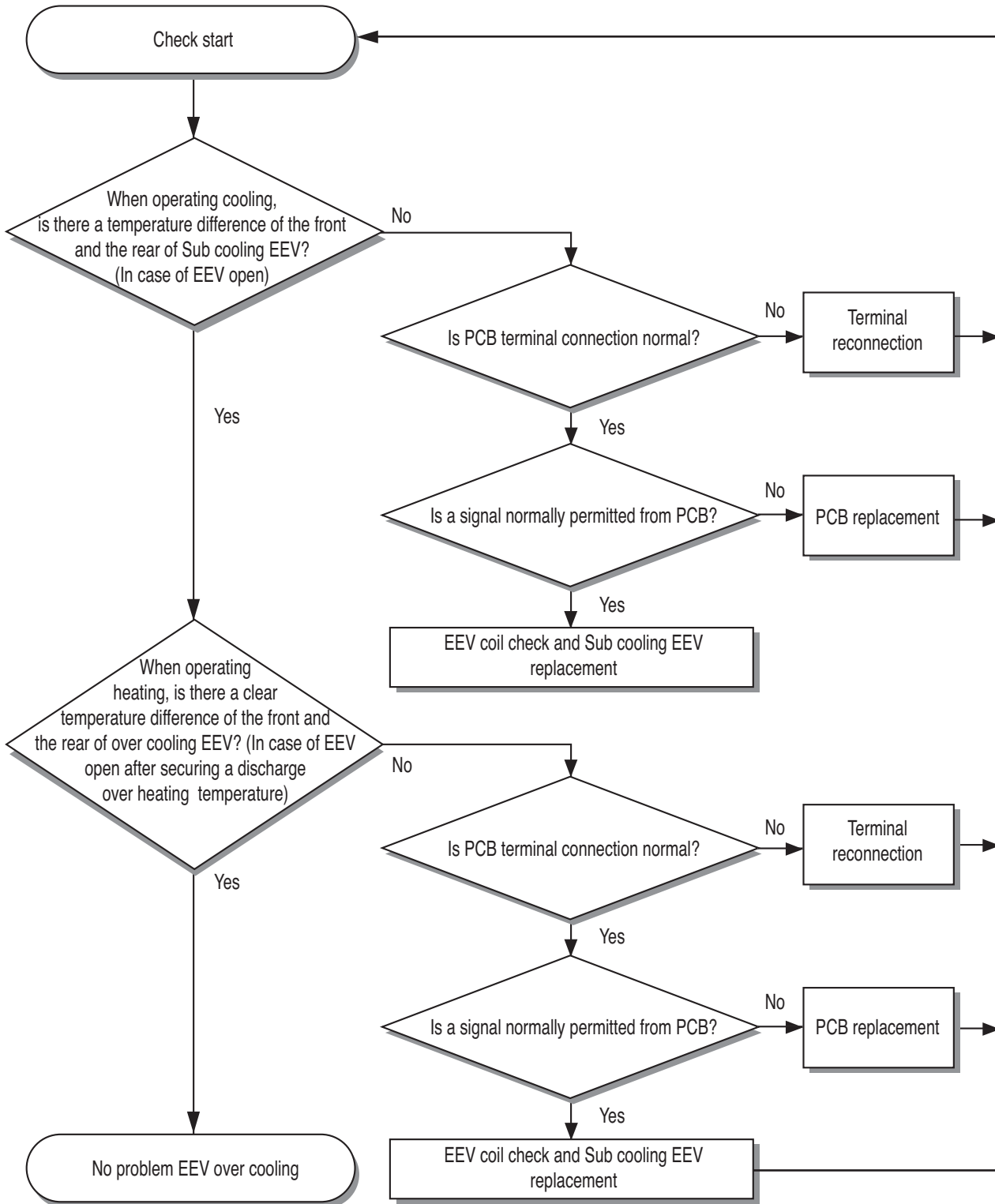

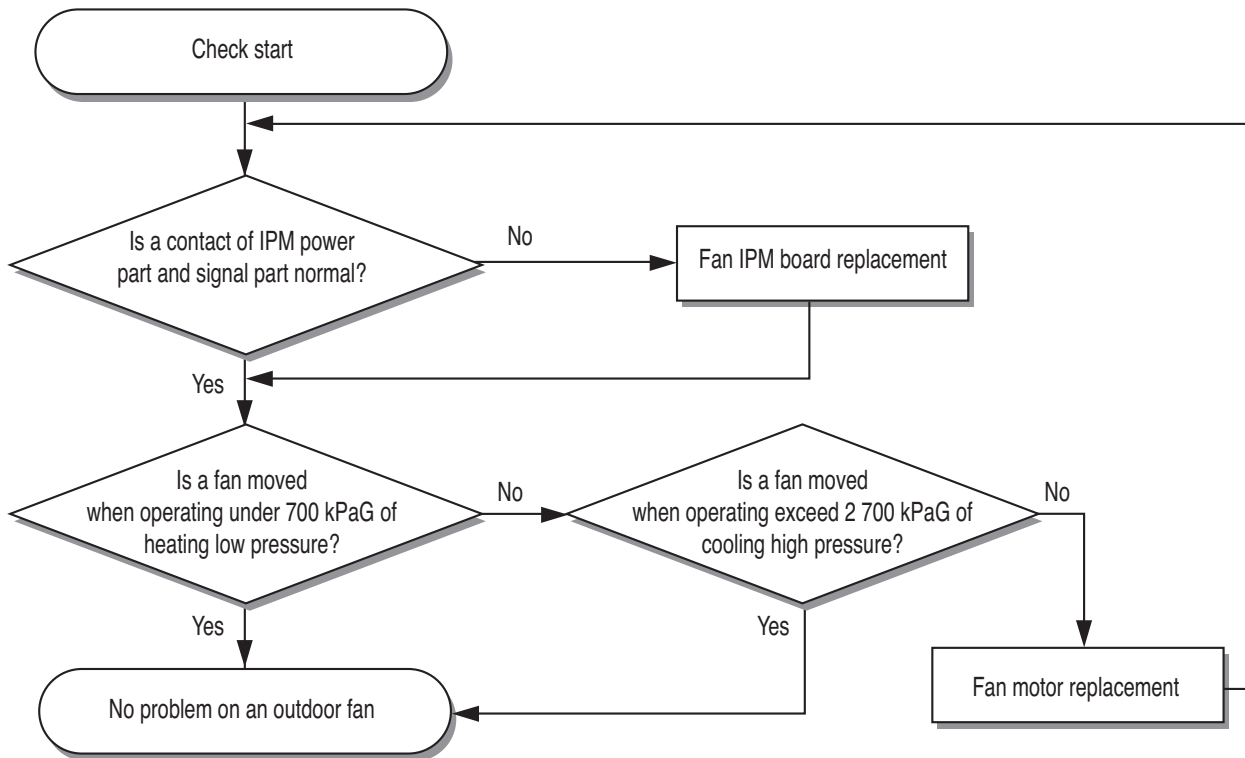
Inverter outdoor fan

Temperature sensor

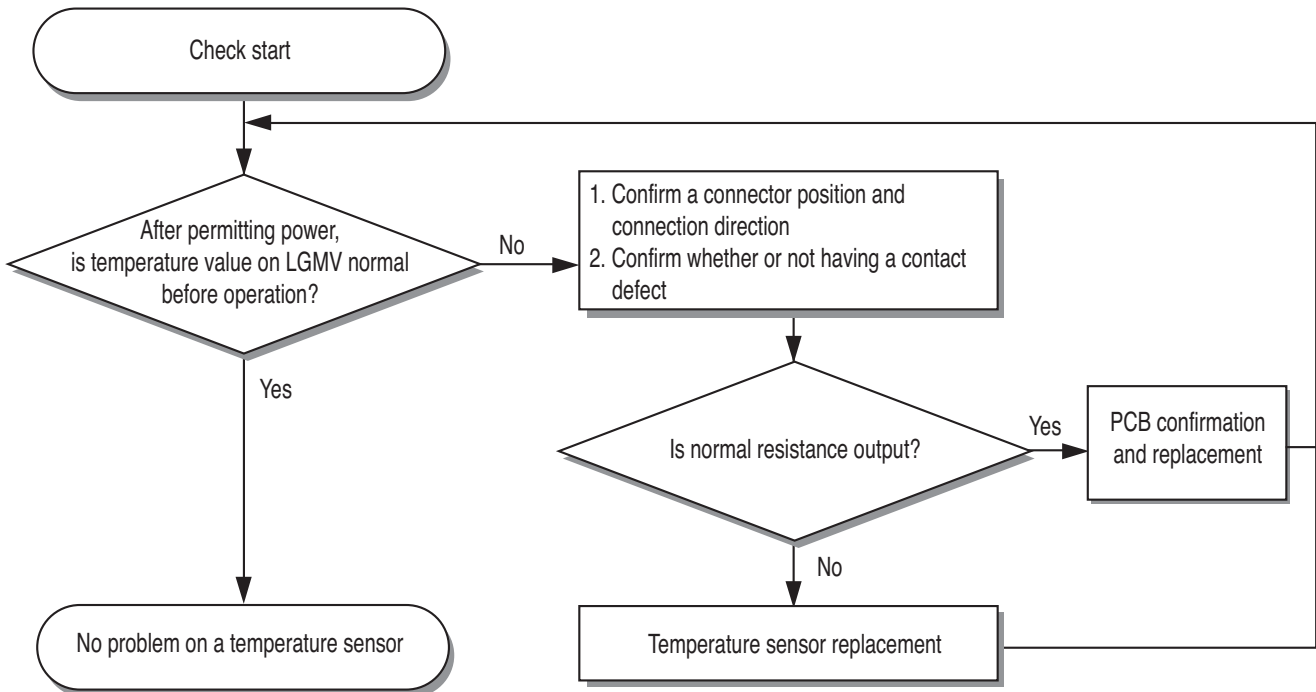

High voltage pressure sensor

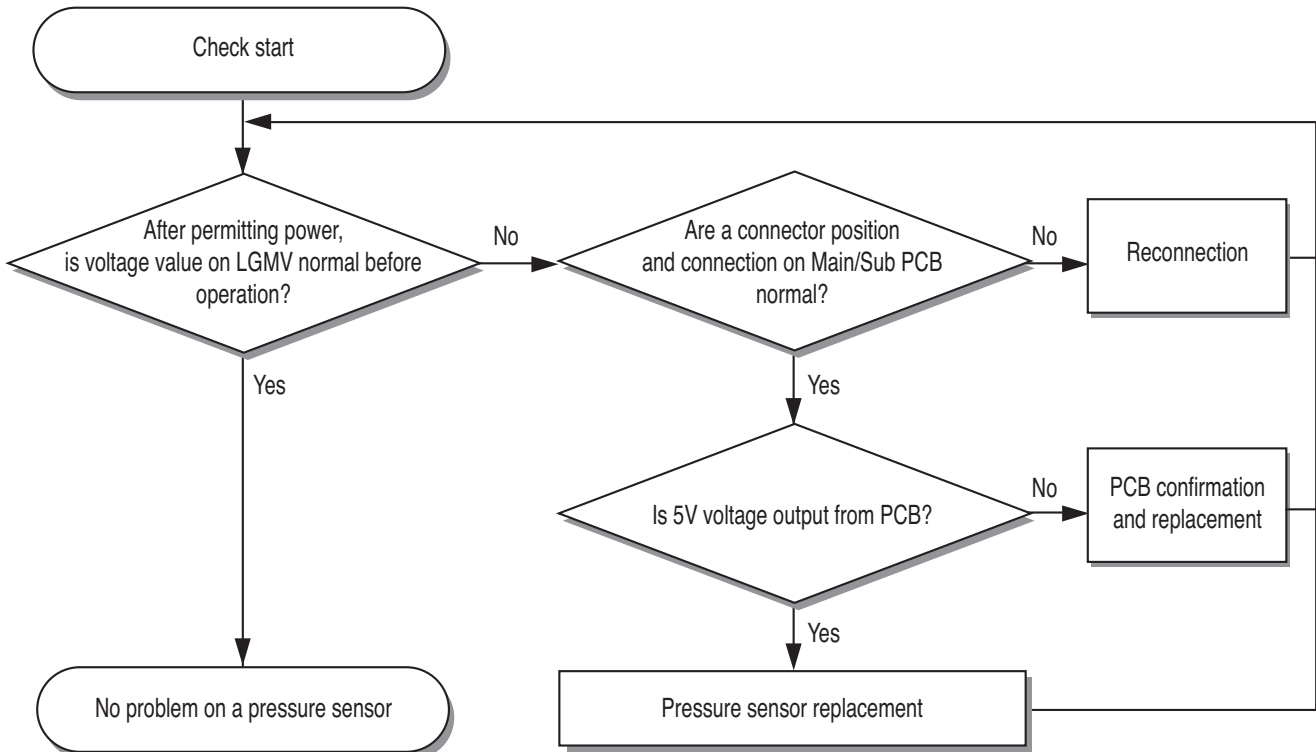

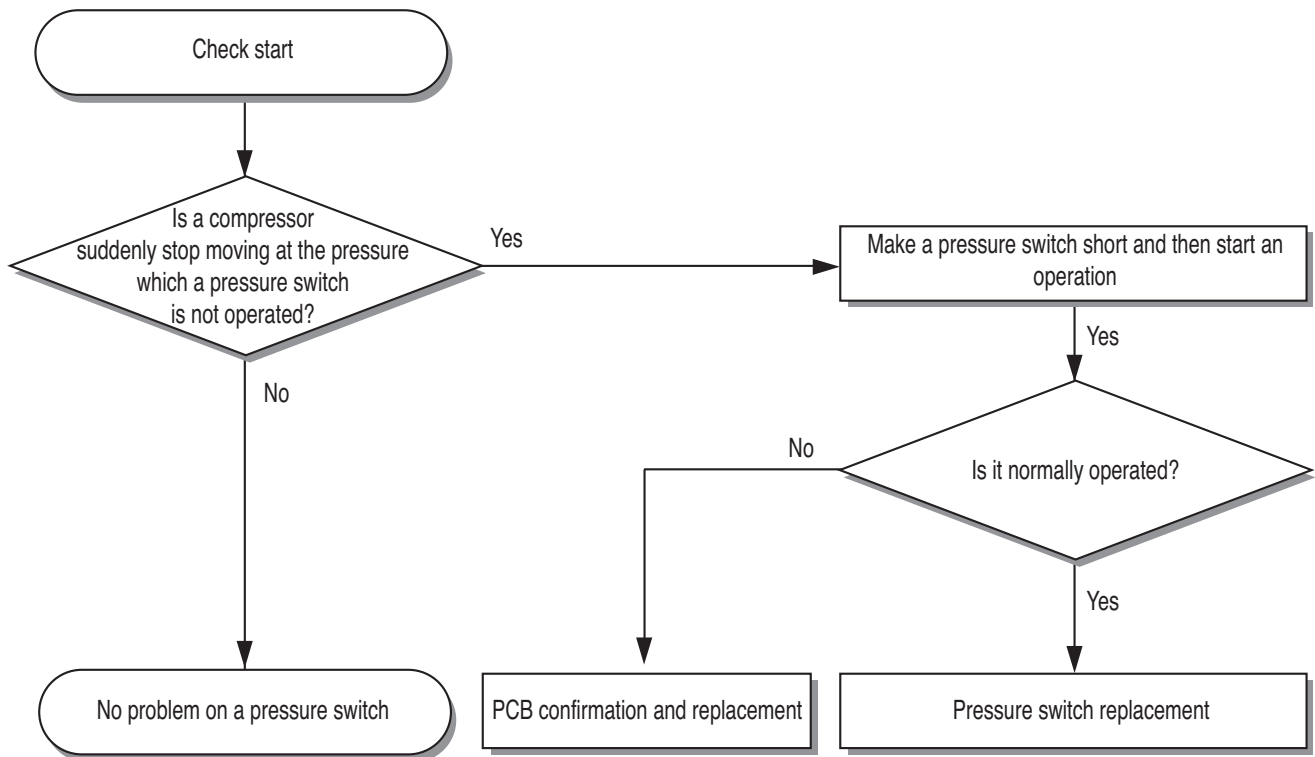
Pressure switch**CAUTION**

- If operating as the pressure switch power is shut for a long time, pipes and parts of the system can get severe damage.

9. Additional functions

Vacuum mode

If you need vacuum after service at the product installation site, when you set vacuum mode function, all valves and EEV are open.

1. Turn on Cycle Main PCB DIP S/W No. 4.

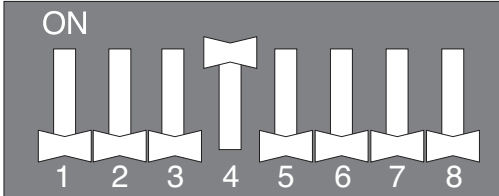

2. Press SW02C button to check Suc in Segment window.



3. Press SW01D button 1 time.



4. Press SW02C button to check Se3 in Segment window.



5. Press SW01D button 1 time.



6. Vacuum mode setting is completed.

* It is cleared when you reset the power.

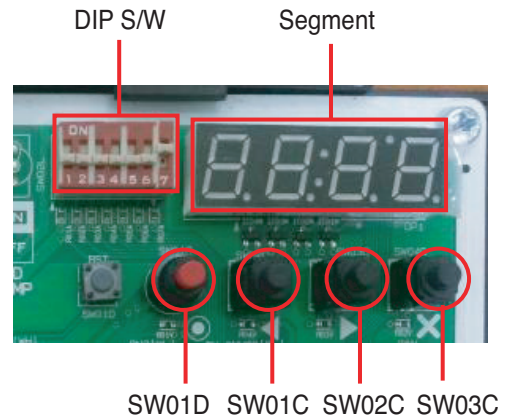

Inlet and outlet temperature difference setting mode

In the refrigeration cycle, the inlet and outlet temperature difference is $\Delta T = 5^{\circ}\text{C}$.

This value can be changed at the time of on-site installation.

At this time, the flow rate should be reduced in inverse proportion to the changing inlet and outlet temperature difference.

Flow S/W limit should be set on site when the flow rate decreases.

The setting below is for $\Delta T = 10^{\circ}\text{C}$.

• Mode on

1. Turn on Cycle Main PCB Dip S/W No. 5.

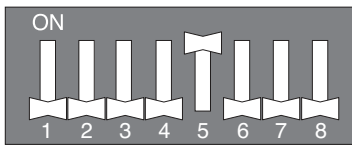

2. Check Func in the Segment window.



3. Press the SW03C button to set Fn07 in the Segment window.



4. Press the SW01C button to confirm Fn07.



5. Press the SW03C button to check OP2 in Segment window.



Setup	Details	Flow rate change
OP1	$\Delta T=7^{\circ}\text{C}$	63% compared to $\Delta T=5^{\circ}\text{C}$
OP2	$\Delta T=10^{\circ}\text{C}$	50% compared to $\Delta T=5^{\circ}\text{C}$

6. Press the SW01C button to confirm OP2.



7. Large temperature difference mode setting.

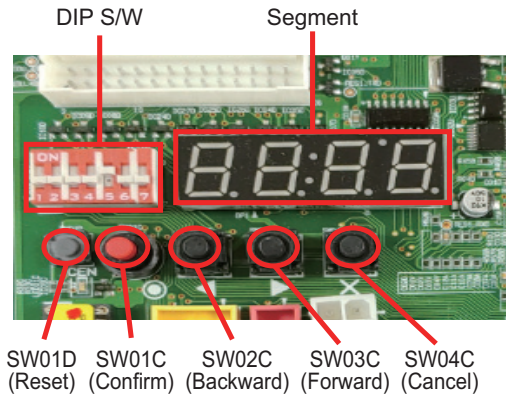

• Mode off

1. Turn on Cycle Main PCB Dip S/W No. 5.

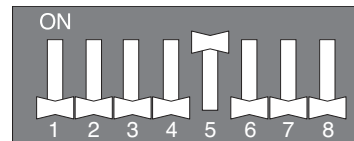

2. Check Func in the Segment window.



3. Press the SW03C button to set Fn07 in the Segment window.



4. Press the SW01C button to confirm Fn07.



5. Press the SW02C button to set OFF in the Segment window.



6. Press the SW01C button to confirm OFF.



7. Large temperature difference mode is turned off.



P/NO : MFL67288422