

LG

Single Standard

Heat pump, R410A

MFL67986347

TOTAL HVAC SOLUTION PROVIDER

ENGINEERING PRODUCT DATA BOOK

Single Standard
General Information

Model Line Up

1. Model Line Up

Product	Phase	Chassis	Capacity Index	Model Name	Combination Indoor Unit
			kW		
Standard	1	U18A	5.3	ATUW18GPLP1	ATNW18GPLP1
				ATUW18GTLP1	ATNW18GTLP1
		U24A	7.0	ATUW24GPLP1	ATNW24GPLP1
				ATUW24GTLP1	ATNW24GTLP1
		U36A	10.6	ATUW36GNLP1	ATNW36GNLP1
				AVUW36GM1P1	AVNW36GM1P1
		U60A	14.1	ATUW48GMLP1	ATNW48GMLP1
				AVUW48GM2P1	AVNW48GM2P1
			17.6	ATUW60GMLP1	ATNW60GMLP1
				AVUW60GM2P1	AVNW60GM2P1

* The capacity index may differ from actual capacity values.

**Single Standard
Product Data**

1. ATUW18GPLP1 + ATNW18GPLP1

1.1 Specifications

Category		Unit	Specification
Major	Minor		
Classification	Chassis	-	U18A
	Cooling / Heating	-	H/P
Power Supply	Case 1	-	220, 1, 60
	Case 2	-	-
	Limit Range of Voltage(Case 1)	V	198~242
	Limit Range of Voltage(Case 2)	V	-
Cooling Capacity	Rated	kW	5.28
		Btu/h	18,000
	Min ~ Max	kW	2.10~5.85
		Btu/h	7,200~20,000
	Sensible	kW	4.96
		Btu/h	16,920
Heating Capacity	Rated	kW	5.28
		Btu/h	18,000
	Min ~ Max	kW	2.10~6.15
		Btu/h	7,200~21,000
Power Input(Cooling)	Rated	kW	1.54
	Min ~ Max	kW	--
Power Input(Heating)	Rated	kW	1.35
	Min ~ Max	kW	--
Efficiency	EER	W/W	3.43
	COP	W/W	3.91
	SEER	Wh/Wh	6.63
Running Current(Cooling)	Rated	A	7.00
	Min/Max	A	- / -
Running Current(Heating)	Rated	A	6.10
	Min/Max	A	- / -
Running Current	Max	A	11.00
Power Factor(Cooling/Heating)	Rated	-	0.99 / 0.99
Outdoor Fan	Type	-	Propeller
	Air Flow Rate(Max)	m ³ /min x No.	28 x 1
	Max. External Static Pressure	Pa	-
Outdoor Fan Motor	Type	-	BLDC
	Drive	-	-
	Output	W x No.	43 x 1
Compressor	Type	-	Twin Rotary
	Model x No.	-	GAT156MAD x 1
	Motor Type	-	BLDC
	Motor Output	W x No.	1,500 x 1
	Oil Type	-	POE or PVE
	Oil Charging amount	cc x No.	400 x 1
Heat Exchanger	Rows x Columns x FPI	-	2 x 24 x 14
	No.	-	1
	Fin Type	-	Wide Louver Plus
	Corrosion Protection (Coating)	-	-
	Material (Tube / Fin)	-	-
	Face Area	m ²	-
Dimensions	Net(W x H x D)	mm	770 x 545 x 288
	Shipping(W x H x D)	mm	920 x 585 x 388
Weight	Net	kg	32.7

1. ATUW18GPLP1 + ATNW18GPLP1

Category		Unit	Specification
Major	Minor		
Weight	Shipping	kg	34.9
Exterior	Color	-	Warm Gray
	RAL (Classic)	-	RAL 7044
Protection Device	High Pressure Prevention	-	-
	Frost Prevention	-	-
	Discharge Temperature Control	-	-
	Inverter Protection	-	-
Refrigerant	Type	-	R410A
	Precharged Amount	kg	1.300
	Additional Charging amount	g/m	20
	GWP(Global Warming Potential)	-	2,087.5
	t-CO ₂ eq.	-	2.714
	Chargeless-Pipe Length	m	7.5
	Control Type	-	EEV
Connecting Pipe	Liquid	mm(inch)	Φ6.35 (1/4)
	Gas	mm(inch)	Φ12.7 (1/2)
Pipe Connecting Socket	Liquid	mm(inch)	Φ6.35 (1/4)
	Gas	mm(inch)	Φ12.7 (1/2)
	Connection Type(Liquid)	-	Flare
	Connection Type(Gas)	-	Flare
Piping Length Limit	IDU - ODU(Rated / Max / Min)	m	5 / 30 / 5
Maximum Height Difference	IDU - ODU(Max)	m	20
Sound Pressure Level (Outdoor Unit)	Cooling / Heating (@ 1.5m height)	dB(A)	49.0 / 52.0
Measurement Standard (Pressure Level)	-	-	ISO 3745
Sound Power Level (Outdoor Unit)	Cooling / Heating	dB(A)	-
Measurement Standard (Power Level)	-	-	-
Connecting Cable	Power Supply Cable(H07RN-F)	mm ² × cores	2.5 x 3C
Electrical Characteristic	Minimum Circuit Amperes (MCA)	A	13.4
	Maximum Fuse Amperes (MFA)	A	15
	Comp_Rated Load Amperes (Max)	A	10.0
	Outdoor Fan Motor_Full Load Amperes (FLA)	A	0.25

Note

- Due to our policy of innovation some specifications may be changed without notification.
- Wiring cable size must comply with the applicable local and national codes. And "Electric characteristics" should be considered for electrical work and design. Especially the power cable and circuit breaker should be selected in accordance with that.
- Power factor could vary less than ±1% according to the operating conditions.
- Sound level values are depend on the ambient conditions and values are normally higher in actual operation.
- This product contains Fluorinated greenhouse gases.
- Voltage supplied to the unit terminals should be within the minimum and maximum range.
- Maximum allowable voltage unbalance between phase is 2%.
- MSC means the Max. current during the starting of compressor.
- MSC and RLA are measured as the compressor only test condition.
- OFM and IFM are measured as the outdoor unit test condition.
- Select the wire size based on MCA.
- MFA is used to select the circuit breaker and ground fault circuit interrupter, and all installation site must require attachment of an earth leakage breaker. [circuit breaker type is ELCB(Earth Leakage Circuit Breaker)].
- Performances are based on the following conditions :
 - Cooling : Indoor Ambient Temp. 27°CDB / 19°CWB, Outdoor Ambient Temp. 35°CDB / 24°CWB
 - Heating : Indoor Ambient Temp. 20°CDB / 15°CWB, Outdoor Ambient Temp. 7°CDB / 6°CWB
 - Interconnected Pipe Length is standard length and difference of Elevation (Outdoor ~ Indoor Unit) is 0m.

1. ATUW18GPLP1 + ATNW18GPLP1

1.2 List of Functions

Category	Functions	Availability
Reliability	Defrost / Deicing	O
	High Pressure Switch	X
	Low Pressure Switch	X
	Phase Protection	X
	Restart Delay (3-minutes)	O
	Self Diagnosis	O
	Soft Start	O
Convenience	Night Low Noise Operation	X
	Wiring Error Check	X
	Peak Control	X
	Mode Lock	X
	Forced Cooling Operation (Outdoor Unit)	X
	Advanced SLC (Smart Load Control)	X
Special Functions	ODU Dry Contact Function	X

Note

- O : Applied, X : Not applied
- Accessory : Ordered and purchased separately the accessory package referring to the model name provided and install at field.
- Accessory line-ups varies by region, so check your local catalogue or local sales material.

1. ATUW18GPLP1 + ATNW18GPLP1

1.3 Accessory Compatibility List

Category	Accessory Name	Model Name	Description	Compatibility
Central Controller	AC EZ	PQCSZ250S0	-	O
	AC EZ touch	PACEZA000	Touch type	O
	AC Smart IV	PACS4B000	Touch type	O
	AC Smart 5	PACS5A000	Touch type	O
	ACP IV	PACP4B000	-	O
	ACP 5	PACP5A000	-	O
	AC Manager IV	PACM4B000	For Integrated Control	O
	AC Manager 5	PACM5A000	For Integrated Control	O
Gateway	ODU PI485	PMNFP14A1	For 16-room (3 series)	O
	ACP BACnet	PQNFB17C0	-	O
	ACP Lonwork	PLNWKB000	-	O
	Cloud Gateway	PWFMDB200	-	O
Integration Device	AHU comm. kit	PAHCMR000	For AHU Control (Multi V / Single ODU Communication)	O
		PAHCMS000	For AHU Control (Multi V / Single ODU Communication)	X
	AHU Controller Module	PAHCMC000	For AHU Control (Communication Module)	X
		PAHCMM000	For AHU Control (Main Module)	X
	PDI Standard	PPWRDB000	Power distributor 2port	X
	PDI Premium	PQNUD1S40	Power distributor 8port	X

Note

- O: Possible, X: Impossible, -: Unconfirmed or irrelevant
- AC Manager requires ACP or AC Smart.
- Compatibility of individual controller(wireless/wired remote controller) could be found with function list on Indoor Unit's PDB.
- If you need more detail, please refer to the Control(BECON) PDB or the manual of product.
(<http://partner.lge.com/global> : Home> Doc.Library> Product > Control(BECON)).
- Accessory line-ups varies by region, so check your local catalogue or local sales material.

1. ATUW18GPLP1 + ATNW18GPLP1

1.4.2 Install Space

For Side Discharge (capacity < 28.0 kW)

Obstacle on the Suction side

[Unit : mm(inch)]

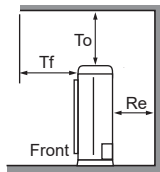

To ≥ 1,000(39-3/8)
Tf ≤ 500(19-11/16)

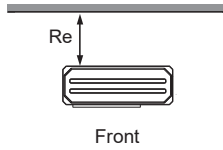

Case 1
Re ≥ 100(3-15/16)
Case 2
Re ≥ 300(11-13/16)

※ Case 1 : No obstacle on top side
Case 2 : Obstacle on top side

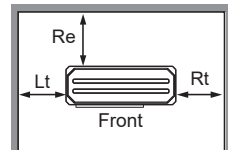

Case 1
Re ≥ 100(3-15/16)
Lt ≥ 100(3-15/16)
Rt ≥ 100(3-15/16)
Case 2
Re ≥ 300(11-13/16)
Lt ≥ 150(5-29/32)
Rt ≥ 150(5-29/32)

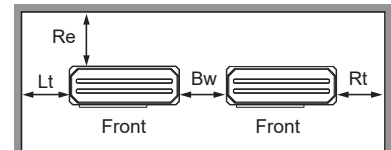

Case 1
Re ≥ 300(11-13/16)
Lt ≥ 1,000(39-3/8)
Rt ≥ 200(7-7/8)
Bw ≥ 100(3-15/16)
Case 2
Re ≥ 300(11-13/16)
Lt ≥ 1,000(39-3/8)
Rt ≥ 200(7-7/8)
Bw ≥ 100(3-15/16)

Obstacle on the Discharge side

※ For Rear Piping / External SVC Valve type / Side-CBOX type
: Re, Lt ≥ 300(11-13/16) and Rt, Bw, Rb ≥ 600(23-5/8) for ALL CASE.

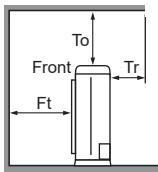
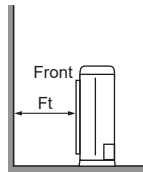

To ≥ 1,000(39-3/8)
Tr ≤ 500(19-11/16)

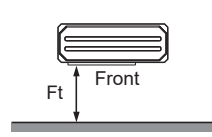

Case 1
Ft ≥ 500(19-11/16)
Case 2
Ft ≥ 500(19-11/16)

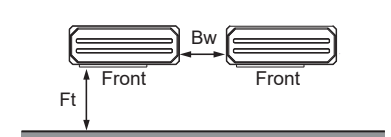

Case 1
Ft ≥ 1,000(39-3/8)
Bw ≥ 100(3-15/16)
Case 2
Ft ≥ 1,000(39-3/8)
Bw ≥ 100(3-15/16)

Obstacle on the Suction and Discharge side

Ld > H (Ls should be lower H.)

※ Close the bottom of the installation frame to prevent the discharged air from being bypassed

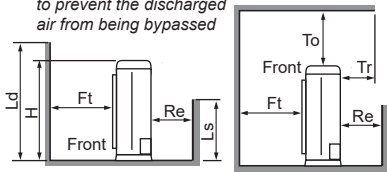

To ≥ 1,000(39-3/8)
Tf ≤ 500(19-11/16)

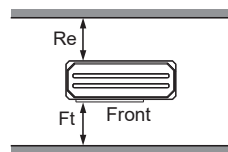

Case 1
Ft ≥ 500(19-11/16)
Re ≥ 300(11-13/16)
Case 2
Ft ≥ 1,000(39-3/8) *
Re ≥ 300(11-13/16)
* If Ls ≤ H/2,
Ft ≥ 750(29-17/32)

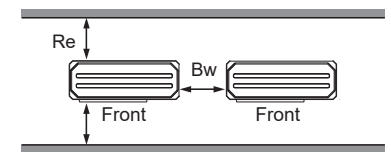

Case 1
Ft ≥ 1,000(39-3/8)
Re ≥ 300(11-13/16)
Bw ≥ 100(3-15/16)
Case 2
Ft ≥ 1,250(49-7/32)
Re ≥ 300(11-13/16)
Bw ≥ 100(3-15/16)

Ld ≤ H

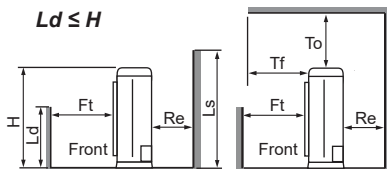

To ≥ 1,000(39-3/8)
Tf ≤ 500(19-11/16)

Case 1
Ft ≥ 500(19-11/16)
Re ≥ 300(11-13/16)
Case 2
Ft ≥ 1,000(39-3/8)
Re ≥ 300(11-13/16)

Case 1
Ft ≥ 1,500(59-1/16)
Re ≥ 300(11-13/16)
Bw ≥ 100(3-15/16)
Case 2
Ft ≥ 1,500(59-1/16)
Re ≥ 300(11-13/16)
Bw ≥ 100(3-15/16)

※ In case of series installation (2 Units or more) for 2 Fan models, Ld should be lower than H/2.

Collective/Continuous Installation (Multiple Columns)

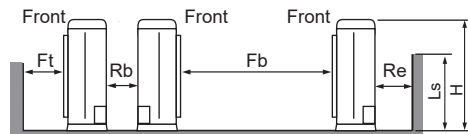

※ In case of Multiple columns/continuous installation, Ls should be lower than H.

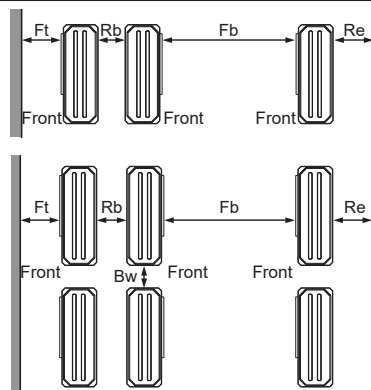

1 Column

Ft ≥ 1,000(39-3/8)
Rb ≥ 200(7-7/8)
Fb ≥ 2,000(78-3/4)
Re ≥ 100(3-15/16)

Multiple Columns

Ft ≥ 1,500(59-1/16)
Rb ≥ 600(23-5/8)
Fb ≥ 3,000(118-1/8)
Re ≥ 300(11-13/16)
Bw ≥ 100(3-15/16)

Note

- If there is a concern about product performance degradation due to group installation or interference with obstacles, secure an additional separation distance.
- Secure enough space for smooth service and maintenance.
- According to product type, model line up, sales region..etc, applicability of each chassis could be different.

1. ATUW18GPLP1 + ATNW18GPLP1

1.5 Piping Diagrams

1.5.1 Normal

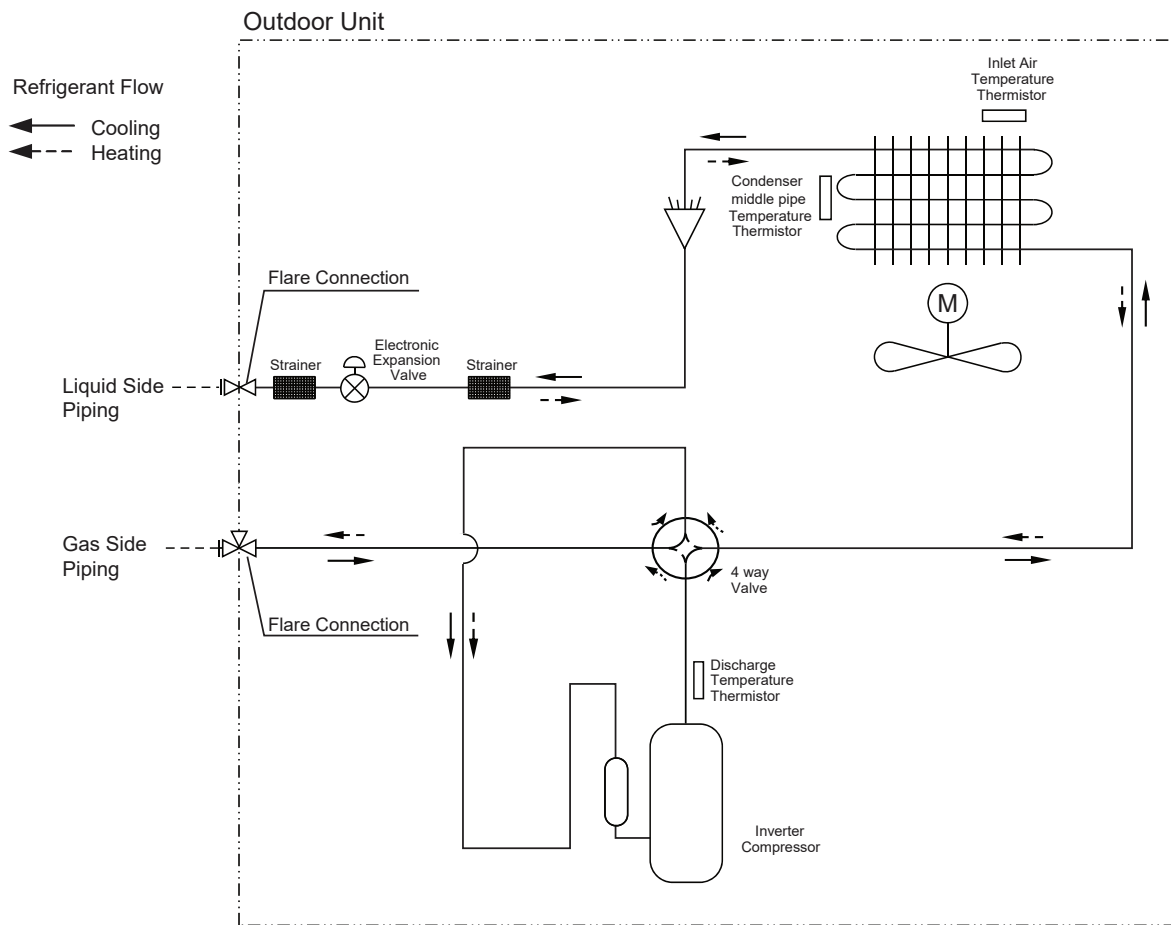

1. ATUW18GPLP1 + ATNW18GPLP1

1.6 Wiring Diagrams

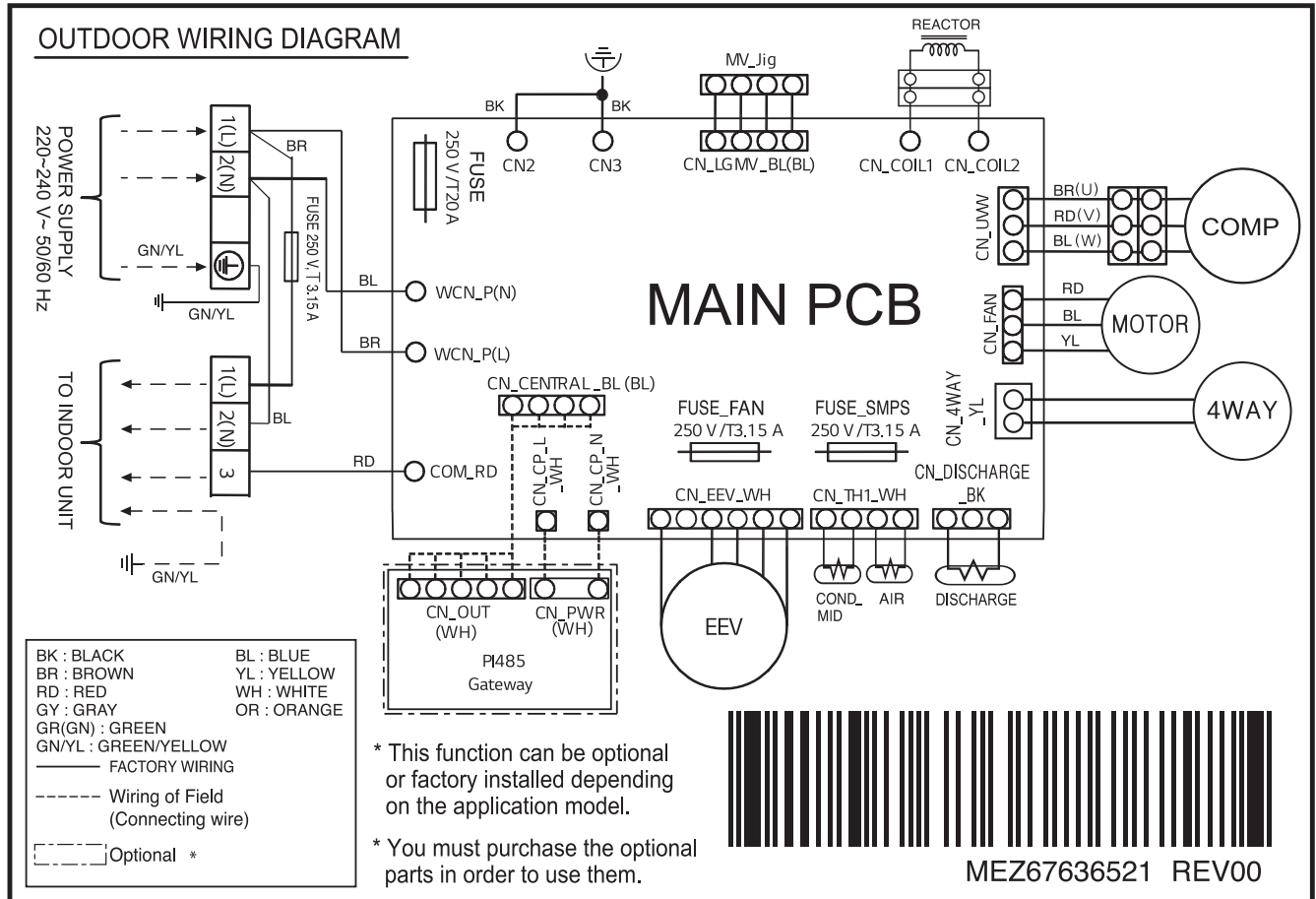

1. ATUW18GPLP1 + ATNW18GPLP1

1.7 Capacity Tables

1.7.1 Cooling

Outdoor Air Temp. (°C, DB)	Indoor Air Temp. (°C, DB/WB)																				
	20.0 / 14.0			22.0 / 16.0			25.0 / 18.0			27.0 / 19.0			28.0 / 20.0			30.0 / 22.0			32.0 / 24.0		
	TC	SHC	PI	TC	SHC	PI	TC	SHC	PI	TC	SHC	PI	TC	SHC	PI	TC	SHC	PI	TC	SHC	PI
20	3.10	3.08	0.63	4.03	3.99	0.79	4.74	4.64	0.91	5.28	4.96	1.00	5.46	4.93	1.01	5.82	4.87	1.03	6.23	4.80	1.04
25	3.10	3.08	0.74	4.03	3.99	0.93	4.74	4.64	1.08	5.28	4.96	1.18	5.46	4.93	1.19	5.82	4.87	1.22	6.23	4.80	1.22
32	3.10	3.08	0.90	4.03	3.99	1.13	4.74	4.64	1.31	5.28	4.96	1.43	5.46	4.93	1.45	5.82	4.87	1.48	6.23	4.80	1.48
35	3.10	3.08	0.97	4.03	3.99	1.21	4.74	4.64	1.40	5.28	4.96	1.54	5.46	4.93	1.56	5.82	4.87	1.59	6.23	4.80	1.60
40	3.10	3.08	1.21	4.03	3.99	1.51	4.74	4.64	1.75	5.28	4.96	1.93	5.46	4.93	1.95	5.82	4.87	1.98	6.23	4.80	1.99
43	3.10	3.08	1.35	4.03	3.99	1.70	4.74	4.64	1.97	5.28	4.96	2.16	5.46	4.93	2.18	5.82	4.87	2.22	6.23	4.80	2.23
46	3.10	3.08	1.51	4.03	3.99	1.90	4.74	4.64	2.03	4.96	4.71	2.07	5.13	4.68	2.09	5.47	4.61	2.13	5.85	4.54	2.14
48	3.10	3.08	1.70	4.03	3.99	1.90	4.74	4.64	1.93	4.78	4.57	1.97	4.91	4.51	1.99	5.18	4.39	2.03	5.49	4.28	2.04
50	3.10	3.08	1.77	4.03	3.99	1.81	4.50	4.44	1.84	4.59	4.43	1.88	4.69	4.34	1.90	4.89	4.17	1.94	5.12	4.01	1.95
52	3.10	3.08	1.68	4.03	3.99	1.72	4.32	4.25	1.75	4.41	4.28	1.79	4.47	4.17	1.81	4.60	3.94	1.84	4.76	3.74	1.85
54	3.10	3.08	1.59	4.03	3.99	1.63	4.14	4.08	1.66	4.22	4.13	1.69	4.25	3.99	1.71	4.31	3.72	1.75	4.39	3.47	1.76

Note

- DB : Dry bulb temperature(°C), WB : Wet bulb temperature(°C)
- TC : Total Capacity(kW), SHC : Sensible Heat Capacity(kW)
- PI : Power Input (kW, Compressor + indoor fan motor + outdoor fan motor)
- All capacities are net. A deduction of capacity due to operating heat of indoor unit motor is reflected.
- Direct interpolation is permissible. Do not extrapolate.
- Rated capacities and power inputs are based on standard temperature and piping conditions, and it can be found on specifications table.
- Except for rated value, the performance is not guaranteed.
- In accordance with the test standard(or nations), the rating will vary slightly.

1. ATUW18GPLP1 + ATNW18GPLP1

1.7.2 Heating

Outdoor Air Temp. (°C, WB)	Indoor Air Temp. (°C, DB)									
	16.0		18.0		20.0		22.0		24.0	
	TC	PI	TC	PI	TC	PI	TC	PI	TC	PI
-5.0	4.81	1.17	4.78	1.28	4.75	1.40	4.73	1.51	4.70	1.62
0.0	5.33	1.40	5.31	1.51	5.28	1.62	5.07	1.53	4.86	1.44
6.0	5.85	1.49	5.56	1.42	5.28	1.35	5.07	1.28	4.86	1.22
10.0	5.85	1.40	5.56	1.28	5.28	1.17	5.07	1.12	4.86	1.07
15.0	5.85	1.17	5.56	1.06	5.28	0.95	5.07	0.91	4.86	0.88
18.0	5.85	1.04	5.56	0.92	5.28	0.81	5.07	0.79	4.86	0.77

Note

- DB : Dry bulb temperature(°C), WB : Wet bulb temperature(°C)
- TC : Total Capacity(kW)
- PI : Power Input (kW, Compressor + indoor fan motor + outdoor fan motor)
- All capacities are net. An addition of capacity due to operating heat of indoor unit motor is reflected.
- Direct interpolation is permissible. Do not extrapolate.
- Rated capacities and power inputs are based on standard temperature and piping conditions, and it can be found on specifications table.
Except for rated value, the performance is not guaranteed.
- In accordance with the test standard(or nations), the rating will vary slightly.

1. ATUW18GPLP1 + ATNW18GPLP1

1.8 Capacity Correction Factor

Operation	Capacity correction factor (%) by Equivalent pipe length (m)										
	5	7.5	10	15	20	25	30	35	40	45	50
Cooling	100.0	99.9	99.8	99.3	98.8	98.3	97.8	-	-	-	-
Heating	100.0	99.9	99.8	99.4	99.0	98.6	98.3	-	-	-	-

Note

In Order to estimate the actual system capacity, the influence of various installation conditions should be reflected.

Reflect the capacity correction factor effect of piping installation as below.

- Q_{odu} [from specification table] : Outdoor unit standard capacity.
- Q(T_i, T_o) [from capacity table] : Outdoor unit capacity at T_i, T_o temperature.
- F(T_i, T_o) = Q(T_i, T_o) / Q_{odu} : Outdoor unit capacity correction factor
- F_{piping} for piping length [from capacity correction factor table] : Piping correction factor
- Indoor unit actual capacity : Q_{actual} = Q_{odu} x F(T_i, T_o) x F_{piping}

1. ATUW18GPLP1 + ATNW18GPLP1

1.9 Operation Limits

1.9.1 Cooling

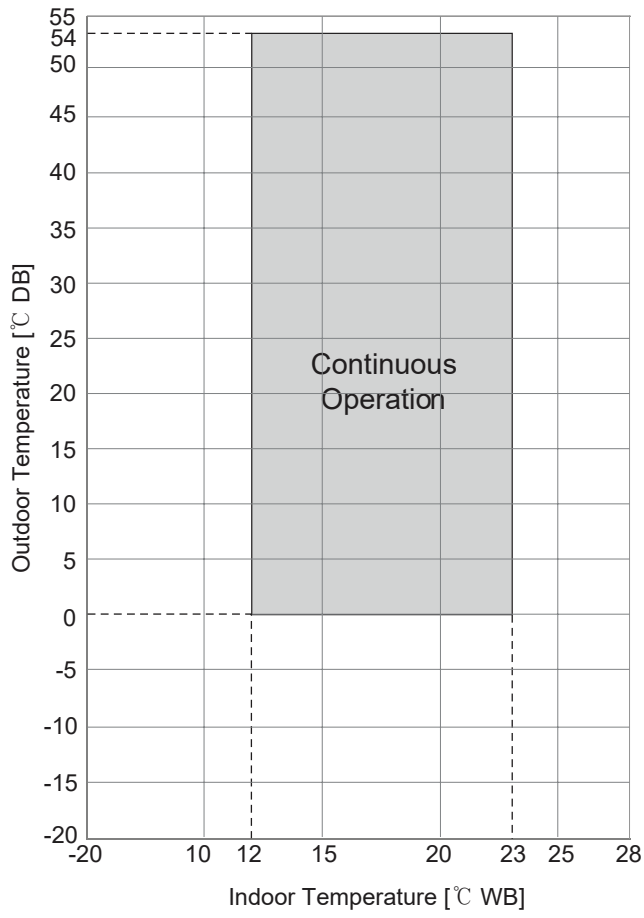

1. ATUW18GPLP1 + ATNW18GPLP1

1.9.2 Heating

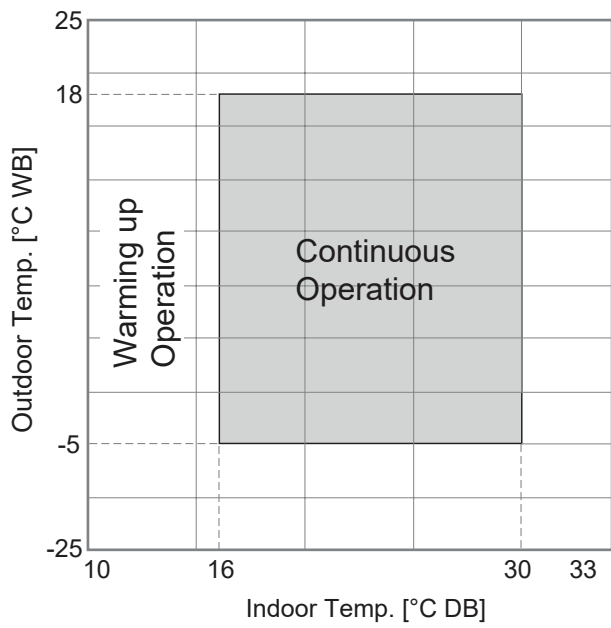

Note

- Warming up operation and operative mean that the outdoor unit operates to reach the range of continuous operating, however it may not operate continuously due to safety or protection logic.

1. ATUW18GPLP1 + ATNW18GPLP1

1.10 Sound Levels

1.10.1 Pressure Levels

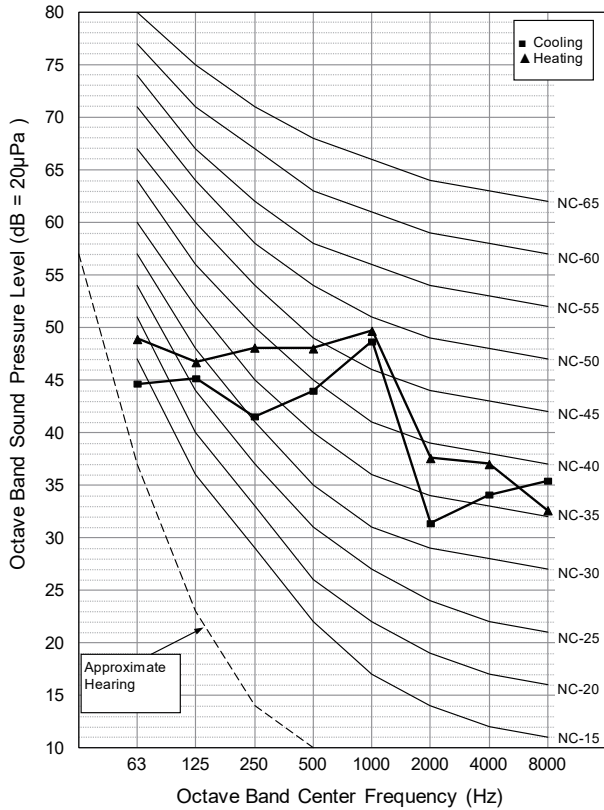

Sound level [dB(A), @ Standard condition]	
Cooling / Heating (@ 1.5m height)	49.0 / 52.0

Note

- Data is valid at diffuse field condition.
- Data is valid at nominal operating condition. Refer to the model specifications for nominal conditions.(Power source and Ambient temperature, etc)
- Reference acoustic pressure 0dB = 20µPa.
- Sound levels can be increased in accordance with installation and operating conditions. (Operating conditions include some functional condition like Static pressure mode, air guide use, Room target temperature setting, etc and these functions are different in accordance with each model.)
- Sound level will vary depending on a range of factors such as the construction(acoustic absorption coefficient) of particular room in which the equipment is installed.
- Sound pressure level is measured on the rated condition in the anechoic rooms by ISO 3745 Standard. Therefore, these values can be increased owing to ambient conditions during operation.

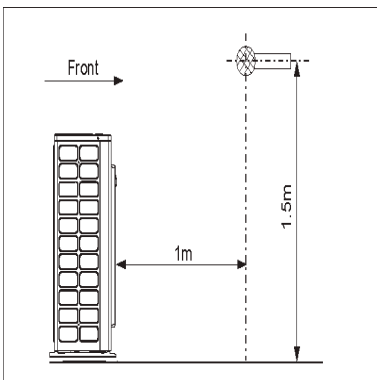

2. ATUW18GTLP1 + ATNW18GTLP1

2.1 Specifications

Category		Unit	Specification
Major	Minor		
Classification	Chassis	-	U18A
	Cooling / Heating	-	H/P
Power Supply	Case 1	-	220, 1, 60
	Case 2	-	-
	Limit Range of Voltage(Case 1)	V	198~242
	Limit Range of Voltage(Case 2)	V	-
Cooling Capacity	Rated	kW	4.69
		Btu/h	16,000
	Min ~ Max	kW	1.80~5.60
		Btu/h	6,100~19,000
	Sensible	kW	3.75
		Btu/h	12,800
Heating Capacity	Rated	kW	5.28
		Btu/h	18,000
	Min ~ Max	kW	1.90~5.80
		Btu/h	6,500~19,800
Power Input(Cooling)	Rated	kW	1.52
	Min ~ Max	kW	~
Power Input(Heating)	Rated	kW	1.55
	Min ~ Max	kW	~
Efficiency	EER	W/W	3.08
	COP	W/W	3.40
	SEER	Wh/Wh	5.77
Running Current(Cooling)	Rated	A	6.90
	Min/Max	A	- / -
Running Current(Heating)	Rated	A	7.00
	Min/Max	A	- / -
Running Current	Max	A	11.00
Power Factor(Cooling/Heating)	Rated	-	0.99 / 0.99
Outdoor Fan	Type	-	Propeller
	Air Flow Rate(Max)	m ³ /min x No.	28 x 1
	Max. External Static Pressure	Pa	-
Outdoor Fan Motor	Type	-	BLDC
	Drive	-	-
	Output	W x No.	43 x 1
Compressor	Type	-	Twin Rotary
	Model x No.	-	GAT156MAD x 1
	Motor Type	-	BLDC
	Motor Output	W x No.	1,500 x 1
	Oil Type	-	POE or PVE
	Oil Charging amount	cc x No.	400 x 1
Heat Exchanger	Rows x Columns x FPI	-	2 x 24 x 14
	No.	-	1
	Fin Type	-	Wide Louver Plus
	Corrosion Protection (Coating)	-	-
	Material (Tube / Fin)	-	-
	Face Area	m ²	-
Dimensions	Net(W x H x D)	mm	770 x 545 x 288
	Shipping(W x H x D)	mm	920 x 585 x 388
Weight	Net	kg	32.7

2. ATUW18GTLP1 + ATNW18GTLP1

Category		Unit	Specification
Major	Minor		
Weight	Shipping	kg	34.9
Exterior	Color	-	Warm Gray
	RAL (Classic)	-	RAL 7044
Protection Device	High Pressure Prevention	-	-
	Frost Prevention	-	-
	Discharge Temperature Control	-	-
	Inverter Protection	-	-
Refrigerant	Type	-	R410A
	Precharged Amount	kg	1.300
	Additional Charging amount	g/m	20
	GWP(Global Warming Potential)	-	2,087.5
	t-CO ₂ eq.	-	2.714
	Chargeless-Pipe Length	m	7.5
	Control Type	-	EEV
Connecting Pipe	Liquid	mm(inch)	Φ6.35 (1/4)
	Gas	mm(inch)	Φ12.7 (1/2)
Pipe Connecting Socket	Liquid	mm(inch)	Φ6.35 (1/4)
	Gas	mm(inch)	Φ12.7 (1/2)
	Connection Type(Liquid)	-	Flare
	Connection Type(Gas)	-	Flare
Piping Length Limit	IDU - ODU(Rated / Max / Min)	m	5/ 30 /5
Maximum Height Difference	IDU - ODU(Max)	m	20
Sound Pressure Level (Outdoor Unit)	Cooling / Heating (@ 1.5m height)	dB(A)	49.0 / 52.0
Measurement Standard (Pressure Level)	-	-	ISO 3745
Sound Power Level (Outdoor Unit)	Cooling / Heating	dB(A)	-
Measurement Standard (Power Level)	-	-	-
Connecting Cable	Power Supply Cable(H07RN-F)	mm ² × cores	2.5 x 3C
Electrical Characteristic	Minimum Circuit Amperes (MCA)	A	13.4
	Maximum Fuse Amperes (MFA)	A	15
	Comp_Rated Load Amperes (Max)	A	10.0
	Outdoor Fan Motor_Full Load Amperes (FLA)	A	0.25

Note

- Due to our policy of innovation some specifications may be changed without notification.
- Wiring cable size must comply with the applicable local and national codes. And "Electric characteristics" should be considered for electrical work and design. Especially the power cable and circuit breaker should be selected in accordance with that.
- Power factor could vary less than ±1% according to the operating conditions.
- Sound level values are depend on the ambient conditions and values are normally higher in actual operation.
- This product contains Fluorinated greenhouse gases.
- Voltage supplied to the unit terminals should be within the minimum and maximum range.
- Maximum allowable voltage unbalance between phase is 2%.
- MSC means the Max. current during the starting of compressor.
- MSC and RLA are measured as the compressor only test condition.
- OFM and IFM are measured as the outdoor unit test condition.
- Select the wire size based on MCA.
- MFA is used to select the circuit breaker and ground fault circuit interrupter, and all installation site must require attachment of an earth leakage breaker. [circuit breaker type is ELCB(Earth Leakage Circuit Breaker)].
- Performances are based on the following conditions :
 - Cooling : Indoor Ambient Temp. 27°CDB / 19°CWB, Outdoor Ambient Temp. 35°CDB / 24°CWB
 - Heating : Indoor Ambient Temp. 20°CDB / 15°CWB, Outdoor Ambient Temp. 7°CDB / 6°CWB
 - Interconnected Pipe Length is standard length and difference of Elevation (Outdoor ~ Indoor Unit) is 0m.

2. ATUW18GTLP1 + ATNW18GTLP1**2.2 List of Functions**

Category	Functions	Availability
Reliability	Defrost / Deicing	O
	High Pressure Switch	X
	Low Pressure Switch	X
	Phase Protection	X
	Restart Delay (3-minutes)	O
	Self Diagnosis	O
	Soft Start	O
Convenience	Night Low Noise Operation	X
	Wiring Error Check	X
	Peak Control	X
	Mode Lock	X
	Forced Cooling Operation (Outdoor Unit)	X
	Advanced SLC (Smart Load Control)	X
Special Functions	ODU Dry Contact Function	X

Note

■ O : Applied, X : Not applied

- Accessory : Ordered and purchased separately the accessory package referring to the model name provided and install at field.
- Accessory line-ups varies by region, so check your local catalogue or local sales material.

2. ATUW18GTLP1 + ATNW18GTLP1

2.3 Accessory Compatibility List

Category	Accessory Name	Model Name	Description	Compatibility
Central Controller	AC EZ	PQCSZ250S0	-	O
	AC EZ touch	PACEZA000	Touch type	O
	AC Smart IV	PACS4B000	Touch type	O
	AC Smart 5	PACS5A000	Touch type	O
	ACP IV	PACP4B000	-	O
	ACP 5	PACP5A000	-	O
	AC Manager IV	PACM4B000	For Integrated Control	O
	AC Manager 5	PACM5A000	For Integrated Control	O
Gateway	ODU PI485	PMNFP14A1	For 16-room (3 series)	O
	ACP BACnet	PQNFB17C0	-	O
	ACP Lonwork	PLNWKB000	-	O
	Cloud Gateway	PWFMDDB200	-	O
Integration Device	AHU comm. kit	PAHCMR000	For AHU Control (Multi V / Single ODU Communication)	O
		PAHCMS000	For AHU Control (Multi V / Single ODU Communication)	X
	AHU Controller Module	PAHCMC000	For AHU Control (Communication Module)	X
		PAHCMM000	For AHU Control (Main Module)	X
	PDI Standard	PPWRDB000	Power distributor 2port	X
	PDI Premium	PQNUD1S40	Power distributor 8port	X

Note

- O: Possible, X: Impossible, -: Unconfirmed or irrelevant
- AC Manager requires ACP or AC Smart.
- Compatibility of individual controller(wireless/wired remote controller) could be found with function list on Indoor Unit's PDB.
- If you need more detail, please refer to the Control(BECON) PDB or the manual of product.
(<http://partner.lge.com/global> : Home> Doc.Library> Product > Control(BECON)).
- Accessory line-ups varies by region, so check your local catalogue or local sales material.

2. ATUW18GTLP1 + ATNW18GTLP1

2.4.2 Install Space

For Side Discharge (capacity < 28.0 kW)

Obstacle on the Suction side

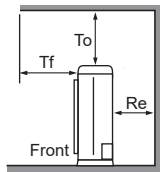

To ≥ 1,000(39-3/8)
Tf ≤ 500(19-11/16)

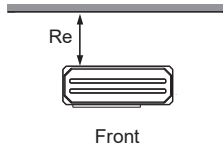

Case 1
Re ≥ 100(3-15/16)
Case 2
Re ≥ 300(11-13/16)

※ Case 1 : No obstacle on top side
Case 2 : Obstacle on top side

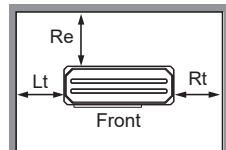

Case 1
Re ≥ 100(3-15/16)
Lt ≥ 100(3-15/16)
Rt ≥ 100(3-15/16)
Case 2
Re ≥ 300(11-13/16)
Lt ≥ 150(5-29/32)
Rt ≥ 150(5-29/32)

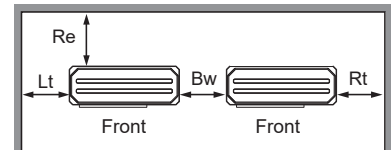

Case 1
Re ≥ 300(11-13/16)
Lt ≥ 1,000(39-3/8)
Rt ≥ 200(7-7/8)
Bw ≥ 100(3-15/16)
Case 2
Re ≥ 300(11-13/16)
Lt ≥ 1,000(39-3/8)
Rt ≥ 200(7-7/8)
Bw ≥ 100(3-15/16)

[Unit : mm(inch)]

Obstacle on the Discharge side

※ For Rear Piping / External SVC Valve type / Side-CBOX type
: Re, Lt ≥ 300(11-13/16) and Rt, Bw, Rb ≥ 600(23-5/8) for ALL CASE.

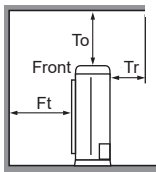
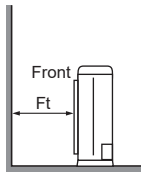

To ≥ 1,000(39-3/8)
Tr ≤ 500(19-11/16)

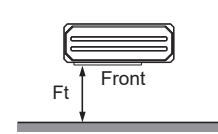

Case 1
Ft ≥ 500(19-11/16)
Case 2
Ft ≥ 500(19-11/16)

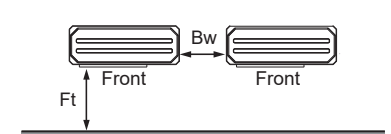

Case 1
Ft ≥ 1,000(39-3/8)
Bw ≥ 100(3-15/16)
Case 2
Ft ≥ 1,000(39-3/8)
Bw ≥ 100(3-15/16)

Obstacle on the Suction and Discharge side

Ld > H (Ls should be lower H.)

※ Close the bottom of the installation frame to prevent the discharged air from being bypassed

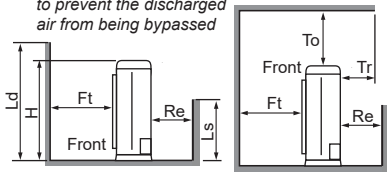

To ≥ 1,000(39-3/8)
Tf ≤ 500(19-11/16)

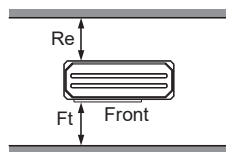

Case 1
Ft ≥ 500(19-11/16)
Re ≥ 300(11-13/16)
Case 2
Ft ≥ 1,000(39-3/8) *
Re ≥ 300(11-13/16)
* If Ls ≤ H/2,
Ft ≥ 750(29-17/32)

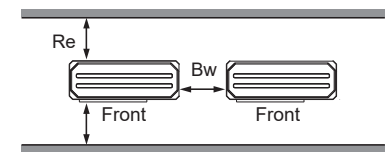

Case 1
Ft ≥ 1,000(39-3/8)
Re ≥ 300(11-13/16)
Bw ≥ 100(3-15/16)
Case 2
Ft ≥ 1,250(49-7/32)
Re ≥ 300(11-13/16)
Bw ≥ 100(3-15/16)

Ld ≤ H

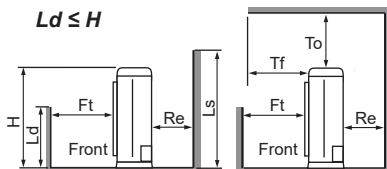

To ≥ 1,000(39-3/8)
Tf ≤ 500(19-11/16)

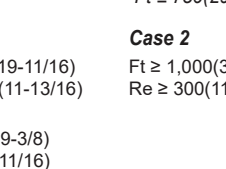

Case 1
Ft ≥ 500(19-11/16)
Re ≥ 300(11-13/16)
Case 2
Ft ≥ 1,000(39-3/8)
Re ≥ 300(11-13/16)

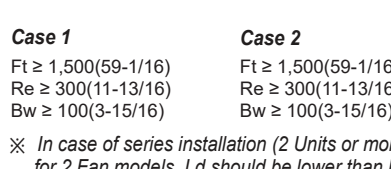

Case 1
Ft ≥ 1,500(59-1/16)
Re ≥ 300(11-13/16)
Bw ≥ 100(3-15/16)
Case 2
Ft ≥ 1,500(59-1/16)
Re ≥ 300(11-13/16)
Bw ≥ 100(3-15/16)

※ In case of series installation (2 Units or more) for 2 Fan models, Ld should be lower than H/2.

Collective/Continuous Installation (Multiple Columns)

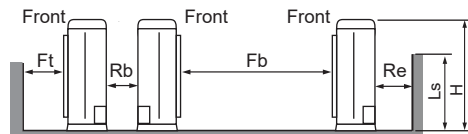

※ In case of Multiple columns/continuous installation, Ls should be lower than H.

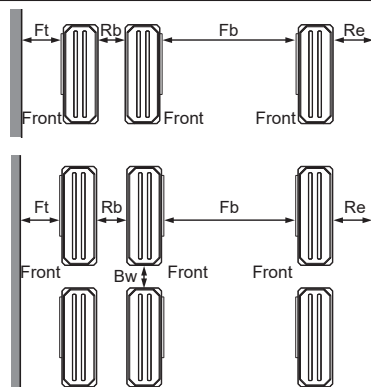

1 Column

Ft ≥ 1,000(39-3/8)
Rb ≥ 200(7-7/8)
Fb ≥ 2,000(78-3/4)
Re ≥ 100(3-15/16)

Multiple Columns

Ft ≥ 1,500(59-1/16)
Rb ≥ 600(23-5/8)
Fb ≥ 3,000(118-1/8)
Re ≥ 300(11-13/16)
Bw ≥ 100(3-15/16)

Note

- If there is a concern about product performance degradation due to group installation or interference with obstacles, secure an additional separation distance.
- Secure enough space for smooth service and maintenance.
- According to product type, model line up, sales region..etc, applicability of each chassis could be different.

2. ATUW18GTLP1 + ATNW18GTLP1

2.5 Piping Diagrams

2.5.1 Normal

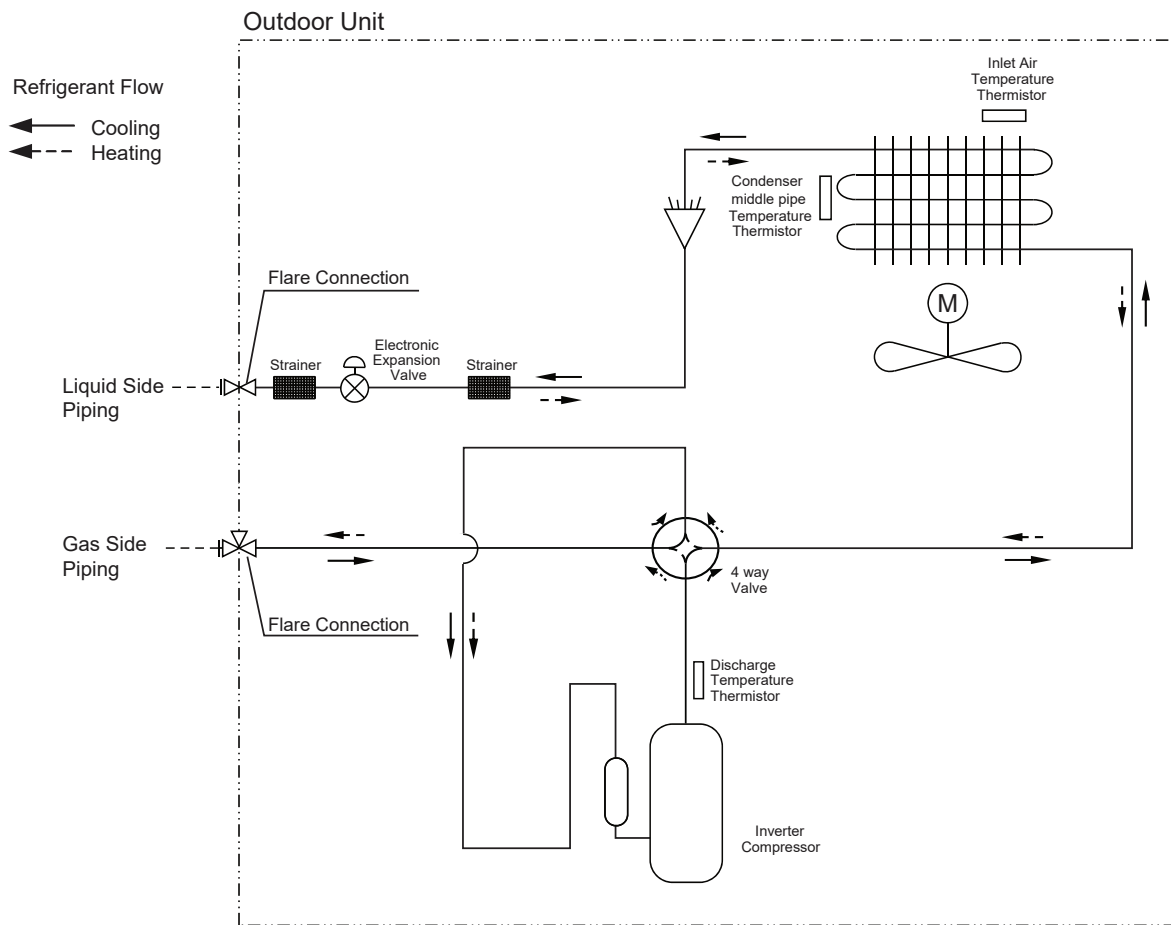

2. ATUW18GTLP1 + ATNW18GTLP1

2.6 Wiring Diagrams

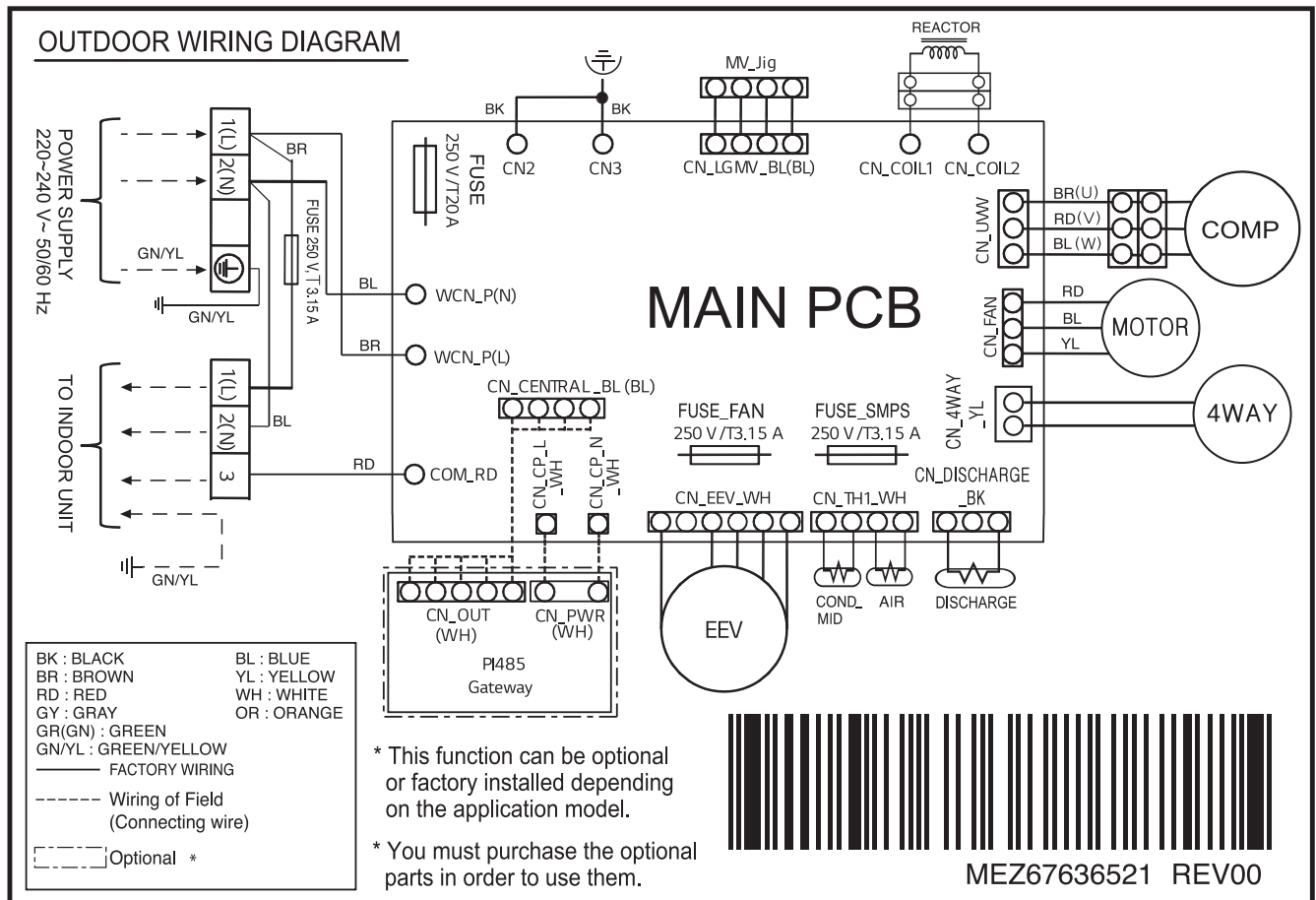

2. ATUW18GTLP1 + ATNW18GTLP1

2.7 Capacity Tables

2.7.1 Cooling

Outdoor Air Temp. (°C, DB)	Indoor Air Temp. (°C, DB/WB)																				
	20.0 / 14.0			22.0 / 16.0			25.0 / 18.0			27.0 / 19.0			28.0 / 20.0			30.0 / 22.0			32.0 / 24.0		
	TC	SHC	PI	TC	SHC	PI	TC	SHC	PI	TC	SHC	PI	TC	SHC	PI	TC	SHC	PI	TC	SHC	PI
20	2.75	2.53	0.62	3.58	3.02	0.78	4.21	3.51	0.90	4.69	3.75	0.99	4.85	3.73	1.00	5.17	3.68	1.02	5.53	3.63	1.02
25	2.75	2.53	0.73	3.58	3.02	0.92	4.21	3.51	1.06	4.69	3.75	1.16	4.85	3.73	1.17	5.17	3.68	1.20	5.53	3.63	1.21
32	2.75	2.53	0.89	3.58	3.02	1.11	4.21	3.51	1.29	4.69	3.75	1.41	4.85	3.73	1.43	5.17	3.68	1.46	5.53	3.63	1.46
35	2.75	2.53	0.95	3.58	3.02	1.20	4.21	3.51	1.39	4.69	3.75	1.52	4.85	3.73	1.54	5.17	3.68	1.57	5.53	3.63	1.57
40	2.75	2.53	1.19	3.58	3.02	1.50	4.21	3.51	1.73	4.69	3.75	1.90	4.85	3.73	1.92	5.17	3.68	1.96	5.53	3.63	1.97
43	2.75	2.53	1.33	3.58	3.02	1.67	4.21	3.51	1.94	4.69	3.75	2.13	4.85	3.73	2.15	5.17	3.68	2.19	5.53	3.63	2.20
46	2.75	2.53	1.49	3.58	3.02	1.88	4.21	3.51	2.00	4.42	3.57	2.04	4.57	3.54	2.06	4.87	3.49	2.10	5.21	3.44	2.11
48	2.75	2.53	1.67	3.58	3.02	1.87	4.21	3.51	1.91	4.25	3.46	1.95	4.37	3.42	1.97	4.61	3.33	2.01	4.88	3.24	2.02
50	2.75	2.53	1.75	3.58	3.02	1.78	4.00	3.36	1.82	4.08	3.35	1.86	4.17	3.29	1.88	4.35	3.16	1.91	4.56	3.04	1.92
52	2.75	2.53	1.66	3.58	3.02	1.69	3.84	3.22	1.73	3.92	3.24	1.76	3.98	3.15	1.78	4.09	2.98	1.82	4.23	2.83	1.83
54	2.75	2.53	1.57	3.58	3.02	1.61	3.68	3.08	1.64	3.75	3.13	1.67	3.78	3.02	1.69	3.83	2.81	1.72	3.90	2.63	1.73

Note

- DB : Dry bulb temperature(°C), WB : Wet bulb temperature(°C)
- TC : Total Capacity(kW), SHC : Sensible Heat Capacity(kW)
- PI : Power Input (kW, Compressor + indoor fan motor + outdoor fan motor)
- All capacities are net. A deduction of capacity due to operating heat of indoor unit motor is reflected.
- Direct interpolation is permissible. Do not extrapolate.
- Rated capacities and power inputs are based on standard temperature and piping conditions, and it can be found on specifications table.
Except for rated value, the performance is not guaranteed.
- In accordance with the test standard(or nations), the rating will vary slightly.

2. ATUW18GTLP1 + ATNW18GTLP1

2.7.2 Heating

Outdoor Air Temp. (°C, WB)	Indoor Air Temp. (°C, DB)									
	16.0		18.0		20.0		22.0		24.0	
	TC	PI	TC	PI	TC	PI	TC	PI	TC	PI
-5.0	4.81	1.34	4.78	1.47	4.75	1.60	4.73	1.73	4.70	1.86
0.0	5.33	1.60	5.31	1.73	5.28	1.86	5.07	1.75	4.86	1.65
6.0	5.85	1.71	5.56	1.63	5.28	1.55	5.07	1.47	4.86	1.40
10.0	5.85	1.60	5.56	1.47	5.28	1.34	5.07	1.28	4.86	1.23
15.0	5.85	1.34	5.56	1.21	5.28	1.09	5.07	1.05	4.86	1.01
18.0	5.85	1.19	5.56	1.06	5.28	0.93	5.07	0.91	4.86	0.89

Note

- DB : Dry bulb temperature(°C), WB : Wet bulb temperature(°C)
- TC : Total Capacity(kW)
- PI : Power Input (kW, Compressor + indoor fan motor + outdoor fan motor)
- All capacities are net. An addition of capacity due to operating heat of indoor unit motor is reflected.
- Direct interpolation is permissible. Do not extrapolate.
- Rated capacities and power inputs are based on standard temperature and piping conditions, and it can be found on specifications table.
Except for rated value, the performance is not guaranteed.
- In accordance with the test standard(or nations), the rating will vary slightly.

2. ATUW18GTLP1 + ATNW18GTLP1

2.8 Capacity Correction Factor

Operation	Capacity correction factor (%) by Equivalent pipe length (m)										
	5	7.5	10	15	20	25	30	35	40	45	50
Cooling	100.0	99.9	99.8	99.3	98.8	98.3	97.8	-	-	-	-
Heating	100.0	99.9	99.8	99.4	99.0	98.6	98.3	-	-	-	-

Note

In Order to estimate the actual system capacity, the influence of various installation conditions should be reflected.

Reflect the capacity correction factor effect of piping installation as below.

- Qodu [from specification table] : Outdoor unit standard capacity.
- Q(Ti, To) [from capacity table] : Outdoor unit capacity at Ti, To temperature.
- F(Ti, To) = Q(Ti, To) / Qodu. : Outdoor unit capacity correction factor
- Fpiping for piping length [from capacity correction factor table] : Piping correction factor
- Indoor unit actual capacity : Qactual = Qodu x F(Ti, To) x Fpiping

2. ATUW18GTLP1 + ATNW18GTLP1

2.9 Operation Limits

2.9.1 Cooling

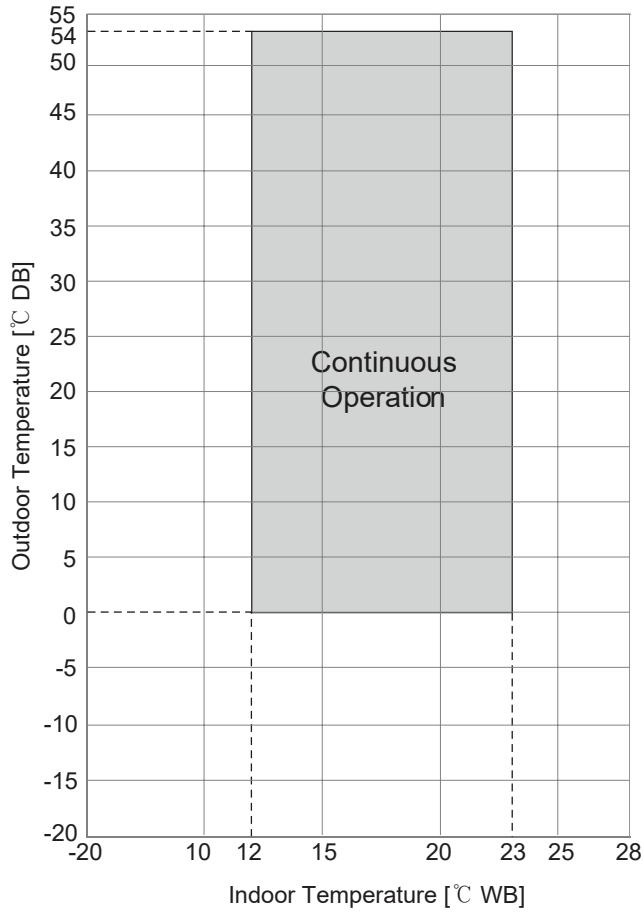

2. ATUW18GTLP1 + ATNW18GTLP1

2.9.2 Heating

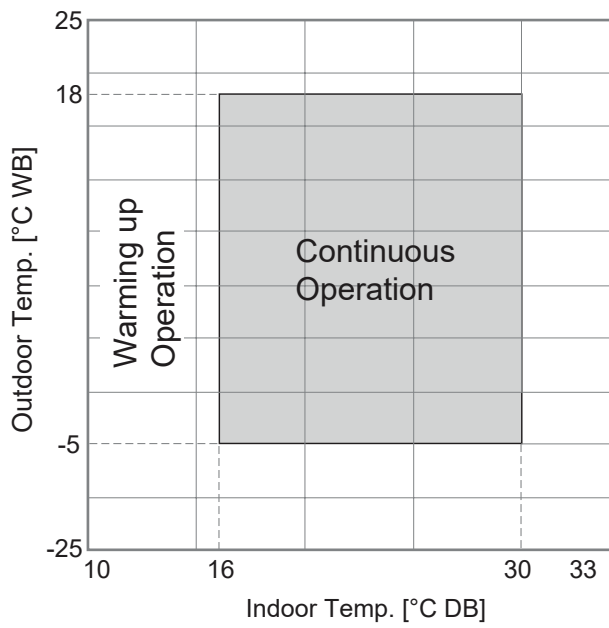
**Note**

- Warming up operation and operative mean that the outdoor unit operates to reach the range of continuous operating, however it may not operate continuously due to safety or protection logic.

2. ATUW18GTLP1 + ATNW18GTLP1

2.10 Sound Levels

2.10.1 Pressure Levels

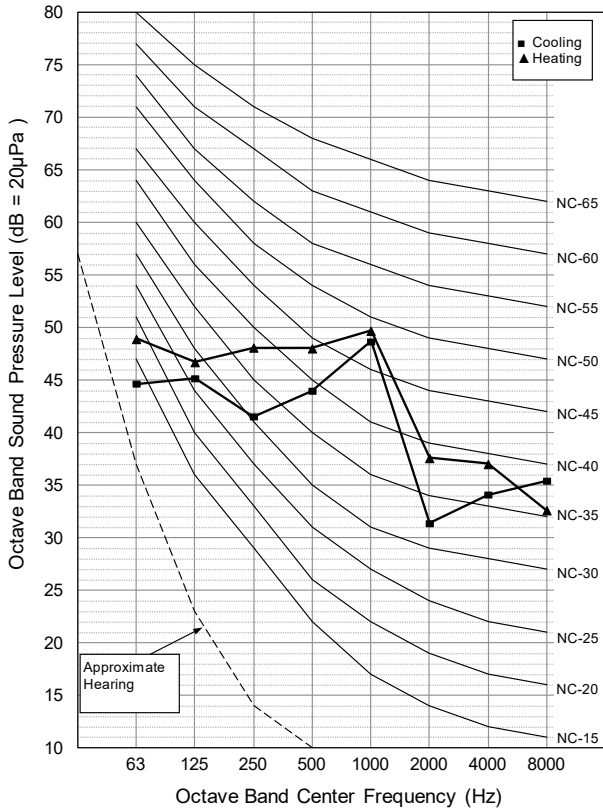

Sound level [dB(A), @ Standard condition]	
Cooling / Heating (@ 1.5m height)	49.0 / 52.0

Note

- Data is valid at diffuse field condition.
- Data is valid at nominal operating condition. Refer to the model specifications for nominal conditions.(Power source and Ambient temperature, etc)
- Reference acoustic pressure 0dB = 20µPa.
- Sound levels can be increased in accordance with installation and operating conditions. (Operating conditions include some functional condition like Static pressure mode, air guide use, Room target temperature setting, etc and these functions are different in accordance with each model.)
- Sound level will vary depending on a range of factors such as the construction(acoustic absorption coefficient) of particular room in which the equipment is installed.
- Sound pressure level is measured on the rated condition in the anechoic rooms by ISO 3745 Standard. Therefore, these values can be increased owing to ambient conditions during operation.

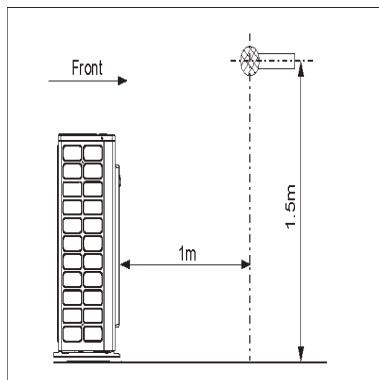

3. ATUW24GPLP1 + ATNW24GPLP1

3.1 Specifications

Category		Unit	Specification
Major	Minor		
Classification	Chassis	-	U24A
	Cooling / Heating	-	H/P
Power Supply	Case 1	-	220, 1, 60
	Case 2	-	-
	Limit Range of Voltage(Case 1)	V	198~242
	Limit Range of Voltage(Case 2)	V	-
Cooling Capacity	Rated	kW	7.03
		Btu/h	24,000
	Min ~ Max	kW	2.80~8.20
		Btu/h	9,600~28,000
	Sensible	kW	5.98
		Btu/h	20,400
Heating Capacity	Rated	kW	7.62
		Btu/h	26,000
	Min ~ Max	kW	2.80~8.60
		Btu/h	9,600~28,000
Power Input(Cooling)	Rated	kW	2.17
	Min ~ Max	kW	~-~
Power Input(Heating)	Rated	kW	2.24
	Min ~ Max	kW	~-~
Efficiency	EER	W/W	3.24
	COP	W/W	3.41
	SEER	Wh/Wh	6.70
Running Current(Cooling)	Rated	A	9.90
	Min/Max	A	- / -
Running Current(Heating)	Rated	A	10.20
	Min/Max	A	- / -
Running Current	Max	A	19.00
Power Factor(Cooling/Heating)	Rated	-	0.99 / 0.99
Outdoor Fan	Type	-	Propeller
	Air Flow Rate(Max)	m ³ /min x No.	50 x 1
	Max. External Static Pressure	Pa	-
Outdoor Fan Motor	Type	-	BLDC
	Drive	-	-
	Output	W x No.	85 x 1
Compressor	Type	-	Twin Rotary
	Model x No.	-	GKT208MAB x 1
	Motor Type	-	BLDC
	Motor Output	W x No.	1,500 x 1
	Oil Type	-	PVE
	Oil Charging amount	cc x No.	670 x 1
Heat Exchanger	Rows x Columns x FPI	-	2 x 28 x 14
	No.	-	1
	Fin Type	-	Wide Louver Plus
	Corrosion Protection (Coating)	-	-
	Material (Tube / Fin)	-	-
	Face Area	m ²	-
Dimensions	Net(W x H x D)	mm	870 x 650 x 330
	Shipping(W x H x D)	mm	1,026 x 693 x 446
Weight	Net	kg	44.7

3. ATUW24GPLP1 + ATNW24GPLP1

Category		Unit	Specification
Major	Minor		
Weight	Shipping	kg	48.3
Exterior	Color	-	Warm Gray
	RAL (Classic)	-	RAL 7044
Protection Device	High Pressure Prevention	-	-
	Frost Prevention	-	-
	Discharge Temperature Control	-	-
	Inverter Protection	-	-
Refrigerant	Type	-	R410A
	Precharged Amount	kg	1.600
	Additional Charging amount	g/m	40
	GWP(Global Warming Potential)	-	2,087.5
	t-CO ₂ eq.	-	3.340
	Chargeless-Pipe Length	m	7.5
	Control Type	-	EEV
Connecting Pipe	Liquid	mm(inch)	Φ9.52 (3/8)
	Gas	mm(inch)	Φ15.88 (5/8)
Pipe Connecting Socket	Liquid	mm(inch)	Φ9.52 (3/8)
	Gas	mm(inch)	Φ15.88 (5/8)
	Connection Type(Liquid)	-	Flare
	Connection Type(Gas)	-	Flare
Piping Length Limit	IDU - ODU(Rated / Max / Min)	m	5 / 50 / 5
Maximum Height Difference	IDU - ODU(Max)	m	30
Sound Pressure Level (Outdoor Unit)	Cooling / Heating (@ 1.5m height)	dB(A)	52.0 / 52.0
Measurement Standard (Pressure Level)	-	-	ISO 3745
Sound Power Level (Outdoor Unit)	Cooling / Heating	dB(A)	-
Measurement Standard (Power Level)	-	-	-
Connecting Cable	Power Supply Cable(H07RN-F)	mm ² × cores	2.5 x 3C
Electrical Characteristic	Minimum Circuit Amperes (MCA)	A	22.4
	Maximum Fuse Amperes (MFA)	A	25
	Comp_Rated Load Amperes (Max)	A	12.0
	Outdoor Fan Motor_Full Load Amperes (FLA)	A	0.33

Note

- Due to our policy of innovation some specifications may be changed without notification.
- Wiring cable size must comply with the applicable local and national codes. And "Electric characteristics" should be considered for electrical work and design. Especially the power cable and circuit breaker should be selected in accordance with that.
- Power factor could vary less than ±1% according to the operating conditions.
- Sound level values are depend on the ambient conditions and values are normally higher in actual operation.
- This product contains Fluorinated greenhouse gases.
- Voltage supplied to the unit terminals should be within the minimum and maximum range.
- Maximum allowable voltage unbalance between phase is 2%.
- MSC means the Max. current during the starting of compressor.
- MSC and RLA are measured as the compressor only test condition.
- OFM and IFM are measured as the outdoor unit test condition.
- Select the wire size based on MCA.
- MFA is used to select the circuit breaker and ground fault circuit interrupter, and all installation site must require attachment of an earth leakage breaker. [circuit breaker type is ELCB(Earth Leakage Circuit Breaker)].
- Performances are based on the following conditions :
 - Cooling : Indoor Ambient Temp. 27°CDB / 19°CWB, Outdoor Ambient Temp. 35°CDB / 24°CWB
 - Heating : Indoor Ambient Temp. 20°CDB / 15°CWB, Outdoor Ambient Temp. 7°CDB / 6°CWB
 - Interconnected Pipe Length is standard length and difference of Elevation (Outdoor ~ Indoor Unit) is 0m.

3. ATUW24GPLP1 + ATNW24GPLP1

3.2 List of Functions

Category	Functions	Availability
Reliability	Defrost / Deicing	O
	High Pressure Switch	X
	Low Pressure Switch	X
	Phase Protection	X
	Restart Delay (3-minutes)	O
	Self Diagnosis	O
	Soft Start	O
Convenience	Night Low Noise Operation	O
	Wiring Error Check	X
	Peak Control	O
	Mode Lock	O
	Forced Cooling Operation (Outdoor Unit)	X
	Advanced SLC (Smart Load Control)	X
Special Functions	ODU Dry Contact Function	X

Note

- O : Applied, X : Not applied
- Accessory : Ordered and purchased separately the accessory package referring to the model name provided and install at field.
- Accessory line-ups varies by region, so check your local catalogue or local sales material.

3. ATUW24GPLP1 + ATNW24GPLP1

3.3 Accessory Compatibility List

Category	Accessory Name	Model Name	Description	Compatibility
Central Controller	AC EZ	PQCSZ250S0	-	O
	AC EZ touch	PACEZA000	Touch type	O
	AC Smart IV	PACS4B000	Touch type	O
	AC Smart 5	PACS5A000	Touch type	O
	ACP IV	PACP4B000	-	O
	ACP 5	PACP5A000	-	O
	AC Manager IV	PACM4B000	For Integrated Control	O
	AC Manager 5	PACM5A000	For Integrated Control	O
Gateway	ODU PI485	PMNFP14A1	For 16-room (3 series)	O
	ACP BACnet	PQNFB17C0	-	O
	ACP Lonwork	PLNWKB000	-	O
	Cloud Gateway	PWFMDB200	-	O
Integration Device	AHU comm. kit	PAHCMR000	For AHU Control (Multi V / Single ODU Communication)	O
		PAHCMS000	For AHU Control (Multi V / Single ODU Communication)	X
	AHU Controller Module	PAHCMC000	For AHU Control (Communication Module)	X
		PAHCMM000	For AHU Control (Main Module)	X
	PDI Standard	PPWRDB000	Power distributor 2port	X
	PDI Premium	PQNUD1S40	Power distributor 8port	X

Note

- O: Possible, X: Impossible, -: Unconfirmed or irrelevant
- AC Manager requires ACP or AC Smart.
- Compatibility of individual controller(wireless/wired remote controller) could be found with function list on Indoor Unit's PDB.
- If you need more detail, please refer to the Control(BECON) PDB or the manual of product.
(<http://partner.lge.com/global> : Home> Doc.Library> Product > Control(BECON)).
- Accessory line-ups varies by region, so check your local catalogue or local sales material.

3. ATUW24GPLP1 + ATNW24GPLP1

3.4 Dimensions

3.4.1 Product

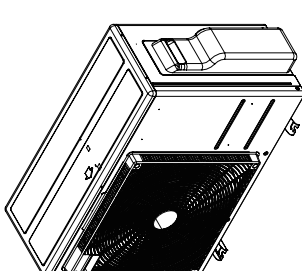

3D View

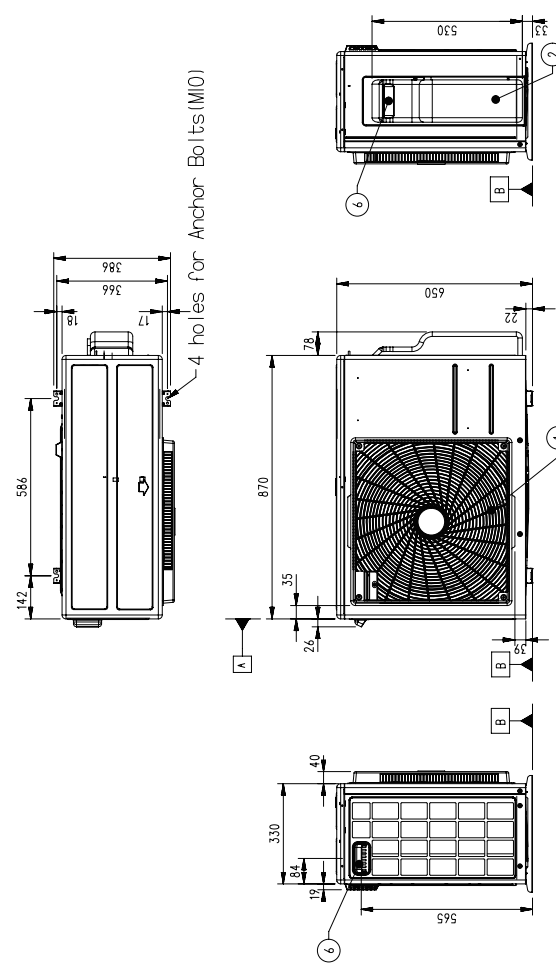

4 holes for Anchor Bolts (M10)

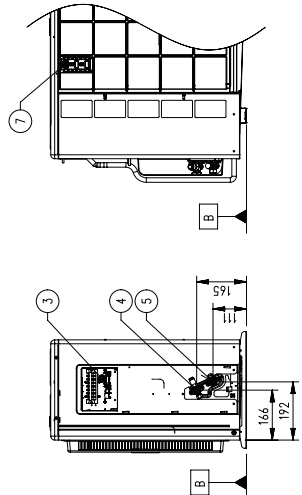

Side View
(removed valve cover)

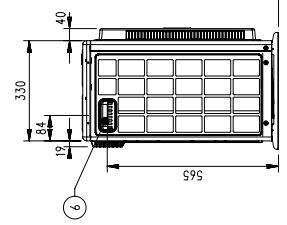
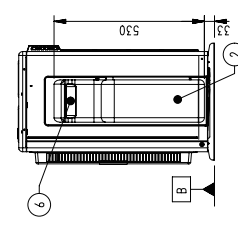
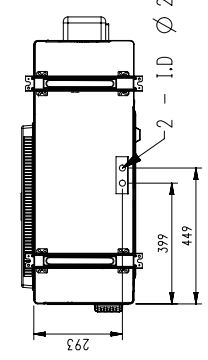
2 - I.D Ø 20 Holes for drain connection

[Unit: mm]

Chassis code : U24A
DWG No. : TBW35646501_Rev01

No.	Part Name	Description
7	Intake air temperature sensor cover	-
6	Handle	-
5	Liquid Pipe connection	-
4	Gas Pipe Connection	-
3	Power and communication cable connection	-
2	Control cover & SVC valve cover	-
1	Air Outlet	-

1. Unit should be installed in compliance with the installation manual in the product box
2. Unit should be grounded in accordance with the local regulations or applicable national codes
3. All electrical components and materials to be supplied from the site must comply with the local regulations or international codes
4. Electrical characteristics chapter should be considered for electrical work and design. Especially the power cable and circuit breaker should be selected in accordance with that

3. ATUW24GPLP1 + ATNW24GPLP1

3.4.2 Install Space

For Side Discharge (capacity < 28.0 kW)

Obstacle on the Suction side

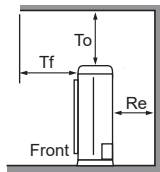

To ≥ 1,000(39-3/8)
Tf ≤ 500(19-11/16)

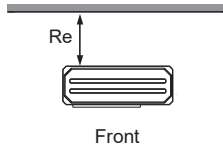

Case 1
Re ≥ 100(3-15/16)
Case 2
Re ≥ 300(11-13/16)

※ Case 1 : No obstacle on top side
Case 2 : Obstacle on top side

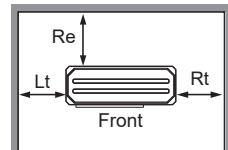

Case 1
Re ≥ 100(3-15/16)
Lt ≥ 100(3-15/16)
Rt ≥ 100(3-15/16)
Case 2
Re ≥ 300(11-13/16)
Lt ≥ 150(5-29/32)
Rt ≥ 150(5-29/32)

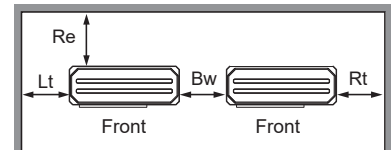

Case 1
Re ≥ 300(11-13/16)
Lt ≥ 1,000(39-3/8)
Rt ≥ 200(7-7/8)
Bw ≥ 100(3-15/16)
Case 2
Re ≥ 300(11-13/16)
Lt ≥ 1,000(39-3/8)
Rt ≥ 200(7-7/8)
Bw ≥ 100(3-15/16)

[Unit : mm(inch)]

Obstacle on the Discharge side

※ For Rear Piping / External SVC Valve type / Side-CBOX type
: Re, Lt ≥ 300(11-13/16) and Rt, Bw, Rb ≥ 600(23-5/8) for ALL CASE.

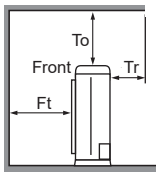
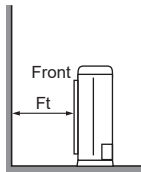

To ≥ 1,000(39-3/8)
Tr ≤ 500(19-11/16)

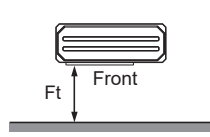

Case 1
Ft ≥ 500(19-11/16)
Case 2
Ft ≥ 500(19-11/16)

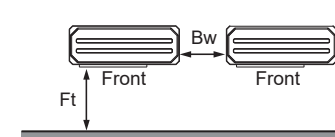

Case 1
Ft ≥ 1,000(39-3/8)
Bw ≥ 100(3-15/16)
Case 2
Ft ≥ 1,000(39-3/8)
Bw ≥ 100(3-15/16)

Obstacle on the Suction and Discharge side

Ld > H (Ls should be lower H.)

※ Close the bottom of the installation frame to prevent the discharged air from being bypassed

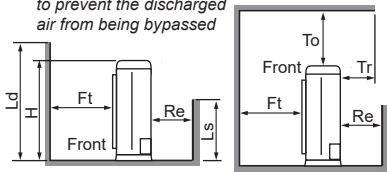

To ≥ 1,000(39-3/8)
Tf ≤ 500(19-11/16)

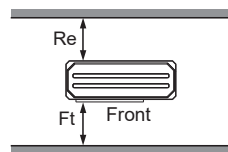

Case 1
Ft ≥ 500(19-11/16)
Re ≥ 300(11-13/16)
Case 2
Ft ≥ 1,000(39-3/8) *
Re ≥ 300(11-13/16)
* If Ls ≤ H/2,
Ft ≥ 750(29-17/32)

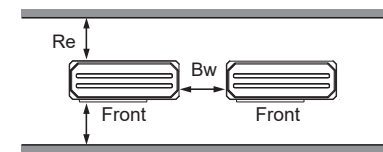

Case 1
Ft ≥ 1,000(39-3/8)
Re ≥ 300(11-13/16)
Bw ≥ 100(3-15/16)
Case 2
Ft ≥ 1,250(49-7/32)
Re ≥ 300(11-13/16)
Bw ≥ 100(3-15/16)

Ld ≤ H

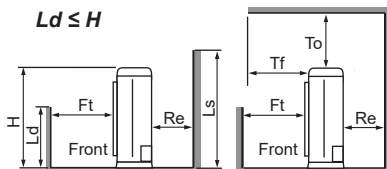

To ≥ 1,000(39-3/8)
Tf ≤ 500(19-11/16)

Case 1
Ft ≥ 500(19-11/16)
Re ≥ 300(11-13/16)
Case 2
Ft ≥ 1,000(39-3/8)
Re ≥ 300(11-13/16)

Case 1
Ft ≥ 1,500(59-1/16)
Re ≥ 300(11-13/16)
Bw ≥ 100(3-15/16)
Case 2
Ft ≥ 1,500(59-1/16)
Re ≥ 300(11-13/16)
Bw ≥ 100(3-15/16)

※ In case of series installation (2 Units or more) for 2 Fan models, Ld should be lower than H/2.

Collective/Continuous Installation (Multiple Columns)

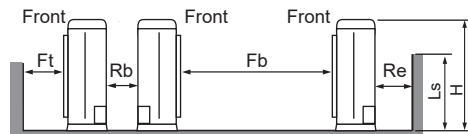

※ In case of Multiple columns/continuous installation, Ls should be lower than H.

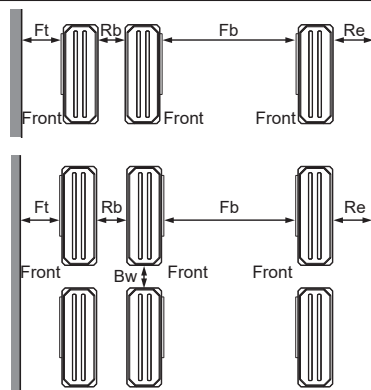

1 Column

Ft ≥ 1,000(39-3/8)
Rb ≥ 200(7-7/8)
Fb ≥ 2,000(78-3/4)
Re ≥ 100(3-15/16)

Multiple Columns

Ft ≥ 1,500(59-1/16)
Rb ≥ 600(23-5/8)
Fb ≥ 3,000(118-1/8)
Re ≥ 300(11-13/16)
Bw ≥ 100(3-15/16)

Note

- If there is a concern about product performance degradation due to group installation or interference with obstacles, secure an additional separation distance.
- Secure enough space for smooth service and maintenance.
- According to product type, model line up, sales region..etc, applicability of each chassis could be different.

3. ATUW24GPLP1 + ATNW24GPLP1

3.5 Piping Diagrams

3.5.1 Normal

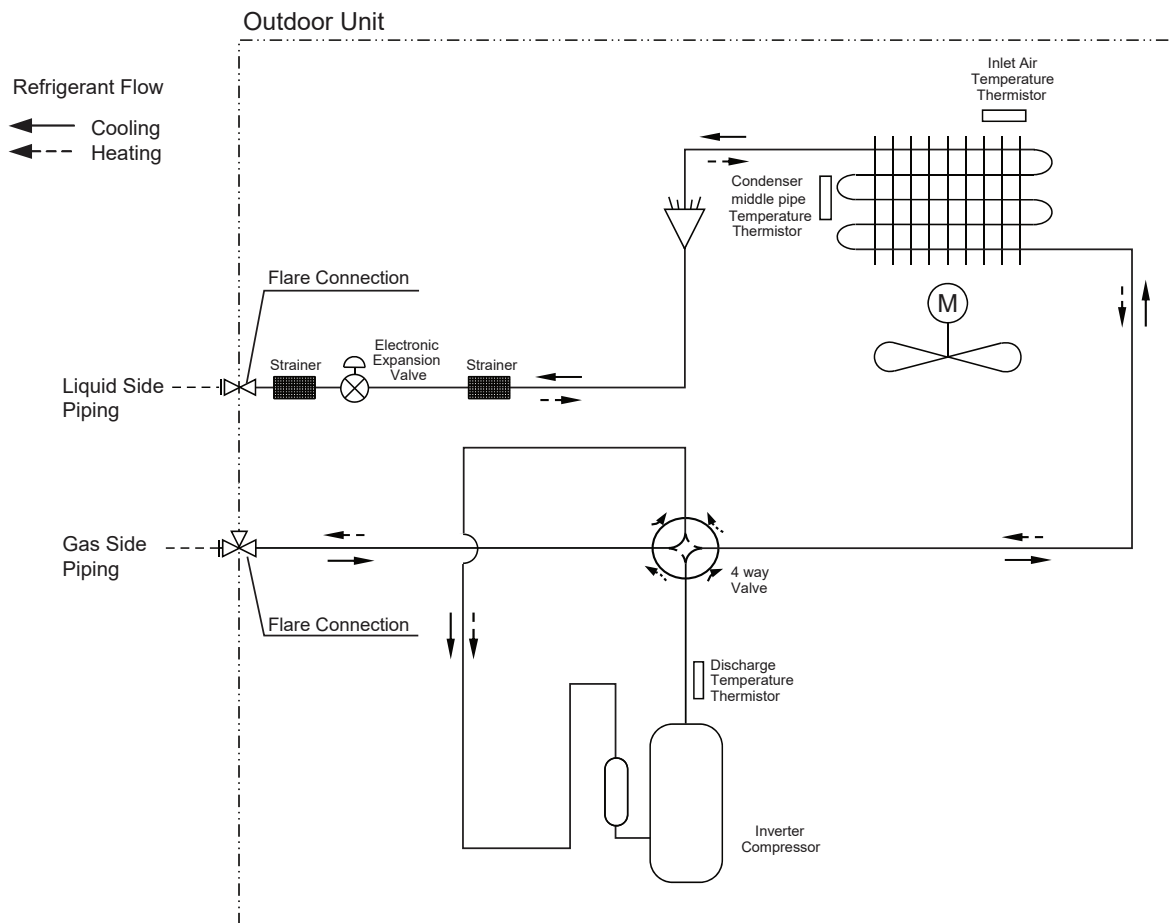

3. ATUW24GPLP1 + ATNW24GPLP1

3.6 Wiring Diagrams

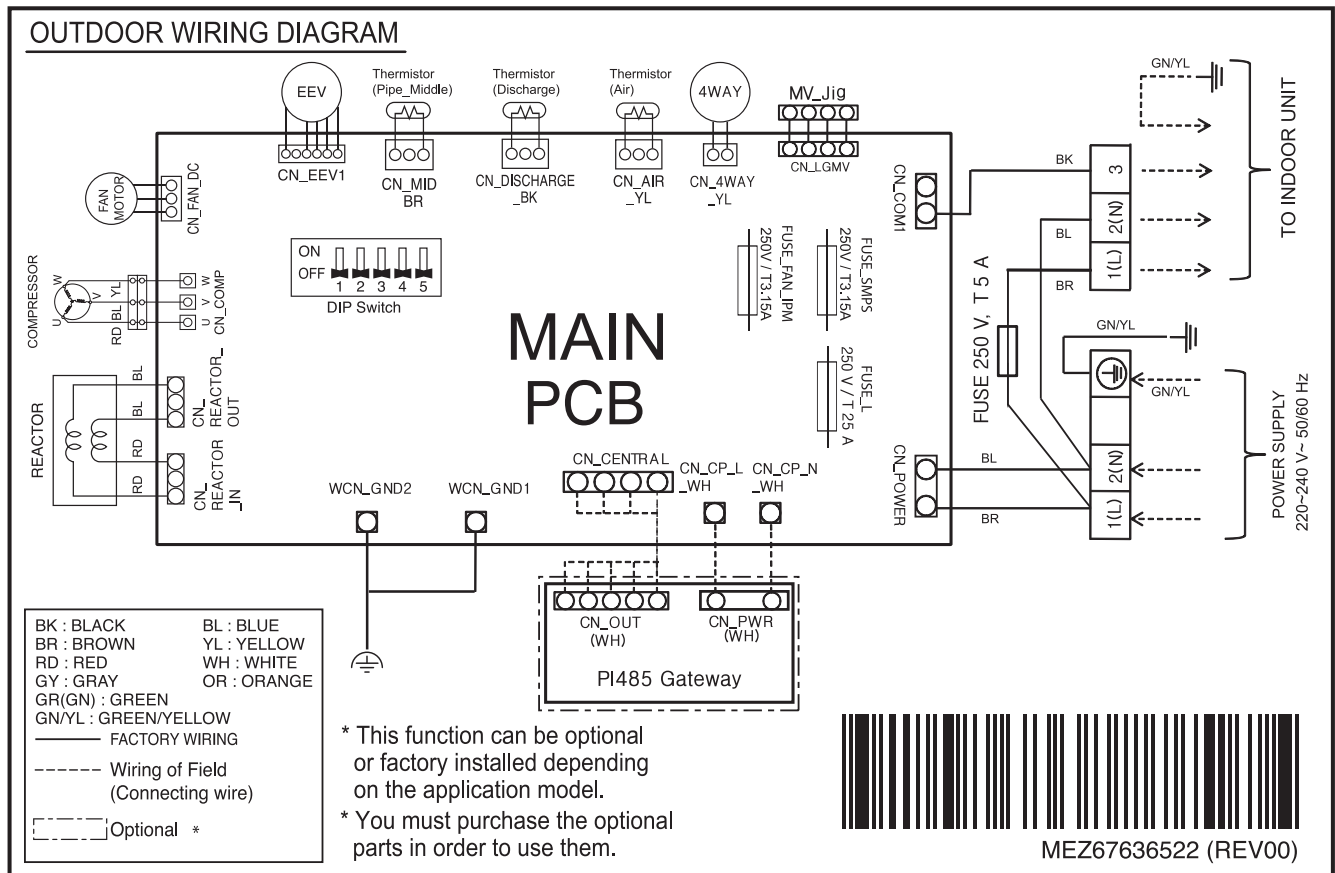

3. ATUW24GPLP1 + ATNW24GPLP1

3.7 Capacity Tables

3.7.1 Cooling

Outdoor Air Temp. (°C, DB)	Indoor Air Temp. (°C, DB/WB)																				
	20.0 / 14.0			22.0 / 16.0			25.0 / 18.0			27.0 / 19.0			28.0 / 20.0			30.0 / 22.0			32.0 / 24.0		
	TC	SHC	PI	TC	SHC	PI	TC	SHC	PI	TC	SHC	PI	TC	SHC	PI	TC	SHC	PI	TC	SHC	PI
20	4.13	4.03	0.88	5.37	4.81	1.11	6.31	5.59	1.28	7.03	5.98	1.41	7.27	5.94	1.42	7.75	5.87	1.45	8.29	5.79	1.46
25	4.13	4.03	1.04	5.37	4.81	1.31	6.31	5.59	1.52	7.03	5.98	1.66	7.27	5.94	1.68	7.75	5.87	1.71	8.29	5.79	1.72
32	4.13	4.03	1.26	5.37	4.81	1.59	6.31	5.59	1.84	7.03	5.98	2.02	7.27	5.94	2.04	7.75	5.87	2.08	8.29	5.79	2.09
35	4.13	4.03	1.36	5.37	4.81	1.71	6.31	5.59	1.98	7.03	5.98	2.17	7.27	5.94	2.19	7.75	5.87	2.24	8.29	5.79	2.25
40	4.13	4.03	1.62	5.37	4.81	2.04	6.31	5.59	2.36	7.03	5.98	2.59	7.27	5.94	2.62	7.75	5.87	2.67	8.29	5.79	2.69
43	4.13	4.03	1.78	5.37	4.81	2.24	6.31	5.59	2.59	7.03	5.98	2.85	7.27	5.94	2.88	7.75	5.87	2.93	8.29	5.79	2.95
46	4.13	4.03	1.96	5.37	4.81	2.46	6.31	5.59	2.71	6.40	5.50	2.77	6.62	5.46	2.80	7.05	5.39	2.85	7.55	5.31	2.87
48	4.13	4.03	2.15	5.37	4.81	2.51	5.91	5.28	2.56	6.03	5.23	2.61	6.20	5.16	2.64	6.55	5.03	2.69	6.94	4.90	2.71
50	4.13	4.03	2.31	5.37	4.81	2.36	5.55	4.95	2.41	5.66	4.94	2.46	5.79	4.85	2.48	6.04	4.66	2.53	6.34	4.49	2.55
52	4.13	4.03	2.17	5.08	4.60	2.21	5.19	4.67	2.26	5.29	4.65	2.30	5.37	4.53	2.32	5.53	4.29	2.37	5.73	4.08	2.39
54	4.13	4.03	2.02	4.73	4.33	2.06	4.82	4.40	2.11	4.92	4.36	2.15	4.95	4.21	2.17	5.02	3.92	2.21	5.12	3.66	2.23

Note

- DB : Dry bulb temperature(°C), WB : Wet bulb temperature(°C)
- TC : Total Capacity(kW), SHC : Sensible Heat Capacity(kW)
- PI : Power Input (kW, Compressor + indoor fan motor + outdoor fan motor)
- All capacities are net. A deduction of capacity due to operating heat of indoor unit motor is reflected.
- Direct interpolation is permissible. Do not extrapolate.
- Rated capacities and power inputs are based on standard temperature and piping conditions, and it can be found on specifications table.
Except for rated value, the performance is not guaranteed.
- In accordance with the test standard(or nations), the rating will vary slightly.

3. ATUW24GPLP1 + ATNW24GPLP1

3.7.2 Heating

Outdoor Air Temp. (°C, WB)	Indoor Air Temp. (°C, DB)									
	16.0		18.0		20.0		22.0		24.0	
	TC	PI	TC	PI	TC	PI	TC	PI	TC	PI
-5.0	6.93	1.94	6.90	2.13	6.86	2.31	6.82	2.50	6.79	2.69
0.0	7.70	2.31	7.66	2.50	7.62	2.69	7.32	2.54	7.01	2.38
6.0	8.44	2.46	8.03	2.35	7.62	2.24	7.32	2.13	7.01	2.02
10.0	8.44	2.31	8.03	2.13	7.62	1.94	7.32	1.86	7.01	1.77
15.0	8.44	1.94	8.03	1.75	7.62	1.57	7.32	1.52	7.01	1.47
18.0	8.44	1.72	8.03	1.53	7.62	1.34	7.32	1.31	7.01	1.28

Note

- DB : Dry bulb temperature(°C), WB : Wet bulb temperature(°C)
- TC : Total Capacity(kW)
- PI : Power Input (kW, Compressor + indoor fan motor + outdoor fan motor)
- All capacities are net. An addition of capacity due to operating heat of indoor unit motor is reflected.
- Direct interpolation is permissible. Do not extrapolate.
- Rated capacities and power inputs are based on standard temperature and piping conditions, and it can be found on specifications table.
Except for rated value, the performance is not guaranteed.
- In accordance with the test standard(or nations), the rating will vary slightly.

3. ATUW24GPLP1 + ATNW24GPLP1

3.8 Capacity Correction Factor

Operation	Capacity correction factor (%) by Equivalent pipe length (m)										
	5	7.5	10	15	20	25	30	35	40	45	50
Cooling	100.0	99.9	99.8	99.3	98.8	98.3	97.8	94.4	91.1	89.8	88.4
Heating	100.0	99.9	99.8	99.4	99.0	98.6	98.3	97.4	96.6	96.1	95.6

Note

In Order to estimate the actual system capacity, the influence of various installation conditions should be reflected.

Reflect the capacity correction factor effect of piping installation as below.

- Qodu [from specification table] : Outdoor unit standard capacity.
- Q(Ti, To) [from capacity table] : Outdoor unit capacity at Ti, To temperature.
- F(Ti, To) = Q(Ti, To) / Qodu. : Outdoor unit capacity correction factor
- Fpiping for piping length [from capacity correction factor table] : Piping correction factor
- Indoor unit actual capacity : Qactual = Qodu x F(Ti, To) x Fpiping

3. ATUW24GPLP1 + ATNW24GPLP1

3.9 Operation Limits

3.9.1 Cooling

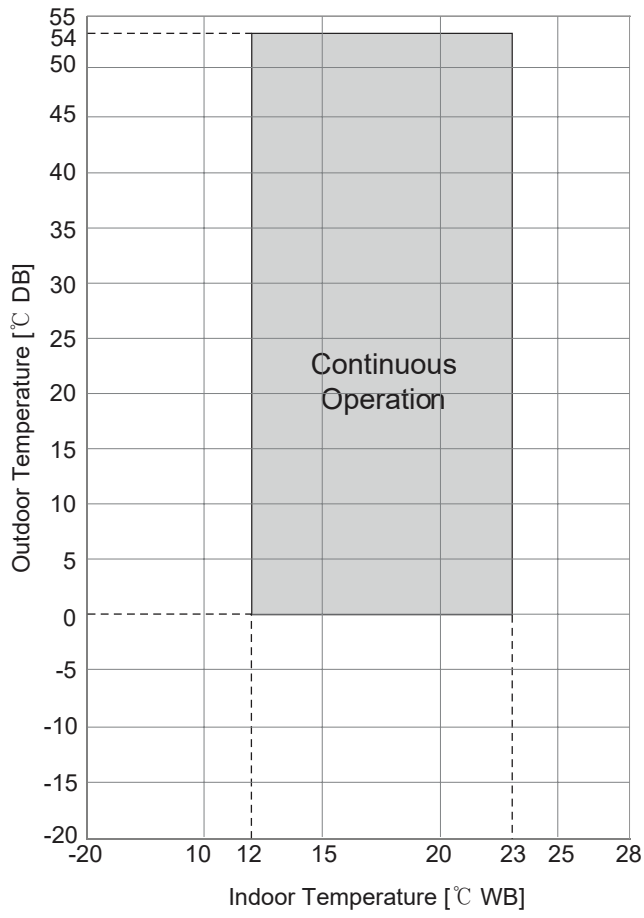

3. ATUW24GPLP1 + ATNW24GPLP1

3.9.2 Heating

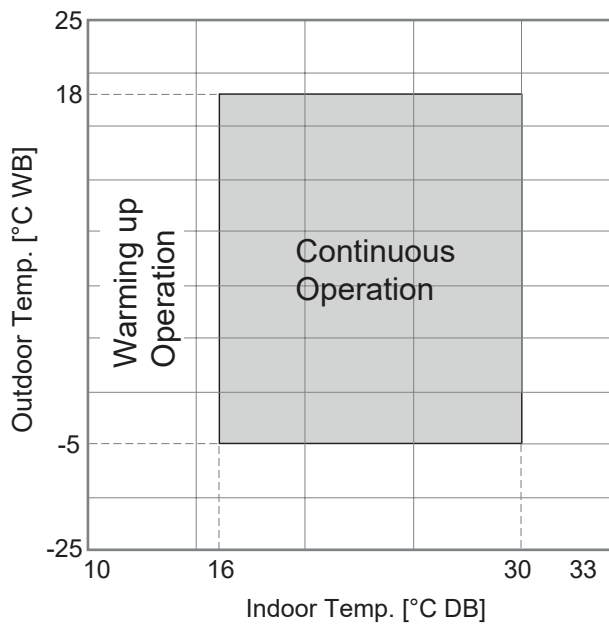
**Note**

- Warming up operation and operative mean that the outdoor unit operates to reach the range of continuous operating, however it may not operate continuously due to safety or protection logic.

3. ATUW24GPLP1 + ATNW24GPLP1

3.10 Sound Levels

3.10.1 Pressure Levels

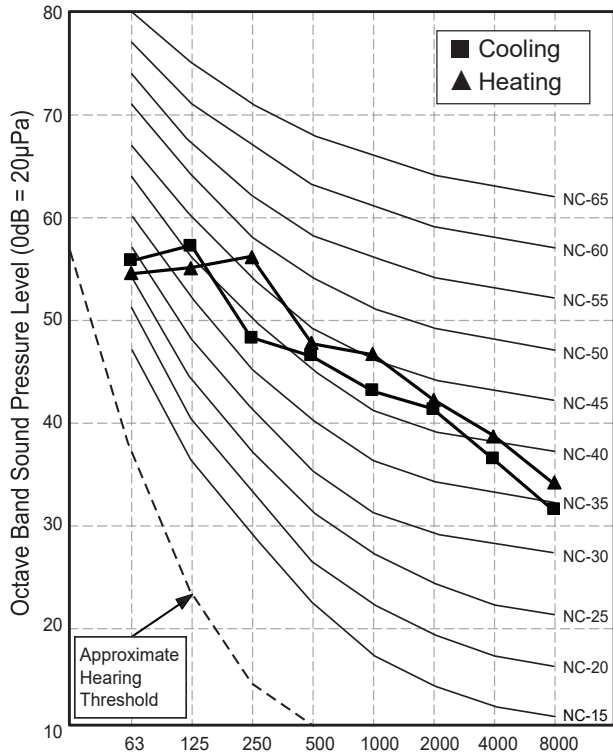

Sound level [dB(A), @ Standard condition]	
Cooling / Heating (@ 1.5m height)	52.0 / 52.0

Note

- Data is valid at diffuse field condition.
- Data is valid at nominal operating condition. Refer to the model specifications for nominal conditions.(Power source and Ambient temperature, etc)
- Reference acoustic pressure 0dB = 20µPa.
- Sound levels can be increased in accordance with installation and operating conditions. (Operating conditions include some functional condition like Static pressure mode, air guide use, Room target temperature setting, etc and these functions are different in accordance with each model.)
- Sound level will vary depending on a range of factors such as the construction(acoustic absorption coefficient) of particular room in which the equipment in installed.
- Sound pressure level is measured on the rated condition in the anechoic rooms by ISO 3745 Standard. Therefore, these values can be increased owing to ambient conditions during operation.

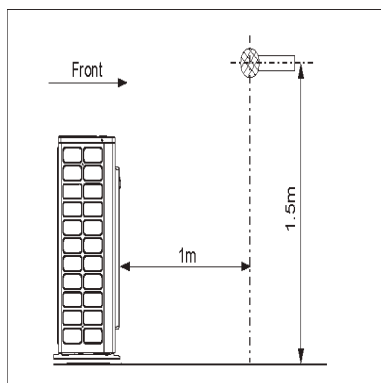

4. ATUW24GTLP1 + ATNW24GTLP1

4.1 Specifications

Category		Unit	Specification
Major	Minor		
Classification	Chassis	-	U24A
	Cooling / Heating	-	H/P
Power Supply	Case 1	-	220, 1, 60
	Case 2	-	-
	Limit Range of Voltage(Case 1)	V	198~242
	Limit Range of Voltage(Case 2)	V	-
Cooling Capacity	Rated	kW	6.16
		Btu/h	21,000
	Min ~ Max	kW	1.98~7.60
		Btu/h	6,750~25,930
	Sensible	kW	4.37
		Btu/h	14,910
Heating Capacity	Rated	kW	6.74
		Btu/h	23,000
	Min ~ Max	kW	2.43~7.30
		Btu/h	8,300~25,000
Power Input(Cooling)	Rated	kW	2.04
	Min ~ Max	kW	~
Power Input(Heating)	Rated	kW	2.28
	Min ~ Max	kW	~
Efficiency	EER	W/W	3.02
	COP	W/W	2.96
	SEER	Wh/Wh	5.75
Running Current(Cooling)	Rated	A	9.30
	Min/Max	A	- / -
Running Current(Heating)	Rated	A	10.40
	Min/Max	A	- / -
Running Current	Max	A	19.00
Power Factor(Cooling/Heating)	Rated	-	0.99 / 0.99
Outdoor Fan	Type	-	Propeller
	Air Flow Rate(Max)	m ³ /min x No.	50 x 1
	Max. External Static Pressure	Pa	-
Outdoor Fan Motor	Type	-	BLDC
	Drive	-	-
	Output	W x No.	85 x 1
Compressor	Type	-	Twin Rotary
	Model x No.	-	GKT208MAB x 1
	Motor Type	-	BLDC
	Motor Output	W x No.	1,500 x 1
	Oil Type	-	PVE
	Oil Charging amount	cc x No.	670 x 1
Heat Exchanger	Rows x Columns x FPI	-	2 x 28 x 14
	No.	-	1
	Fin Type	-	Wide Louver Plus
	Corrosion Protection (Coating)	-	-
	Material (Tube / Fin)	-	-
	Face Area	m ²	-
Dimensions	Net(W x H x D)	mm	870 x 650 x 330
	Shipping(W x H x D)	mm	1,026 x 693 x 446
Weight	Net	kg	44.7

4. ATUW24GTLP1 + ATNW24GTLP1

Category		Unit	Specification
Major	Minor		
Weight	Shipping	kg	48.3
Exterior	Color	-	Warm Gray
	RAL (Classic)	-	RAL 7044
Protection Device	High Pressure Prevention	-	-
	Frost Prevention	-	-
	Discharge Temperature Control	-	-
	Inverter Protection	-	-
Refrigerant	Type	-	R410A
	Precharged Amount	kg	1.600
	Additional Charging amount	g/m	40
	GWP(Global Warming Potential)	-	2,087.5
	t-CO ₂ eq.	-	3.340
	Chargeless-Pipe Length	m	7.5
	Control Type	-	EEV
Connecting Pipe	Liquid	mm(inch)	Φ9.52 (3/8)
	Gas	mm(inch)	Φ15.88 (5/8)
Pipe Connecting Socket	Liquid	mm(inch)	Φ9.52 (3/8)
	Gas	mm(inch)	Φ15.88 (5/8)
	Connection Type(Liquid)	-	Flare
	Connection Type(Gas)	-	Flare
Piping Length Limit	IDU - ODU(Rated / Max / Min)	m	5 / 50 / 5
Maximum Height Difference	IDU - ODU(Max)	m	30
Sound Pressure Level (Outdoor Unit)	Cooling / Heating (@ 1.5m height)	dB(A)	50.0 / 52.0
Measurement Standard (Pressure Level)	-	-	ISO 3745
Sound Power Level (Outdoor Unit)	Cooling / Heating	dB(A)	-
Measurement Standard (Power Level)	-	-	-
Connecting Cable	Power Supply Cable(H07RN-F)	mm ² × cores	2.5 x 3C
Electrical Characteristic	Minimum Circuit Amperes (MCA)	A	22.4
	Maximum Fuse Amperes (MFA)	A	25
	Comp_Rated Load Amperes (Max)	A	12.0
	Outdoor Fan Motor_Full Load Amperes (FLA)	A	0.33

Note

- Due to our policy of innovation some specifications may be changed without notification.
- Wiring cable size must comply with the applicable local and national codes. And "Electric characteristics" should be considered for electrical work and design. Especially the power cable and circuit breaker should be selected in accordance with that.
- Power factor could vary less than ±1% according to the operating conditions.
- Sound level values are depend on the ambient conditions and values are normally higher in actual operation.
- This product contains Fluorinated greenhouse gases.
- Voltage supplied to the unit terminals should be within the minimum and maximum range.
- Maximum allowable voltage unbalance between phase is 2%.
- MSC means the Max. current during the starting of compressor.
- MSC and RLA are measured as the compressor only test condition.
- OFM and IFM are measured as the outdoor unit test condition.
- Select the wire size based on MCA.
- MFA is used to select the circuit breaker and ground fault circuit interrupter, and all installation site must require attachment of an earth leakage breaker. [circuit breaker type is ELCB(Earth Leakage Circuit Breaker)].
- Performances are based on the following conditions :
 - Cooling : Indoor Ambient Temp. 27°CDB / 19°CWB, Outdoor Ambient Temp. 35°CDB / 24°CWB
 - Heating : Indoor Ambient Temp. 20°CDB / 15°CWB, Outdoor Ambient Temp. 7°CDB / 6°CWB
 - Interconnected Pipe Length is standard length and difference of Elevation (Outdoor ~ Indoor Unit) is 0m.

4. ATUW24GTLP1 + ATNW24GTLP1

4.2 List of Functions

Category	Functions	Availability
Reliability	Defrost / Deicing	O
	High Pressure Switch	X
	Low Pressure Switch	X
	Phase Protection	X
	Restart Delay (3-minutes)	O
	Self Diagnosis	O
	Soft Start	O
Convenience	Night Low Noise Operation	O
	Wiring Error Check	X
	Peak Control	O
	Mode Lock	O
	Forced Cooling Operation (Outdoor Unit)	X
	Advanced SLC (Smart Load Control)	X
Special Functions	ODU Dry Contact Function	X

Note

■ O : Applied, X : Not applied

- Accessory : Ordered and purchased separately the accessory package referring to the model name provided and install at field.

- Accessory line-ups varies by region, so check your local catalogue or local sales material.

4. ATUW24GTLP1 + ATNW24GTLP1

4.3 Accessory Compatibility List

Category	Accessory Name	Model Name	Description	Compatibility
Central Controller	AC EZ	PQCSZ250S0	-	O
	AC EZ touch	PACEZA000	Touch type	O
	AC Smart IV	PACS4B000	Touch type	O
	AC Smart 5	PACS5A000	Touch type	O
	ACP IV	PACP4B000	-	O
	ACP 5	PACP5A000	-	O
	AC Manager IV	PACM4B000	For Integrated Control	O
	AC Manager 5	PACM5A000	For Integrated Control	O
Gateway	ODU PI485	PMNFP14A1	For 16-room (3 series)	O
	ACP BACnet	PQNFB17C0	-	O
	ACP Lonwork	PLNWKB000	-	O
	Cloud Gateway	PWFMDB200	-	O
Integration Device	AHU comm. kit	PAHCMR000	For AHU Control (Multi V / Single ODU Communication)	O
		PAHCMS000	For AHU Control (Multi V / Single ODU Communication)	X
	AHU Controller Module	PAHCMC000	For AHU Control (Communication Module)	X
		PAHCMM000	For AHU Control (Main Module)	X
	PDI Standard	PPWRDB000	Power distributor 2port	X
	PDI Premium	PQNUD1S40	Power distributor 8port	X

Note

- O: Possible, X: Impossible, -: Unconfirmed or irrelevant
- AC Manager requires ACP or AC Smart.
- Compatibility of individual controller(wireless/wired remote controller) could be found with function list on Indoor Unit's PDB.
- If you need more detail, please refer to the Control(BECON) PDB or the manual of product.
(<http://partner.lge.com/global> : Home> Doc.Library> Product > Control(BECON)).
- Accessory line-ups varies by region, so check your local catalogue or local sales material.

4. ATUW24GTLP1 + ATNW24GTLP1

4.4 Dimensions

4.4.1 Product

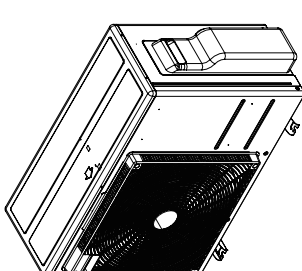

3D View

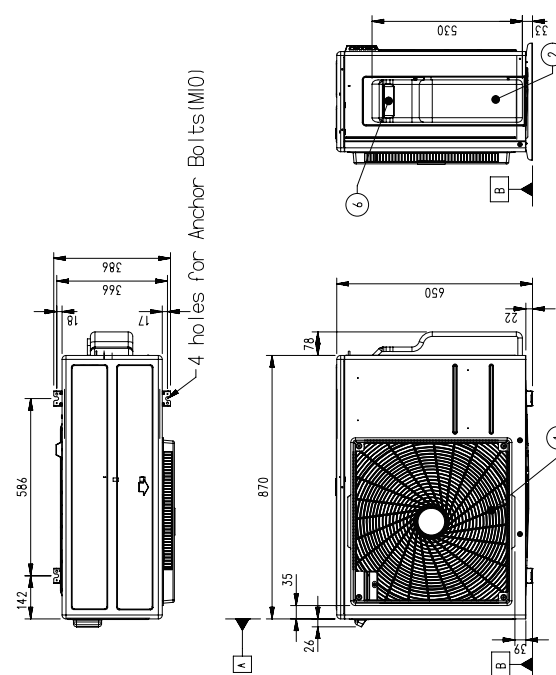

4 holes for Anchor Bolts (M10)

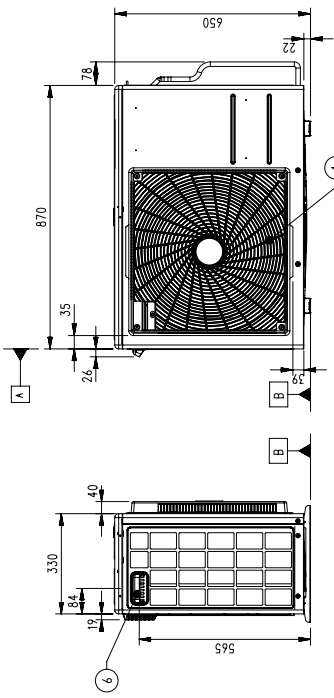
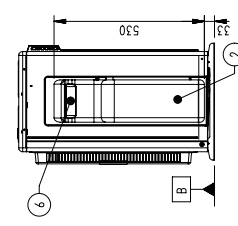
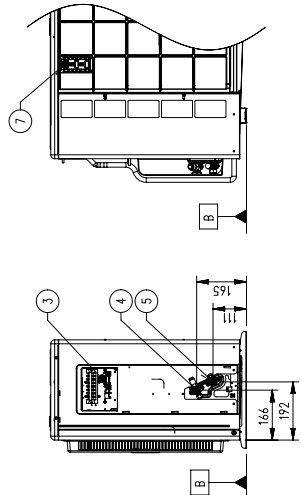
Side View
(removed valve cover)

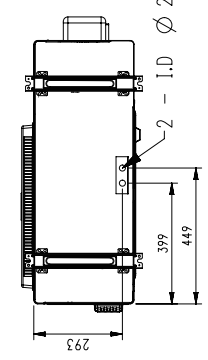

2 - I.D Ø 20 Holes for drain connection

No.	Part Name	Description
7	Intake air temperature sensor cover	-
6	Handle	-
5	Liquid Pipe connection	-
4	Gas Pipe Connection	-
3	Power and communication cable connection	-
2	Control cover & SVC valve cover	-
1	Air Outlet	-

1. Unit should be installed in compliance with the installation manual in the product box

2. Unit should be grounded in accordance with the local regulations or applicable national codes

3. All electrical components and materials to be supplied from the site must comply with the local regulations or international codes

4. Electrical characteristics chapter should be considered for electrical work and design. Especially the power cable and circuit breaker should be selected in accordance with that

[Unit: mm]
 Chassis code : U24A
 DWG No. : TBW35646501_Rev01

4. ATUW24GTLP1 + ATNW24GTLP1

4.4.2 Install Space

For Side Discharge (capacity < 28.0 kW)

Obstacle on the Suction side

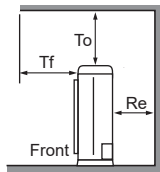

To ≥ 1,000(39-3/8)
Tf ≤ 500(19-11/16)

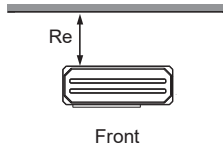

Case 1
Re ≥ 100(3-15/16)
Case 2
Re ≥ 300(11-13/16)

※ Case 1 : No obstacle on top side
Case 2 : Obstacle on top side

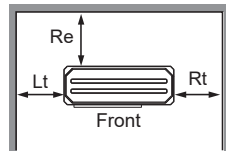

Case 1
Re ≥ 100(3-15/16)
Lt ≥ 100(3-15/16)
Rt ≥ 100(3-15/16)
Case 2
Re ≥ 300(11-13/16)
Lt ≥ 150(5-29/32)
Rt ≥ 150(5-29/32)

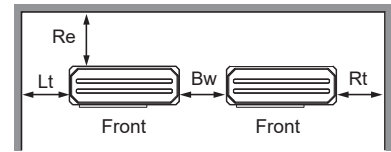

Case 1
Re ≥ 300(11-13/16)
Lt ≥ 1,000(39-3/8)
Rt ≥ 200(7-7/8)
Bw ≥ 100(3-15/16)
Case 2
Re ≥ 300(11-13/16)
Lt ≥ 1,000(39-3/8)
Rt ≥ 200(7-7/8)
Bw ≥ 100(3-15/16)

[Unit : mm(inch)]

Obstacle on the Discharge side

※ For Rear Piping / External SVC Valve type / Side-CBOX type
: Re, Lt ≥ 300(11-13/16) and Rt, Bw, Rb ≥ 600(23-5/8) for ALL CASE.

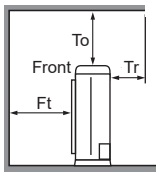
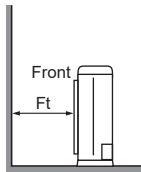

To ≥ 1,000(39-3/8)
Tr ≤ 500(19-11/16)

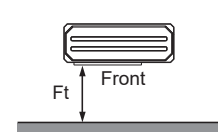

Case 1
Ft ≥ 500(19-11/16)
Case 2
Ft ≥ 500(19-11/16)

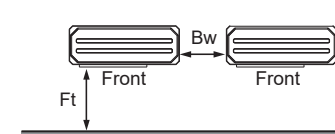

Case 1
Ft ≥ 1,000(39-3/8)
Bw ≥ 100(3-15/16)
Case 2
Ft ≥ 1,000(39-3/8)
Bw ≥ 100(3-15/16)

Obstacle on the Suction and Discharge side

Ld > H (Ls should be lower H.)

※ Close the bottom of the installation frame to prevent the discharged air from being bypassed

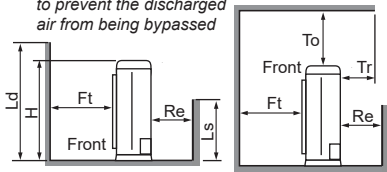

To ≥ 1,000(39-3/8)
Tf ≤ 500(19-11/16)

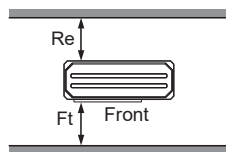

Case 1
Ft ≥ 500(19-11/16)
Re ≥ 300(11-13/16)
Case 2
Ft ≥ 1,000(39-3/8) *
Re ≥ 300(11-13/16)
* If Ls ≤ H/2,
Ft ≥ 750(29-17/32)

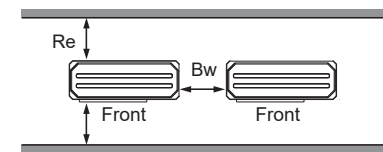

Case 1
Ft ≥ 1,000(39-3/8)
Re ≥ 300(11-13/16)
Bw ≥ 100(3-15/16)
Case 2
Ft ≥ 1,250(49-7/32)
Re ≥ 300(11-13/16)
Bw ≥ 100(3-15/16)

Ld ≤ H

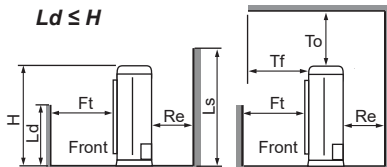

To ≥ 1,000(39-3/8)
Tf ≤ 500(19-11/16)

Case 1
Ft ≥ 500(19-11/16)
Re ≥ 300(11-13/16)
Case 2
Ft ≥ 1,000(39-3/8)
Re ≥ 300(11-13/16)

Case 1
Ft ≥ 1,500(59-1/16)
Re ≥ 300(11-13/16)
Bw ≥ 100(3-15/16)
Case 2
Ft ≥ 1,500(59-1/16)
Re ≥ 300(11-13/16)
Bw ≥ 100(3-15/16)

※ In case of series installation (2 Units or more) for 2 Fan models, Ld should be lower than H/2.

Collective/Continuous Installation (Multiple Columns)

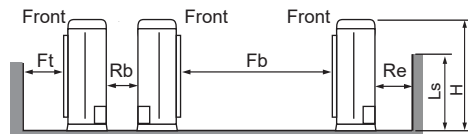

※ In case of Multiple columns/continuous installation, Ls should be lower than H.

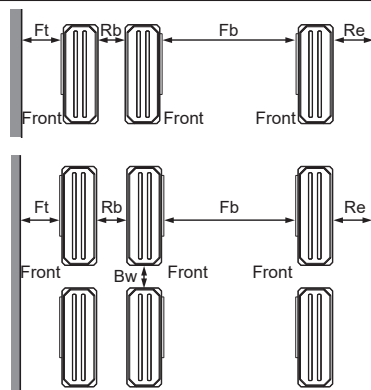

1 Column

Ft ≥ 1,000(39-3/8)
Rb ≥ 200(7-7/8)
Fb ≥ 2,000(78-3/4)
Re ≥ 100(3-15/16)

Multiple Columns

Ft ≥ 1,500(59-1/16)
Rb ≥ 600(23-5/8)
Fb ≥ 3,000(118-1/8)
Re ≥ 300(11-13/16)
Bw ≥ 100(3-15/16)

Note

- If there is a concern about product performance degradation due to group installation or interference with obstacles, secure an additional separation distance.
- Secure enough space for smooth service and maintenance.
- According to product type, model line up, sales region..etc, applicability of each chassis could be different.

4. ATUW24GTLP1 + ATNW24GTLP1

4.5 Piping Diagrams

4.5.1 Normal

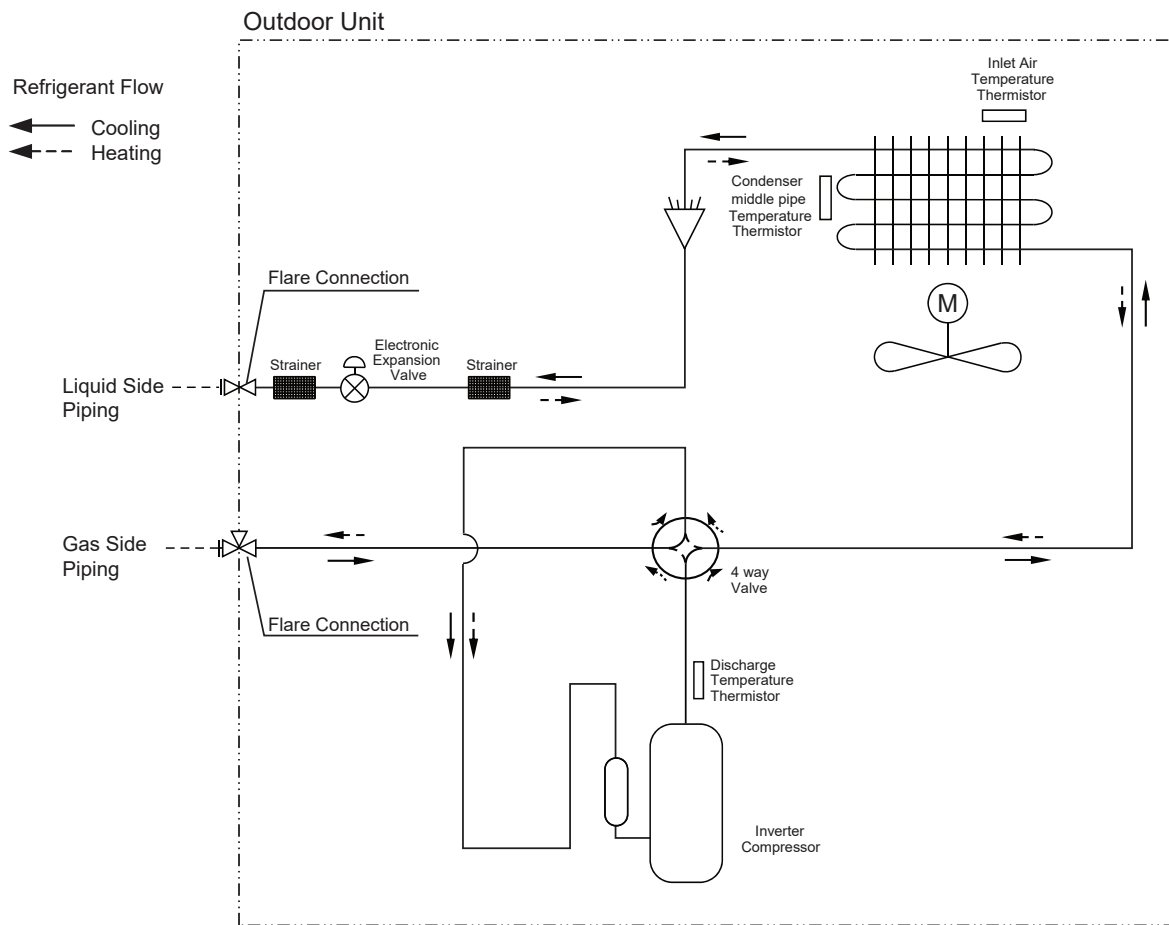

4. ATUW24GTLP1 + ATNW24GTLP1

4.6 Wiring Diagrams

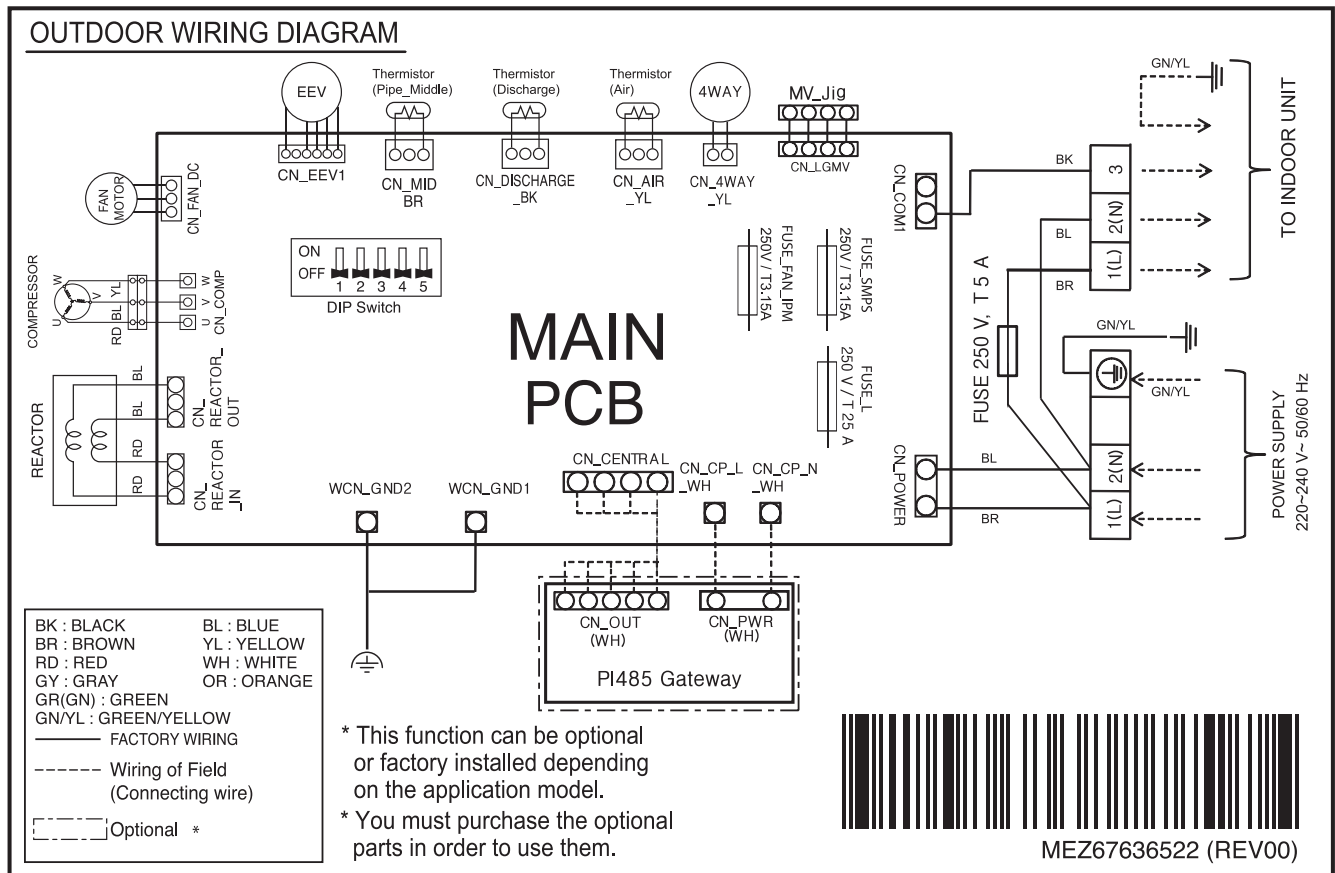

4. ATUW24GTLP1 + ATNW24GTLP1

4.7 Capacity Tables

4.7.1 Cooling

Outdoor Air Temp. (°C, DB)	Indoor Air Temp. (°C, DB/WB)																				
	20.0 / 14.0			22.0 / 16.0			25.0 / 18.0			27.0 / 19.0			28.0 / 20.0			30.0 / 22.0			32.0 / 24.0		
	TC	SHC	PI	TC	SHC	PI	TC	SHC	PI	TC	SHC	PI	TC	SHC	PI	TC	SHC	PI	TC	SHC	PI
20	3.61	2.95	0.83	4.70	3.52	1.04	5.53	4.09	1.21	6.16	4.37	1.32	6.37	4.34	1.33	6.78	4.29	1.36	7.26	4.23	1.37
25	3.61	2.95	0.98	4.70	3.52	1.23	5.53	4.09	1.43	6.16	4.37	1.56	6.37	4.34	1.58	6.78	4.29	1.61	7.26	4.23	1.62
32	3.61	2.95	1.19	4.70	3.52	1.49	5.53	4.09	1.73	6.16	4.37	1.90	6.37	4.34	1.92	6.78	4.29	1.95	7.26	4.23	1.97
35	3.61	2.95	1.28	4.70	3.52	1.61	5.53	4.09	1.86	6.16	4.37	2.04	6.37	4.34	2.06	6.78	4.29	2.10	7.26	4.23	2.11
40	3.61	2.95	1.53	4.70	3.52	1.92	5.53	4.09	2.22	6.16	4.37	2.44	6.37	4.34	2.46	6.78	4.29	2.51	7.26	4.23	2.52
43	3.61	2.95	1.68	4.70	3.52	2.10	5.53	4.09	2.44	6.16	4.37	2.67	6.37	4.34	2.70	6.78	4.29	2.76	7.26	4.23	2.77
46	3.61	2.95	1.84	4.70	3.52	2.31	5.53	4.09	2.54	5.60	4.02	2.60	5.79	3.99	2.62	6.17	3.93	2.67	6.61	3.88	2.69
48	3.61	2.95	2.02	4.70	3.52	2.35	5.17	3.86	2.40	5.28	3.82	2.45	5.43	3.77	2.48	5.73	3.67	2.53	6.08	3.58	2.54
50	3.61	2.95	2.17	4.70	3.52	2.22	4.86	3.61	2.26	4.95	3.61	2.31	5.06	3.54	2.33	5.28	3.41	2.38	5.55	3.28	2.39
52	3.61	2.95	2.04	4.45	3.36	2.08	4.54	3.42	2.12	4.63	3.40	2.16	4.70	3.31	2.18	4.84	3.14	2.23	5.01	2.98	2.24
54	3.61	2.95	1.90	4.14	3.16	1.94	4.22	3.21	1.98	4.31	3.19	2.02	4.34	3.08	2.04	4.39	2.86	2.08	4.48	2.68	2.09

Note

- DB : Dry bulb temperature(°C), WB : Wet bulb temperature(°C)
- TC : Total Capacity(kW), SHC : Sensible Heat Capacity(kW)
- PI : Power Input (kW, Compressor + indoor fan motor + outdoor fan motor)
- All capacities are net. A deduction of capacity due to operating heat of indoor unit motor is reflected.
- Direct interpolation is permissible. Do not extrapolate.
- Rated capacities and power inputs are based on standard temperature and piping conditions, and it can be found on specifications table.
Except for rated value, the performance is not guaranteed.
- In accordance with the test standard(or nations), the rating will vary slightly.

4. ATUW24GTLP1 + ATNW24GTLP1

4.7.2 Heating

Outdoor Air Temp. (°C, WB)	Indoor Air Temp. (°C, DB)									
	16.0		18.0		20.0		22.0		24.0	
	TC	PI	TC	PI	TC	PI	TC	PI	TC	PI
-5.0	6.13	1.98	6.10	2.17	6.07	2.36	6.04	2.55	6.01	2.74
0.0	6.81	2.36	6.77	2.55	6.74	2.74	6.47	2.58	6.20	2.43
6.0	7.46	2.51	7.10	2.39	6.74	2.28	6.47	2.17	6.20	2.05
10.0	7.46	2.36	7.10	2.17	6.74	1.98	6.47	1.89	6.20	1.80
15.0	7.46	1.98	7.10	1.79	6.74	1.60	6.47	1.54	6.20	1.49
18.0	7.46	1.75	7.10	1.56	6.74	1.37	6.47	1.34	6.20	1.31

Note

- DB : Dry bulb temperature(°C), WB : Wet bulb temperature(°C)
- TC : Total Capacity(kW)
- PI : Power Input (kW, Compressor + indoor fan motor + outdoor fan motor)
- All capacities are net. An addition of capacity due to operating heat of indoor unit motor is reflected.
- Direct interpolation is permissible. Do not extrapolate.
- Rated capacities and power inputs are based on standard temperature and piping conditions, and it can be found on specifications table.
Except for rated value, the performance is not guaranteed.
- In accordance with the test standard(or nations), the rating will vary slightly.

4. ATUW24GTLP1 + ATNW24GTLP1

4.8 Capacity Correction Factor

Operation	Capacity correction factor (%) by Equivalent pipe length (m)										
	5	7.5	10	15	20	25	30	35	40	45	50
Cooling	100.0	99.9	99.8	99.3	98.8	98.3	97.8	94.4	91.1	89.8	88.4
Heating	100.0	99.9	99.8	99.4	99.0	98.6	98.3	97.4	96.6	96.1	95.6

Note

In Order to estimate the actual system capacity, the influence of various installation conditions should be reflected.

Reflect the capacity correction factor effect of piping installation as below.

- Qodu [from specification table] : Outdoor unit standard capacity.
- Q(Ti, To) [from capacity table] : Outdoor unit capacity at Ti, To temperature.
- F(Ti, To) = Q(Ti, To) / Qodu. : Outdoor unit capacity correction factor
- Fpiping for piping length [from capacity correction factor table] : Piping correction factor
- Indoor unit actual capacity : Qactual = Qodu x F(Ti, To) x Fpiping

4. ATUW24GTLP1 + ATNW24GTLP1

4.9 Operation Limits

4.9.1 Cooling

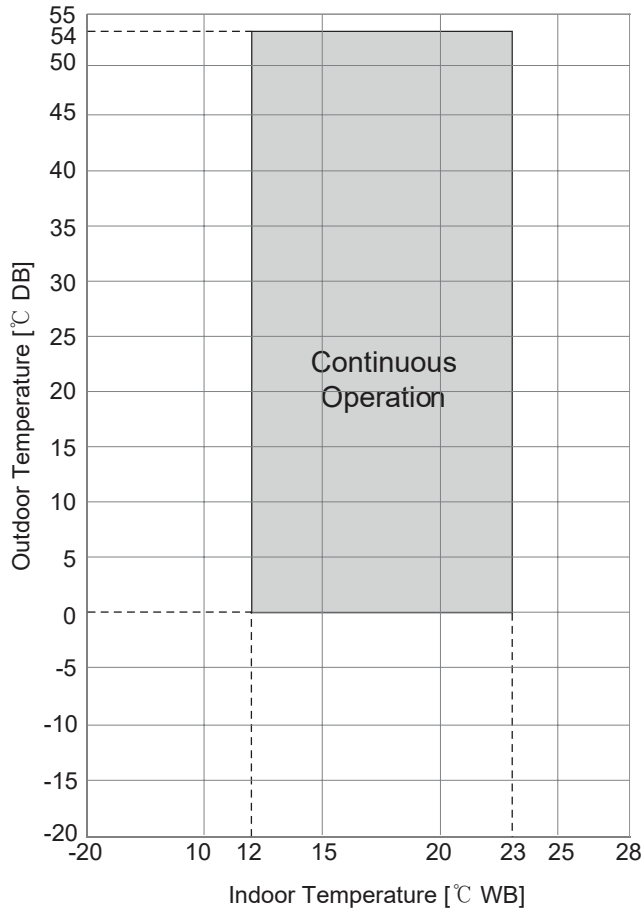

4. ATUW24GTLP1 + ATNW24GTLP1

4.9.2 Heating

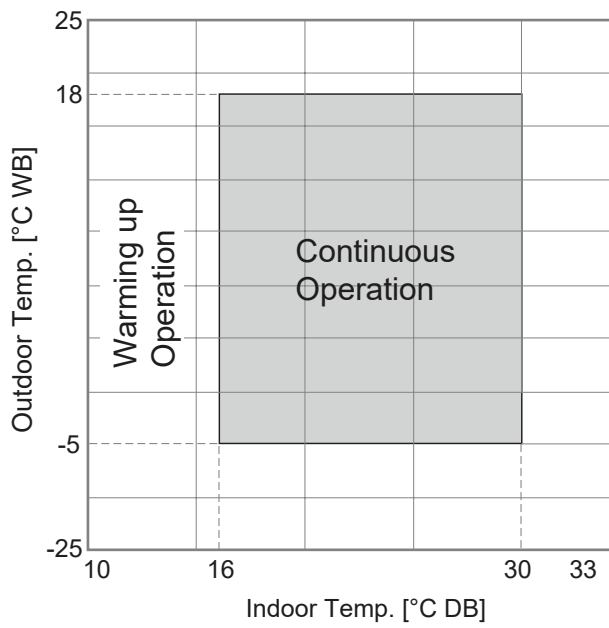
**Note**

- Warming up operation and operative mean that the outdoor unit operates to reach the range of continuous operating, however it may not operate continuously due to safety or protection logic.

4. ATUW24GTLP1 + ATNW24GTLP1

4.10 Sound Levels

4.10.1 Pressure Levels

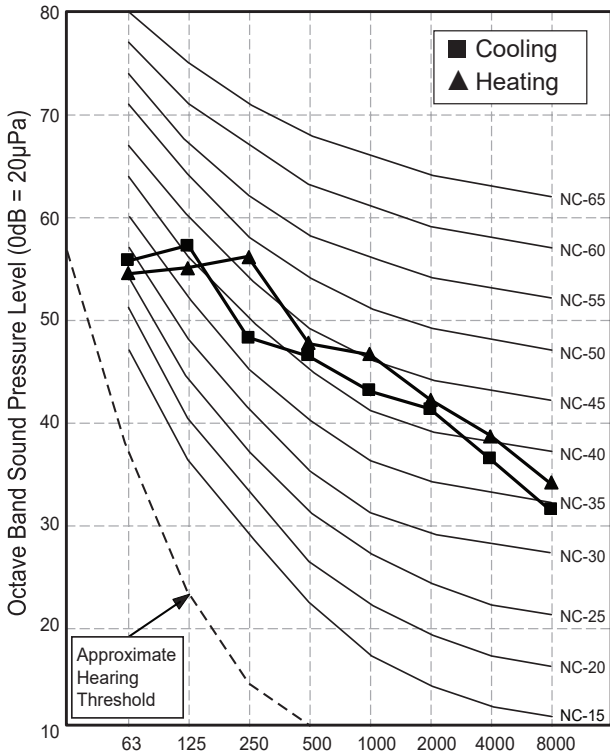

Sound level [dB(A), @ Standard condition]	
Cooling / Heating (@ 1.5m height)	50.0 / 52.0

Note

- Data is valid at diffuse field condition.
- Data is valid at nominal operating condition. Refer to the model specifications for nominal conditions.(Power source and Ambient temperature, etc)
- Reference acoustic pressure 0dB = 20µPa.
- Sound levels can be increased in accordance with installation and operating conditions. (Operating conditions include some functional condition like Static pressure mode, air guide use, Room target temperature setting, etc and these functions are different in accordance with each model.)
- Sound level will vary depending on a range of factors such as the construction(acoustic absorption coefficient) of particular room in which the equipment in installed.
- Sound pressure level is measured on the rated condition in the anechoic rooms by ISO 3745 Standard. Therefore, these values can be increased owing to ambient conditions during operation.

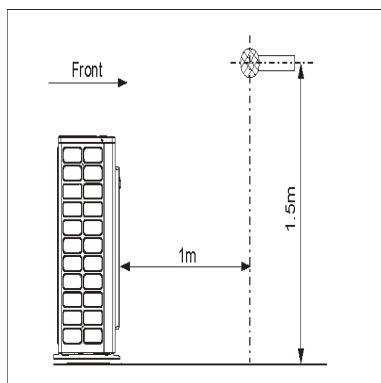

5. ATUW36GNLP1 + ATNW36GNLP1

5.1 Specifications

Category		Unit	Specification
Major	Minor		
Classification	Chassis	-	U36A
	Cooling / Heating	-	H/P
Power Supply	Case 1	-	220, 1, 60
	Case 2	-	-
	Limit Range of Voltage(Case 1)	V	198~242
	Limit Range of Voltage(Case 2)	V	-
Cooling Capacity	Rated	kW	9.09
		Btu/h	31,000
	Min ~ Max	kW	4.68~11.10
		Btu/h	16,030~38,000
	Sensible	kW	7.72
		Btu/h	26,350
Heating Capacity	Rated	kW	10.55
		Btu/h	36,000
	Min ~ Max	kW	3.99~10.80
		Btu/h	13,640~37,000
Power Input(Cooling)	Rated	kW	2.88
	Min ~ Max	kW	~
Power Input(Heating)	Rated	kW	3.08
	Min ~ Max	kW	~
Efficiency	EER	W/W	3.15
	COP	W/W	3.43
	SEER	Wh/Wh	6.05
Running Current(Cooling)	Rated	A	13.10
	Min/Max	A	- / -
Running Current(Heating)	Rated	A	14.00
	Min/Max	A	- / -
Running Current	Max	A	19.00
Power Factor(Cooling/Heating)	Rated	-	0.99 / 0.99
Outdoor Fan	Type	-	Propeller
	Air Flow Rate(Max)	m ³ /min x No.	60 x 1
	Max. External Static Pressure	Pa	-
Outdoor Fan Motor	Type	-	BLDC
	Drive	-	-
	Output	W x No.	124.2 x 1
Compressor	Type	-	Twin Rotary
	Model x No.	-	GJT240MAA x 1
	Motor Type	-	BLDC
	Motor Output	W x No.	2,137 x 1
	Oil Type	-	PVE
	Oil Charging amount	cc x No.	900 x 1
Heat Exchanger	Rows x Columns x FPI	-	2 x 38 x 14
	No.	-	1
	Fin Type	-	Wide Louver Plus
	Corrosion Protection (Coating)	-	-
	Material (Tube / Fin)	-	-
	Face Area	m ²	-
Dimensions	Net(W x H x D)	mm	950 x 834 x 330
	Shipping(W x H x D)	mm	1,140 x 918 x 461
Weight	Net	kg	58.5

5. ATUW36GNLP1 + ATNW36GNLP1

Category		Unit	Specification
Major	Minor		
Weight	Shipping	kg	65.6
Exterior	Color	-	Warm Gray
	RAL (Classic)	-	RAL 7044
Protection Device	High Pressure Prevention	-	-
	Frost Prevention	-	-
	Discharge Temperature Control	-	-
	Inverter Protection	-	-
Refrigerant	Type	-	R410A
	Precharged Amount	kg	2.200
	Additional Charging amount	g/m	40
	GWP(Global Warming Potential)	-	2,087.5
	t-CO ₂ eq.	-	4.593
	Chargeless-Pipe Length	m	7.5
	Control Type	-	EEV
Connecting Pipe	Liquid	mm(inch)	Φ9.52 (3/8)
	Gas	mm(inch)	Φ15.88 (5/8)
Pipe Connecting Socket	Liquid	mm(inch)	Φ9.52 (3/8)
	Gas	mm(inch)	Φ15.88 (5/8)
	Connection Type(Liquid)	-	Flare
	Connection Type(Gas)	-	Flare
Piping Length Limit	IDU - ODU(Rated / Max / Min)	m	5 / 50 / 5
Maximum Height Difference	IDU - ODU(Max)	m	30
Sound Pressure Level (Outdoor Unit)	Cooling / Heating (@ 1.5m height)	dB(A)	51.0 / 53.0
Measurement Standard (Pressure Level)	-	-	ISO 3745
Sound Power Level (Outdoor Unit)	Cooling / Heating	dB(A)	-
Measurement Standard (Power Level)	-	-	-
Connecting Cable	Power Supply Cable(H07RN-F)	mm ² × cores	2.5 x 3C
Electrical Characteristic	Minimum Circuit Amperes (MCA)	A	23.2
	Maximum Fuse Amperes (MFA)	A	25
	Comp_Rated Load Amperes (Max)	A	17.0
	Outdoor Fan Motor_Full Load Amperes (FLA)	A	0.58

Note

- Due to our policy of innovation some specifications may be changed without notification.
- Wiring cable size must comply with the applicable local and national codes. And "Electric characteristics" should be considered for electrical work and design. Especially the power cable and circuit breaker should be selected in accordance with that.
- Power factor could vary less than ±1% according to the operating conditions.
- Sound level values are depend on the ambient conditions and values are normally higher in actual operation.
- This product contains Fluorinated greenhouse gases.
- Voltage supplied to the unit terminals should be within the minimum and maximum range.
- Maximum allowable voltage unbalance between phase is 2%.
- MSC means the Max. current during the starting of compressor.
- MSC and RLA are measured as the compressor only test condition.
- OFM and IFM are measured as the outdoor unit test condition.
- Select the wire size based on MCA.
- MFA is used to select the circuit breaker and ground fault circuit interrupter, and all installation site must require attachment of an earth leakage breaker. [circuit breaker type is ELCB(Earth Leakage Circuit Breaker)].
- Performances are based on the following conditions :
 - Cooling : Indoor Ambient Temp. 27°CDB / 19°CWB, Outdoor Ambient Temp. 35°CDB / 24°CWB
 - Heating : Indoor Ambient Temp. 20°CDB / 15°CWB, Outdoor Ambient Temp. 7°CDB / 6°CWB
 - Interconnected Pipe Length is standard length and difference of Elevation (Outdoor ~ Indoor Unit) is 0m.

5. ATUW36GNLP1 + ATNW36GNLP1

5.2 List of Functions

Category	Functions	Availability
Reliability	Defrost / Deicing	O
	High Pressure Switch	X
	Low Pressure Switch	X
	Phase Protection	X
	Restart Delay (3-minutes)	O
	Self Diagnosis	O
	Soft Start	O
Convenience	Night Low Noise Operation	O
	Wiring Error Check	X
	Peak Control	O
	Mode Lock	O
	Forced Cooling Operation (Outdoor Unit)	X
	Advanced SLC (Smart Load Control)	X
Special Functions	ODU Dry Contact Function	X

Note

■ O : Applied, X : Not applied

- Accessory : Ordered and purchased separately the accessory package referring to the model name provided and install at field.

- Accessory line-ups varies by region, so check your local catalogue or local sales material.

5. ATUW36GNLP1 + ATNW36GNLP1

5.3 Accessory Compatibility List

Category	Accessory Name	Model Name	Description	Compatibility
Central Controller	AC EZ	PQCSZ250S0	-	O
	AC EZ touch	PACEZA000	Touch type	O
	AC Smart IV	PACS4B000	Touch type	O
	AC Smart 5	PACS5A000	Touch type	O
	ACP IV	PACP4B000	-	O
	ACP 5	PACP5A000	-	O
	AC Manager IV	PACM4B000	For Integrated Control	O
	AC Manager 5	PACM5A000	For Integrated Control	O
Gateway	ODU PI485	PMNFP14A1	For 16-room (3 series)	O
	ACP BACnet	PQNFB17C0	-	O
	ACP Lonwork	PLNWKB000	-	O
	Cloud Gateway	PWFMDB200	-	O
Integration Device	AHU comm. kit	PAHCMR000	For AHU Control (Multi V / Single ODU Communication)	O
		PAHCMS000	For AHU Control (Multi V / Single ODU Communication)	X
	AHU Controller Module	PAHCMC000	For AHU Control (Communication Module)	X
		PAHCMM000	For AHU Control (Main Module)	X
	PDI Standard	PPWRDB000	Power distributor 2port	X
	PDI Premium	PQNUD1S40	Power distributor 8port	X

Note

- O: Possible, X: Impossible, -: Unconfirmed or irrelevant
- AC Manager requires ACP or AC Smart.
- Compatibility of individual controller(wireless/wired remote controller) could be found with function list on Indoor Unit's PDB.
- If you need more detail, please refer to the Control(BECON) PDB or the manual of product.
(<http://partner.lge.com/global> : Home> Doc.Library> Product > Control(BECON)).
- Accessory line-ups varies by region, so check your local catalogue or local sales material.

5. ATUW36GNLP1 + ATNW36GNLP1

5.4 Dimensions

5.4.1 Product

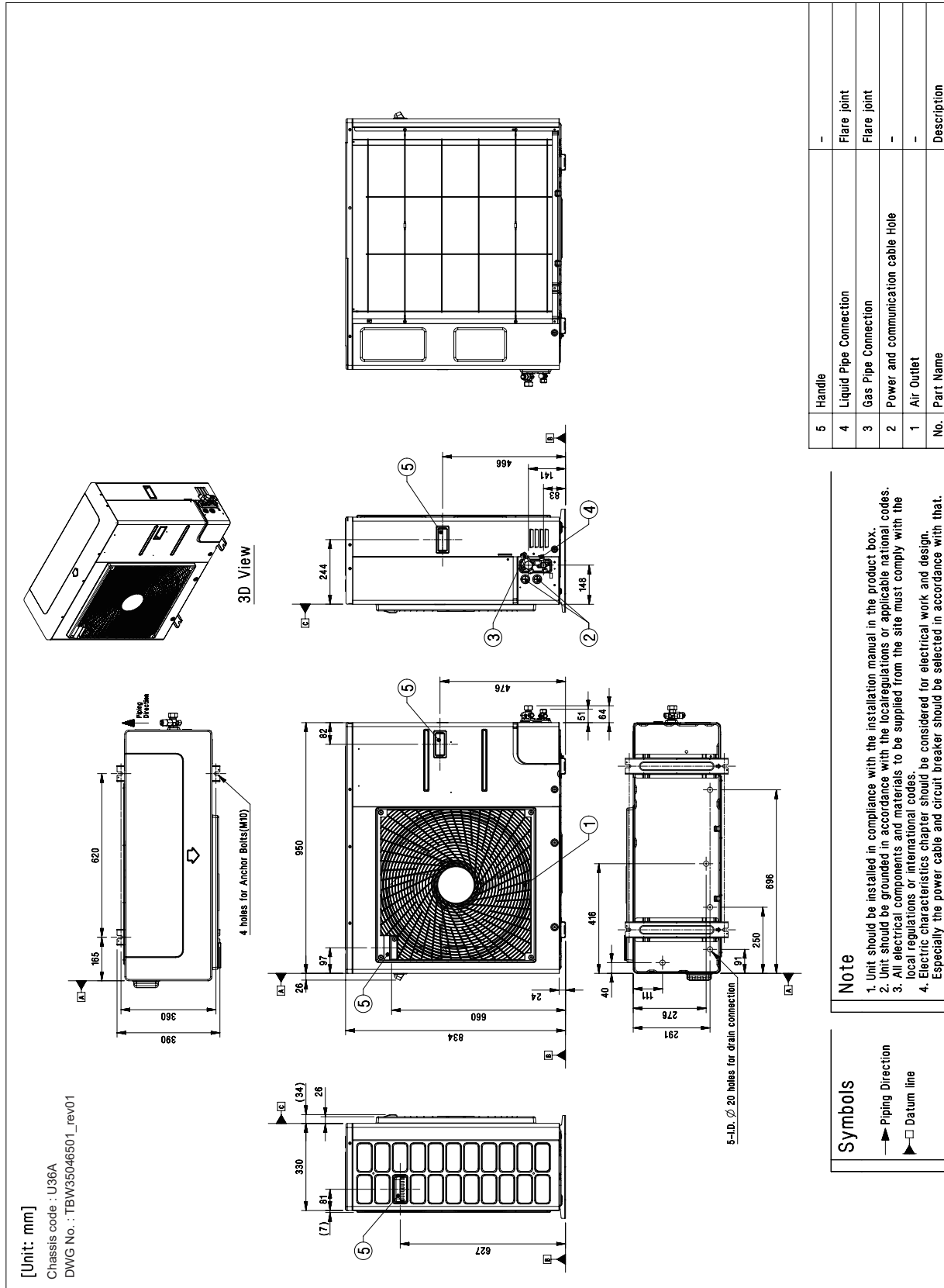

5. ATUW36GNLP1 + ATNW36GNLP1

5.4.2 Install Space

For Side Discharge (capacity < 28.0 kW)

Obstacle on the Suction side

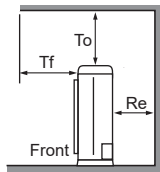

To ≥ 1,000(39-3/8)
Tf ≤ 500(19-11/16)

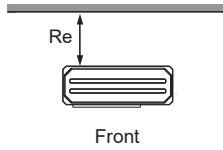

Case 1
Re ≥ 100(3-15/16)
Case 2
Re ≥ 300(11-13/16)

※ Case 1 : No obstacle on top side
Case 2 : Obstacle on top side

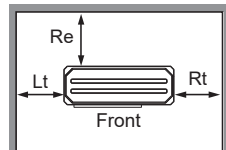

Case 1
Re ≥ 100(3-15/16)
Lt ≥ 100(3-15/16)
Case 2
Re ≥ 300(11-13/16)
Lt ≥ 150(5-29/32)
Rt ≥ 150(5-29/32)

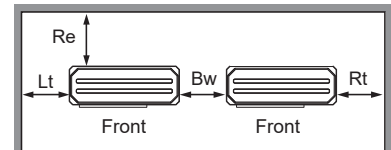

Case 1
Re ≥ 300(11-13/16)
Lt ≥ 1,000(39-3/8)
Rt ≥ 200(7-7/8)
Bw ≥ 100(3-15/16)
Case 2
Re ≥ 300(11-13/16)
Lt ≥ 1,000(39-3/8)
Rt ≥ 200(7-7/8)
Bw ≥ 100(3-15/16)

[Unit : mm(inch)]

Obstacle on the Discharge side

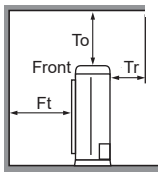
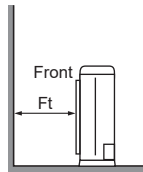

To ≥ 1,000(39-3/8)
Tr ≤ 500(19-11/16)

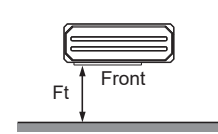

Case 1
Ft ≥ 500(19-11/16)
Case 2
Ft ≥ 500(19-11/16)

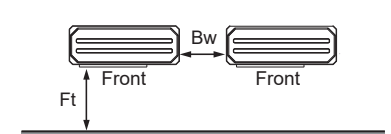

Case 1
Ft ≥ 1,000(39-3/8)
Bw ≥ 100(3-15/16)
Case 2
Ft ≥ 1,000(39-3/8)
Bw ≥ 100(3-15/16)

※ For Rear Piping / External SVC Valve type / Side-CBOX type
: Re, Lt ≥ 300(11-13/16) and Rt, Bw, Rb ≥ 600(23-5/8) for ALL CASE.

Obstacle on the Suction and Discharge side

Ld > H (Ls should be lower H.)

※ Close the bottom of the installation frame to prevent the discharged air from being bypassed

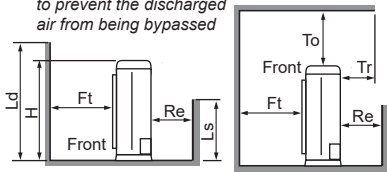

To ≥ 1,000(39-3/8)
Tf ≤ 500(19-11/16)

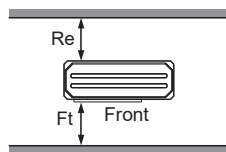

Case 1
Ft ≥ 500(19-11/16)
Re ≥ 300(11-13/16)
Case 2
Ft ≥ 1,000(39-3/8) *
Re ≥ 300(11-13/16)
* If Ls ≤ H/2,
Ft ≥ 750(29-17/32)

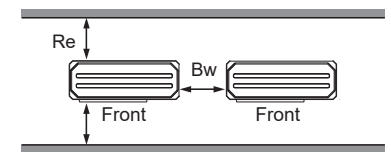

Case 1
Ft ≥ 1,000(39-3/8)
Re ≥ 300(11-13/16)
Bw ≥ 100(3-15/16)
Case 2
Ft ≥ 1,250(49-7/32)
Re ≥ 300(11-13/16)
Bw ≥ 100(3-15/16)

Ld ≤ H

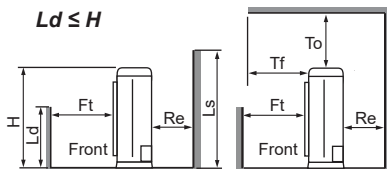

To ≥ 1,000(39-3/8)
Tf ≤ 500(19-11/16)

Case 1
Ft ≥ 500(19-11/16)
Re ≥ 300(11-13/16)
Case 2
Ft ≥ 1,000(39-3/8)
Re ≥ 300(11-13/16)

Case 1
Ft ≥ 1,500(59-1/16)
Re ≥ 300(11-13/16)
Bw ≥ 100(3-15/16)
Case 2
Ft ≥ 1,500(59-1/16)
Re ≥ 300(11-13/16)
Bw ≥ 100(3-15/16)

※ In case of series installation (2 Units or more) for 2 Fan models, Ld should be lower than H/2.

Collective/Continuous Installation (Multiple Columns)

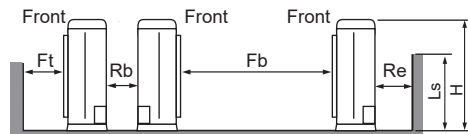

※ In case of Multiple columns/continuous installation, Ls should be lower than H.

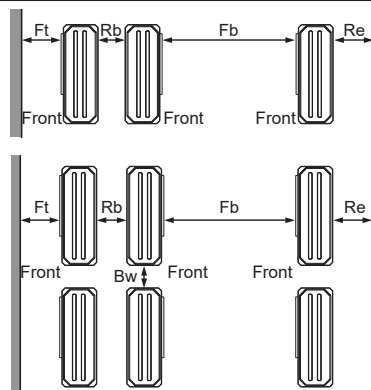

1 Column

Ft ≥ 1,000(39-3/8)
Rb ≥ 200(7-7/8)
Fb ≥ 2,000(78-3/4)
Re ≥ 100(3-15/16)

Multiple Columns

Ft ≥ 1,500(59-1/16)
Rb ≥ 600(23-5/8)
Fb ≥ 3,000(118-1/8)
Re ≥ 300(11-13/16)
Bw ≥ 100(3-15/16)

Note

- If there is a concern about product performance degradation due to group installation or interference with obstacles, secure an additional separation distance.
- Secure enough space for smooth service and maintenance.
- According to product type, model line up, sales region..etc, applicability of each chassis could be different.

5. ATUW36GNLP1 + ATNW36GNLP1

5.5 Piping Diagrams

5.5.1 Normal

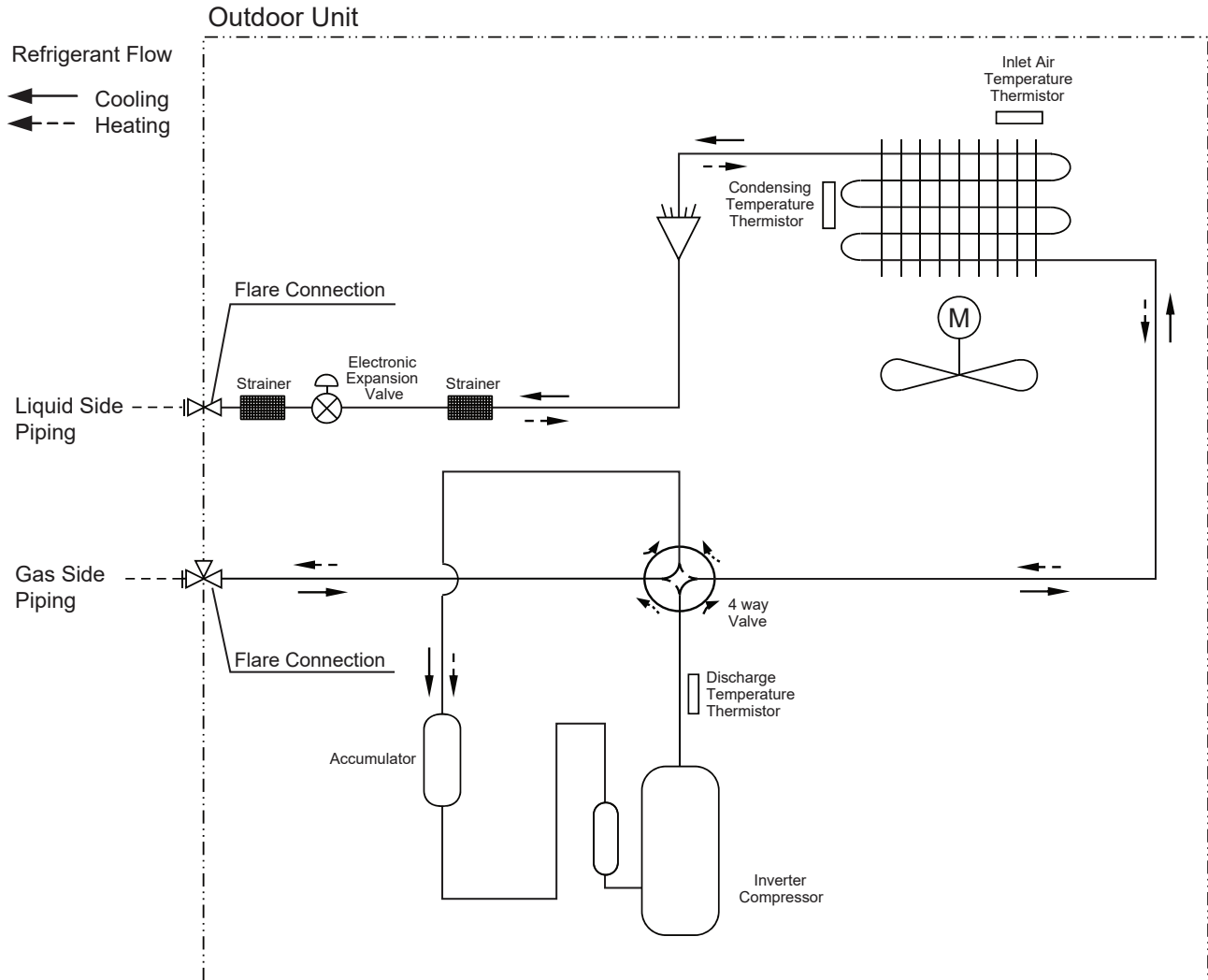

5. ATUW36GNLP1 + ATNW36GNLP1

5.6 Wiring Diagrams

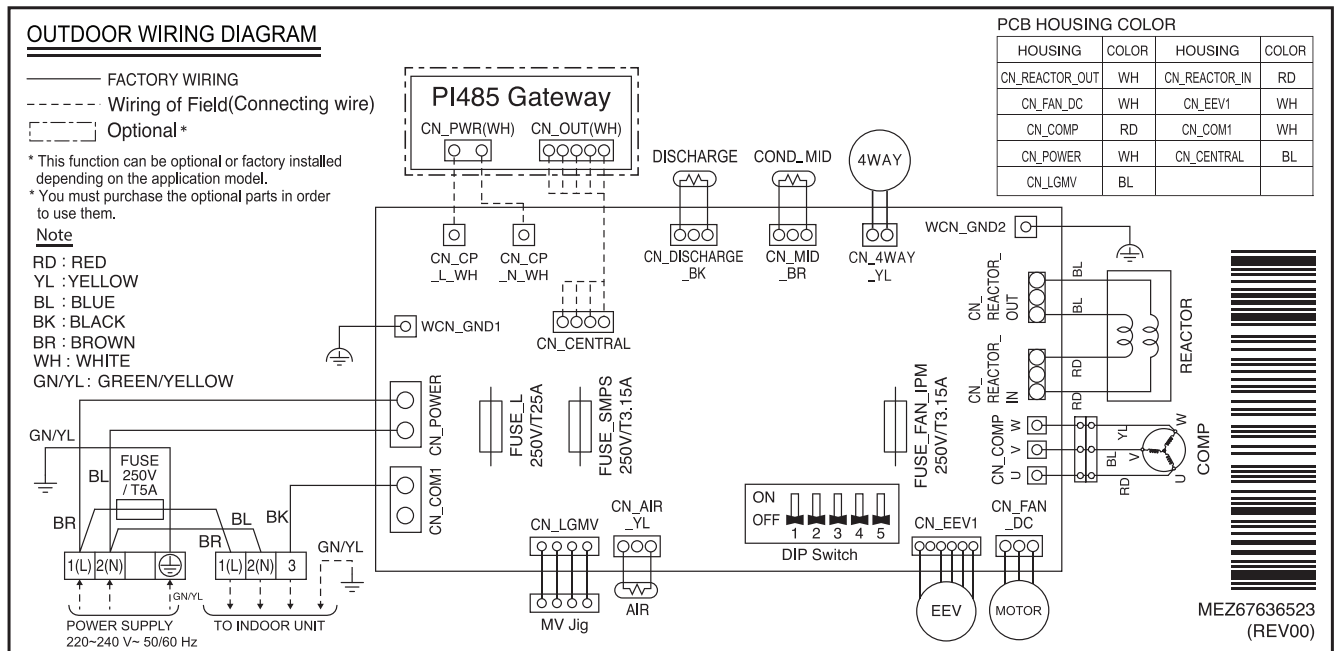

5. ATUW36GNLP1 + ATNW36GNLP1

5.7 Capacity Tables

5.7.1 Cooling

Outdoor Air Temp. (°C, DB)	Indoor Air Temp. (°C, DB/WB)																				
	20.0 / 14.0			22.0 / 16.0			25.0 / 18.0			27.0 / 19.0			28.0 / 20.0			30.0 / 22.0			32.0 / 24.0		
	TC	SHC	PI	TC	SHC	PI	TC	SHC	PI	TC	SHC	PI	TC	SHC	PI	TC	SHC	PI	TC	SHC	PI
20	5.34	5.20	1.17	6.94	6.21	1.47	8.16	7.22	1.71	9.09	7.72	1.87	9.40	7.67	1.89	10.02	7.58	1.93	10.72	7.48	1.94
25	5.34	5.20	1.38	6.94	6.21	1.74	8.16	7.22	2.01	9.09	7.72	2.21	9.40	7.67	2.23	10.02	7.58	2.27	10.72	7.48	2.29
32	5.34	5.20	1.68	6.94	6.21	2.11	8.16	7.22	2.44	9.09	7.72	2.68	9.40	7.67	2.71	10.02	7.58	2.76	10.72	7.48	2.77
35	5.34	5.20	1.81	6.94	6.21	2.27	8.16	7.22	2.63	9.09	7.72	2.88	9.40	7.67	2.91	10.02	7.58	2.97	10.72	7.48	2.98
40	5.34	5.20	2.14	6.94	6.21	2.69	8.16	7.22	3.12	9.09	7.72	3.42	9.40	7.67	3.45	10.02	7.58	3.52	10.72	7.48	3.54
43	5.34	5.20	2.35	6.94	6.21	2.95	8.16	7.22	3.41	9.09	7.72	3.74	9.40	7.67	3.78	10.02	7.58	3.86	10.72	7.48	3.88
46	5.34	5.20	2.57	6.94	6.21	3.23	7.76	6.91	3.52	7.92	6.80	3.59	8.19	6.75	3.63	8.73	6.66	3.70	9.35	6.56	3.72
48	5.34	5.20	2.81	6.94	6.21	3.31	7.38	6.57	3.38	7.53	6.52	3.45	7.74	6.43	3.49	8.17	6.26	3.56	8.66	6.11	3.58
50	5.34	5.20	3.08	6.94	6.21	3.18	7.00	6.23	3.24	7.14	6.23	3.31	7.30	6.11	3.34	7.61	5.87	3.41	7.98	5.65	3.43
52	5.34	5.20	2.98	6.49	5.87	3.04	6.62	5.96	3.10	6.75	5.93	3.17	6.85	5.78	3.20	7.05	5.47	3.26	7.30	5.19	3.28
54	5.34	5.20	2.85	6.11	5.59	2.90	6.24	5.67	2.96	6.36	5.63	3.02	6.40	5.44	3.05	6.49	5.06	3.12	6.62	4.73	3.13

Note

- DB : Dry bulb temperature(°C), WB : Wet bulb temperature(°C)
- TC : Total Capacity(kW), SHC : Sensible Heat Capacity(kW)
- PI : Power Input (kW, Compressor + indoor fan motor + outdoor fan motor)
- All capacities are net. A deduction of capacity due to operating heat of indoor unit motor is reflected.
- Direct interpolation is permissible. Do not extrapolate.
- Rated capacities and power inputs are based on standard temperature and piping conditions, and it can be found on specifications table.
Except for rated value, the performance is not guaranteed.
- In accordance with the test standard(or nations), the rating will vary slightly.

5. ATUW36GNLP1 + ATNW36GNLP1

5.7.2 Heating

Outdoor Air Temp. (°C, WB)	Indoor Air Temp. (°C, DB)									
	16.0		18.0		20.0		22.0		24.0	
	TC	PI	TC	PI	TC	PI	TC	PI	TC	PI
-5.0	9.60	2.67	9.55	2.93	9.50	3.18	9.45	3.44	9.40	3.70
0.0	10.66	3.18	10.60	3.44	10.55	3.70	10.13	3.49	9.71	3.28
6.0	11.68	3.39	11.11	3.23	10.55	3.08	10.13	2.93	9.71	2.77
10.0	11.68	3.18	11.11	2.93	10.55	2.67	10.13	2.55	9.71	2.44
15.0	11.68	2.67	11.11	2.41	10.55	2.16	10.13	2.09	9.71	2.02
18.0	11.68	2.36	11.11	2.10	10.55	1.85	10.13	1.81	9.71	1.77

Note

- DB : Dry bulb temperature(°C), WB : Wet bulb temperature(°C)
- TC : Total Capacity(kW)
- PI : Power Input (kW, Compressor + indoor fan motor + outdoor fan motor)
- All capacities are net. An addition of capacity due to operating heat of indoor unit motor is reflected.
- Direct interpolation is permissible. Do not extrapolate.
- Rated capacities and power inputs are based on standard temperature and piping conditions, and it can be found on specifications table.
Except for rated value, the performance is not guaranteed.
- In accordance with the test standard(or nations), the rating will vary slightly.

5. ATUW36GNLP1 + ATNW36GNLP1

5.8 Capacity Correction Factor

Operation	Capacity correction factor (%) by Equivalent pipe length (m)										
	5	7.5	10	15	20	25	30	35	40	45	50
Cooling	100.0	99.6	99.3	97.9	96.6	95.2	93.8	92.4	91.1	89.8	88.4
Heating	100.0	99.9	99.7	99.2	98.7	98.2	97.7	97.1	96.6	96.1	95.6

Note

In Order to estimate the actual system capacity, the influence of various installation conditions should be reflected.

Reflect the capacity correction factor effect of piping installation as below.

- Qodu [from specification table] : Outdoor unit standard capacity.
- Q(Ti, To) [from capacity table] : Outdoor unit capacity at Ti, To temperature.
- F(Ti, To) = Q(Ti, To) / Qodu. : Outdoor unit capacity correction factor
- Fpiping for piping length [from capacity correction factor table] : Piping correction factor
- Indoor unit actual capacity : Qactual = Qodu x F(Ti, To) x Fpiping

5. ATUW36GNLP1 + ATNW36GNLP1

5.9 Operation Limits

5.9.1 Cooling

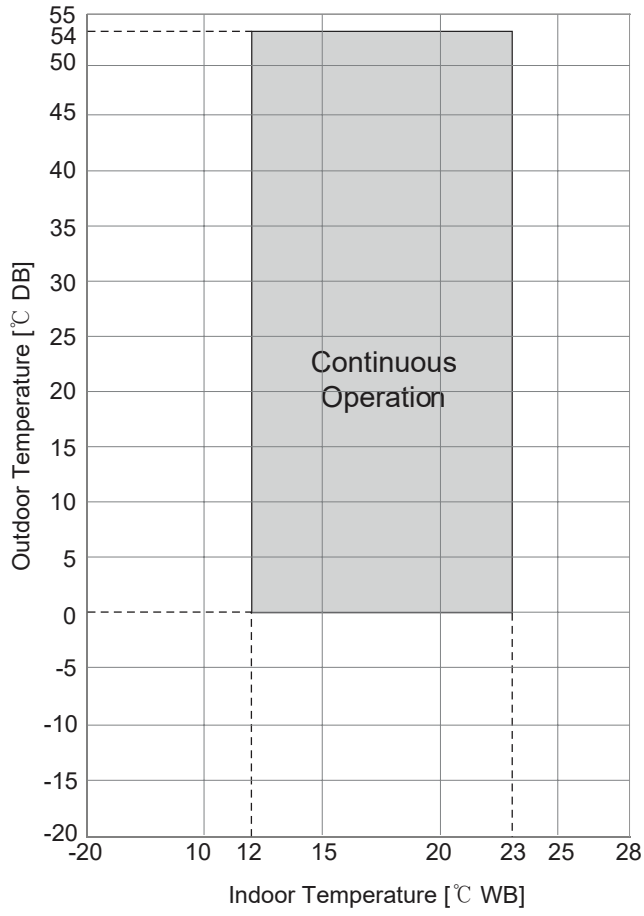

5. ATUW36GNLP1 + ATNW36GNLP1

5.9.2 Heating

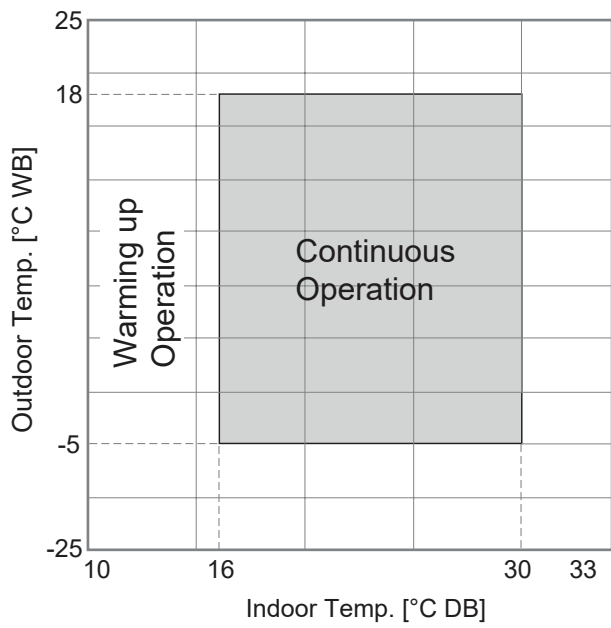

Note

- Warming up operation and operative mean that the outdoor unit operates to reach the range of continuous operating, however it may not operate continuously due to safety or protection logic.

5. ATUW36GNLP1 + ATNW36GNLP1

5.10 Sound Levels

5.10.1 Pressure Levels

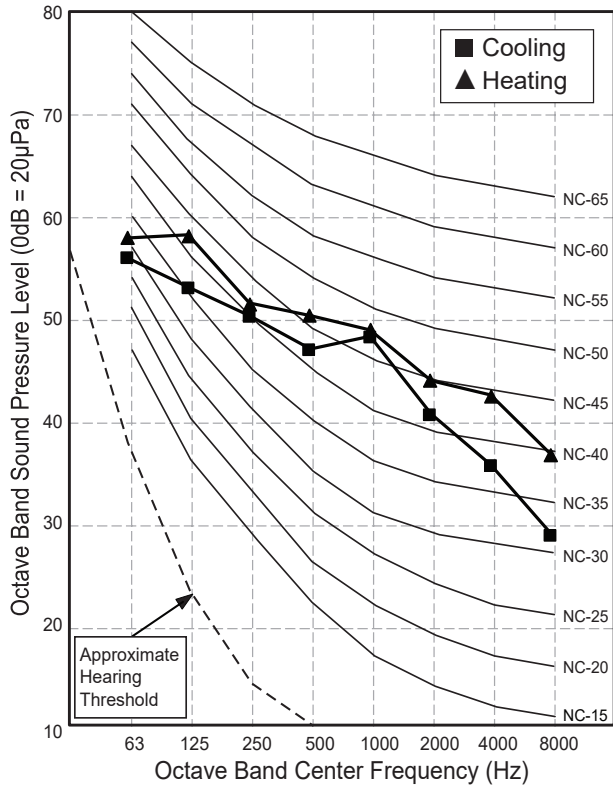

Sound level [dB(A), @ Standard condition]	
Cooling / Heating (@ 1.5m height)	51.0 / 53.0

Note

- Data is valid at diffuse field condition.
- Data is valid at nominal operating condition. Refer to the model specifications for nominal conditions.(Power source and Ambient temperature, etc)
- Reference acoustic pressure 0dB = 20µPa.
- Sound levels can be increased in accordance with installation and operating conditions. (Operating conditions include some functional condition like Static pressure mode, air guide use, Room target temperature setting, etc and these functions are different in accordance with each model.)
- Sound level will vary depending on a range of factors such as the construction(acoustic absorption coefficient) of particular room in which the equipment in installed.
- Sound pressure level is measured on the rated condition in the anechoic rooms by ISO 3745 Standard. Therefore, these values can be increased owing to ambient conditions during operation.

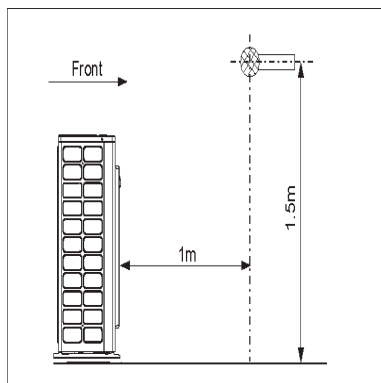

6. AVUW36GM1P1 + AVNW36GM1P1

6.1 Specifications

Category		Unit	Specification
Major	Minor		
Classification	Chassis	-	U36A
	Cooling / Heating	-	H/P
Power Supply	Case 1	-	220, 1, 60
	Case 2	-	-
	Limit Range of Voltage(Case 1)	V	198~242
	Limit Range of Voltage(Case 2)	V	-
Cooling Capacity	Rated	kW	8.79
		Btu/h	30,000
	Min ~ Max	kW	4.00~10.30
		Btu/h	13,600~35,000
	Sensible	kW	7.03
		Btu/h	24,000
Heating Capacity	Rated	kW	9.97
		Btu/h	34,000
	Min ~ Max	kW	4.30~11.70
		Btu/h	14,700~39,900
Power Input(Cooling)	Rated	kW	2.79
	Min ~ Max	kW	~
Power Input(Heating)	Rated	kW	3.05
	Min ~ Max	kW	~
Efficiency	EER	W/W	3.15
	COP	W/W	3.27
	SEER	Wh/Wh	5.90
Running Current(Cooling)	Rated	A	12.70
	Min/Max	A	- / -
Running Current(Heating)	Rated	A	13.90
	Min/Max	A	- / -
Running Current	Max	A	19.00
Power Factor(Cooling/Heating)	Rated	-	0.99 / 0.99
Outdoor Fan	Type	-	Propeller
	Air Flow Rate(Max)	m ³ /min x No.	60 x 1
	Max. External Static Pressure	Pa	-
Outdoor Fan Motor	Type	-	BLDC
	Drive	-	-
	Output	W x No.	124.2 x 1
Compressor	Type	-	Twin Rotary
	Model x No.	-	GJT240MAA x 1
	Motor Type	-	BLDC
	Motor Output	W x No.	2,137 x 1
	Oil Type	-	PVE
	Oil Charging amount	cc x No.	900 x 1
Heat Exchanger	Rows x Columns x FPI	-	2 x 38 x 14
	No.	-	1
	Fin Type	-	Wide Louver Plus
	Corrosion Protection (Coating)	-	-
	Material (Tube / Fin)	-	-
	Face Area	m ²	-
Dimensions	Net(W x H x D)	mm	950 x 834 x 330
	Shipping(W x H x D)	mm	1,140 x 918 x 461
Weight	Net	kg	58.5

6. AVUW36GM1P1 + AVNW36GM1P1

Category		Unit	Specification
Major	Minor		
Weight	Shipping	kg	65.5
Exterior	Color	-	Warm Gray
	RAL (Classic)	-	RAL 7044
Protection Device	High Pressure Prevention	-	-
	Frost Prevention	-	-
	Discharge Temperature Control	-	-
	Inverter Protection	-	-
Refrigerant	Type	-	R410A
	Precharged Amount	kg	2.200
	Additional Charging amount	g/m	40
	GWP(Global Warming Potential)	-	2,087.5
	t-CO ₂ eq.	-	4.593
	Chargeless-Pipe Length	m	7.5
	Control Type	-	EEV
Connecting Pipe	Liquid	mm(inch)	Φ9.52 (3/8)
	Gas	mm(inch)	Φ15.88 (5/8)
Pipe Connecting Socket	Liquid	mm(inch)	Φ9.52 (3/8)
	Gas	mm(inch)	Φ15.88 (5/8)
	Connection Type(Liquid)	-	Flare
	Connection Type(Gas)	-	Flare
Piping Length Limit	IDU - ODU(Rated / Max / Min)	m	5 / 50 / 5
Maximum Height Difference	IDU - ODU(Max)	m	30
Sound Pressure Level (Outdoor Unit)	Cooling / Heating (@ 1.5m height)	dB(A)	51.0 / 53.0
Measurement Standard (Pressure Level)	-	-	ISO 3745
Sound Power Level (Outdoor Unit)	Cooling / Heating	dB(A)	-
Measurement Standard (Power Level)	-	-	-
Connecting Cable	Power Supply Cable(H07RN-F)	mm ² × cores	2.5 x 3C
Electrical Characteristic	Minimum Circuit Amperes (MCA)	A	23.2
	Maximum Fuse Amperes (MFA)	A	25
	Comp_Rated Load Amperes (Max)	A	17.0
	Outdoor Fan Motor_Full Load Amperes (FLA)	A	0.58

Note

- Due to our policy of innovation some specifications may be changed without notification.
- Wiring cable size must comply with the applicable local and national codes. And "Electric characteristics" should be considered for electrical work and design. Especially the power cable and circuit breaker should be selected in accordance with that.
- Power factor could vary less than ±1% according to the operating conditions.
- Sound level values are depend on the ambient conditions and values are normally higher in actual operation.
- This product contains Fluorinated greenhouse gases.
- Voltage supplied to the unit terminals should be within the minimum and maximum range.
- Maximum allowable voltage unbalance between phase is 2%.
- MSC means the Max. current during the starting of compressor.
- MSC and RLA are measured as the compressor only test condition.
- OFM and IFM are measured as the outdoor unit test condition.
- Select the wire size based on MCA.
- MFA is used to select the circuit breaker and ground fault circuit interrupter, and all installation site must require attachment of an earth leakage breaker. [circuit breaker type is ELCB(Earth Leakage Circuit Breaker)].
- Performances are based on the following conditions :
 - Cooling : Indoor Ambient Temp. 27°CDB / 19°CWB, Outdoor Ambient Temp. 35°CDB / 24°CWB
 - Heating : Indoor Ambient Temp. 20°CDB / 15°CWB, Outdoor Ambient Temp. 7°CDB / 6°CWB
 - Interconnected Pipe Length is standard length and difference of Elevation (Outdoor ~ Indoor Unit) is 0m.

6. AVUW36GM1P1 + AVNW36GM1P1**6.2 List of Functions**

Category	Functions	Availability
Reliability	Defrost / Deicing	O
	High Pressure Switch	X
	Low Pressure Switch	X
	Phase Protection	X
	Restart Delay (3-minutes)	O
	Self Diagnosis	O
	Soft Start	O
Convenience	Night Low Noise Operation	O
	Wiring Error Check	X
	Peak Control	O
	Mode Lock	O
	Forced Cooling Operation (Outdoor Unit)	X
	Advanced SLC (Smart Load Control)	X
Special Functions	ODU Dry Contact Function	X

Note

- O : Applied, X : Not applied
- Accessory : Ordered and purchased separately the accessory package referring to the model name provided and install at field.
- Accessory line-ups varies by region, so check your local catalogue or local sales material.

6. AVUW36GM1P1 + AVNW36GM1P1

6.3 Accessory Compatibility List

Category	Accessory Name	Model Name	Description	Compatibility
Central Controller	AC EZ	PQCSZ250S0	-	O
	AC EZ touch	PACEZA000	Touch type	O
	AC Smart IV	PACS4B000	Touch type	O
	AC Smart 5	PACS5A000	Touch type	O
	ACP IV	PACP4B000	-	O
	ACP 5	PACP5A000	-	O
	AC Manager IV	PACM4B000	For Integrated Control	O
	AC Manager 5	PACM5A000	For Integrated Control	O
Gateway	ODU PI485	PMNFP14A1	For 16-room (3 series)	O
	ACP BACnet	PQNFB17C0	-	O
	ACP Lonwork	PLNWKB000	-	O
	Cloud Gateway	PWFMDB200	-	O
Integration Device	AHU comm. kit	PAHCMR000	For AHU Control (Multi V / Single ODU Communication)	O
		PAHCMS000	For AHU Control (Multi V / Single ODU Communication)	X
	AHU Controller Module	PAHCMC000	For AHU Control (Communication Module)	X
		PAHCMM000	For AHU Control (Main Module)	X
	PDI Standard	PPWRDB000	Power distributor 2port	X
	PDI Premium	PQNUD1S40	Power distributor 8port	X

Note

- O: Possible, X: Impossible, -: Unconfirmed or irrelevant
- AC Manager requires ACP or AC Smart.
- Compatibility of individual controller(wireless/wired remote controller) could be found with function list on Indoor Unit's PDB.
- If you need more detail, please refer to the Control(BECON) PDB or the manual of product.
(<http://partner.lge.com/global> : Home> Doc.Library> Product > Control(BECON)).
- Accessory line-ups varies by region, so check your local catalogue or local sales material.

6. AVUW36GM1P1 + AVNW36GM1P1

6.4 Dimensions

6.4.1 Product

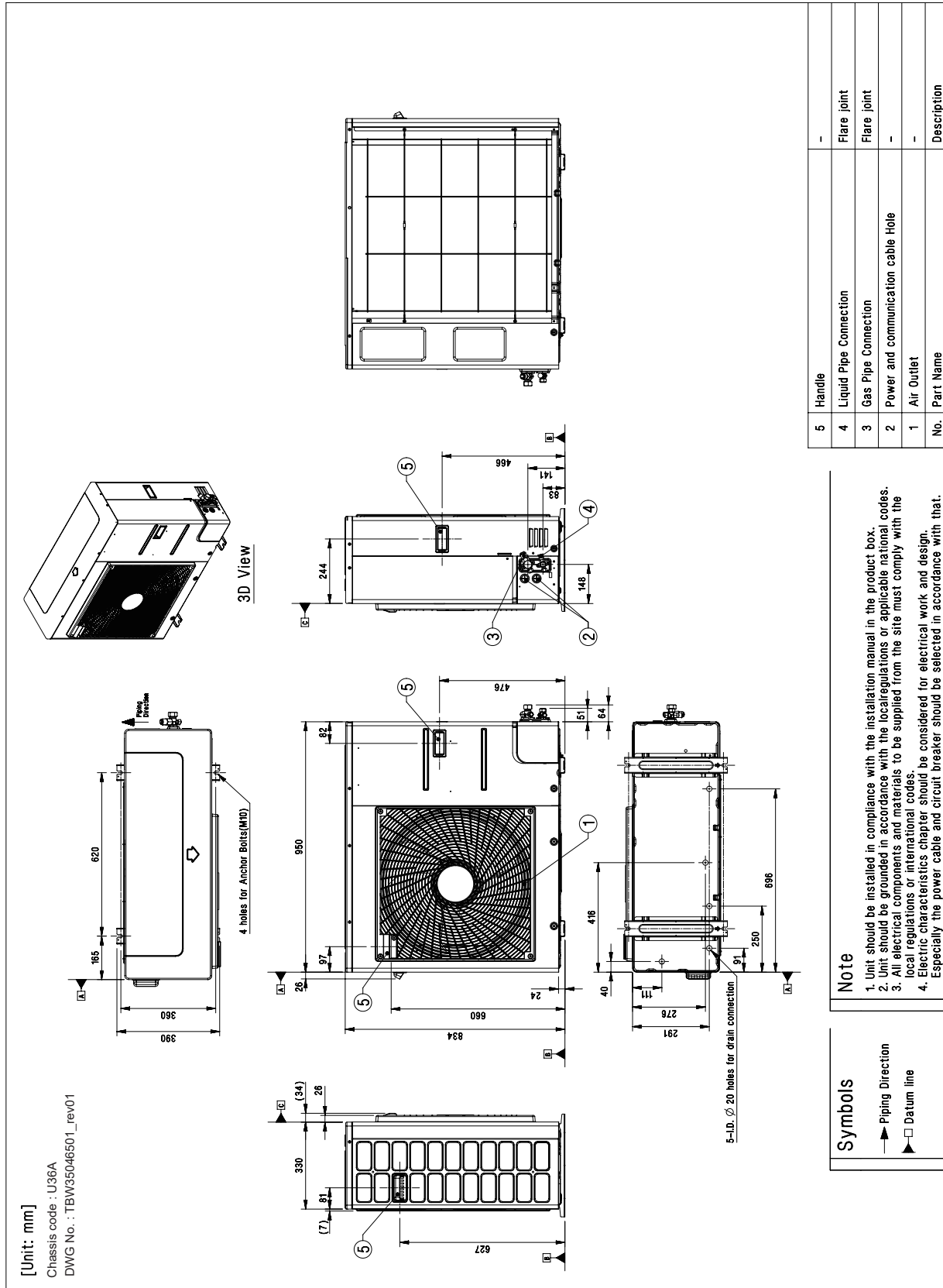

6. AVUW36GM1P1 + AVNW36GM1P1

6.4.2 Install Space

For Side Discharge (capacity < 28.0 kW)

Obstacle on the Suction side

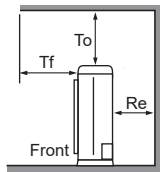

To ≥ 1,000(39-3/8)
Tf ≤ 500(19-11/16)

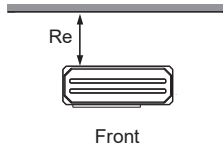

Case 1
Re ≥ 100(3-15/16)
Case 2
Re ≥ 300(11-13/16)

※ Case 1 : No obstacle on top side
Case 2 : Obstacle on top side

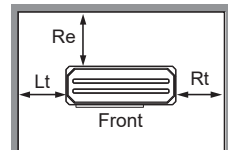

Case 1
Re ≥ 100(3-15/16)
Lt ≥ 100(3-15/16)
Rt ≥ 100(3-15/16)
Case 2
Re ≥ 300(11-13/16)
Lt ≥ 150(5-29/32)
Rt ≥ 150(5-29/32)

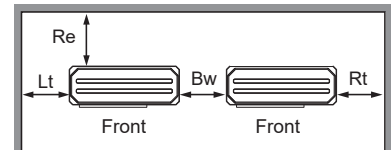

Case 1
Re ≥ 300(11-13/16)
Lt ≥ 1,000(39-3/8)
Rt ≥ 200(7-7/8)
Bw ≥ 100(3-15/16)
Case 2
Re ≥ 300(11-13/16)
Lt ≥ 1,000(39-3/8)
Rt ≥ 200(7-7/8)
Bw ≥ 100(3-15/16)

[Unit : mm(inch)]

Obstacle on the Discharge side

※ For Rear Piping / External SVC Valve type / Side-CBOX type
: Re, Lt ≥ 300(11-13/16) and Rt, Bw, Rb ≥ 600(23-5/8) for ALL CASE.

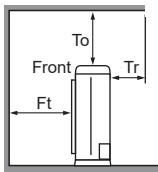
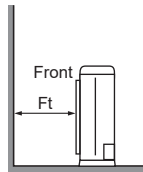

To ≥ 1,000(39-3/8)
Tr ≤ 500(19-11/16)

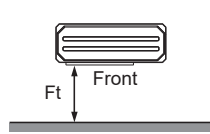

Case 1
Ft ≥ 500(19-11/16)
Case 2
Ft ≥ 500(19-11/16)

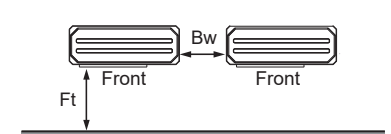

Case 1
Ft ≥ 1,000(39-3/8)
Bw ≥ 100(3-15/16)
Case 2
Ft ≥ 1,000(39-3/8)
Bw ≥ 100(3-15/16)

Obstacle on the Suction and Discharge side

Ld > H (Ls should be lower H.)

※ Close the bottom of the installation frame to prevent the discharged air from being bypassed

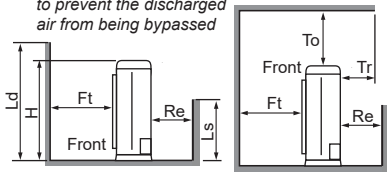

To ≥ 1,000(39-3/8)
Tf ≤ 500(19-11/16)

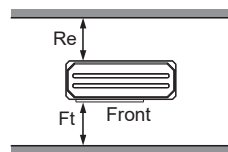

Case 1
Ft ≥ 500(19-11/16)
Re ≥ 300(11-13/16)
Case 2
Ft ≥ 1,000(39-3/8) *
Re ≥ 300(11-13/16)
* If Ls ≤ H/2,
Ft ≥ 750(29-17/32)

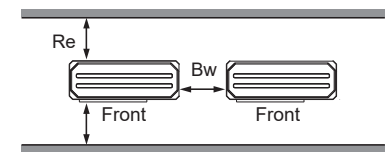

Case 1
Ft ≥ 1,000(39-3/8)
Re ≥ 300(11-13/16)
Bw ≥ 100(3-15/16)
Case 2
Ft ≥ 1,250(49-7/32)
Re ≥ 300(11-13/16)
Bw ≥ 100(3-15/16)

Ld ≤ H

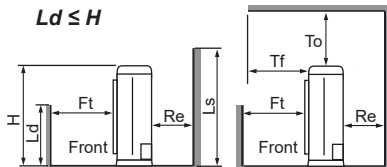

To ≥ 1,000(39-3/8)
Tf ≤ 500(19-11/16)

Case 1
Ft ≥ 500(19-11/16)
Re ≥ 300(11-13/16)
Case 2
Ft ≥ 1,000(39-3/8)
Re ≥ 300(11-13/16)

Case 1
Ft ≥ 1,500(59-1/16)
Re ≥ 300(11-13/16)
Bw ≥ 100(3-15/16)
Case 2
Ft ≥ 1,500(59-1/16)
Re ≥ 300(11-13/16)
Bw ≥ 100(3-15/16)

※ In case of series installation (2 Units or more) for 2 Fan models, Ld should be lower than H/2.

Collective/Continuous Installation (Multiple Columns)

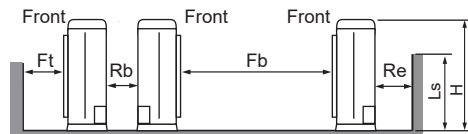

※ In case of Multiple columns/continuous installation, Ls should be lower than H.

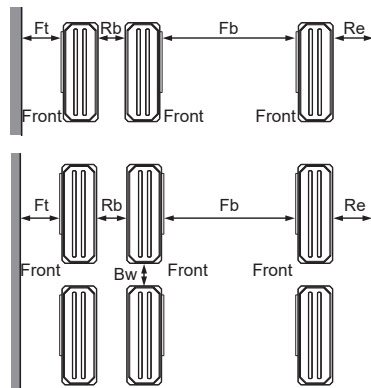

1 Column

Ft ≥ 1,000(39-3/8)
Rb ≥ 200(7-7/8)
Fb ≥ 2,000(78-3/4)
Re ≥ 100(3-15/16)

Multiple Columns

Ft ≥ 1,500(59-1/16)
Rb ≥ 600(23-5/8)
Fb ≥ 3,000(118-1/8)
Re ≥ 300(11-13/16)
Bw ≥ 100(3-15/16)

Note

- If there is a concern about product performance degradation due to group installation or interference with obstacles, secure an additional separation distance.
- Secure enough space for smooth service and maintenance.
- According to product type, model line up, sales region..etc, applicability of each chassis could be different.

6. AVUW36GM1P1 + AVNW36GM1P1

6.5 Piping Diagrams

6.5.1 Normal

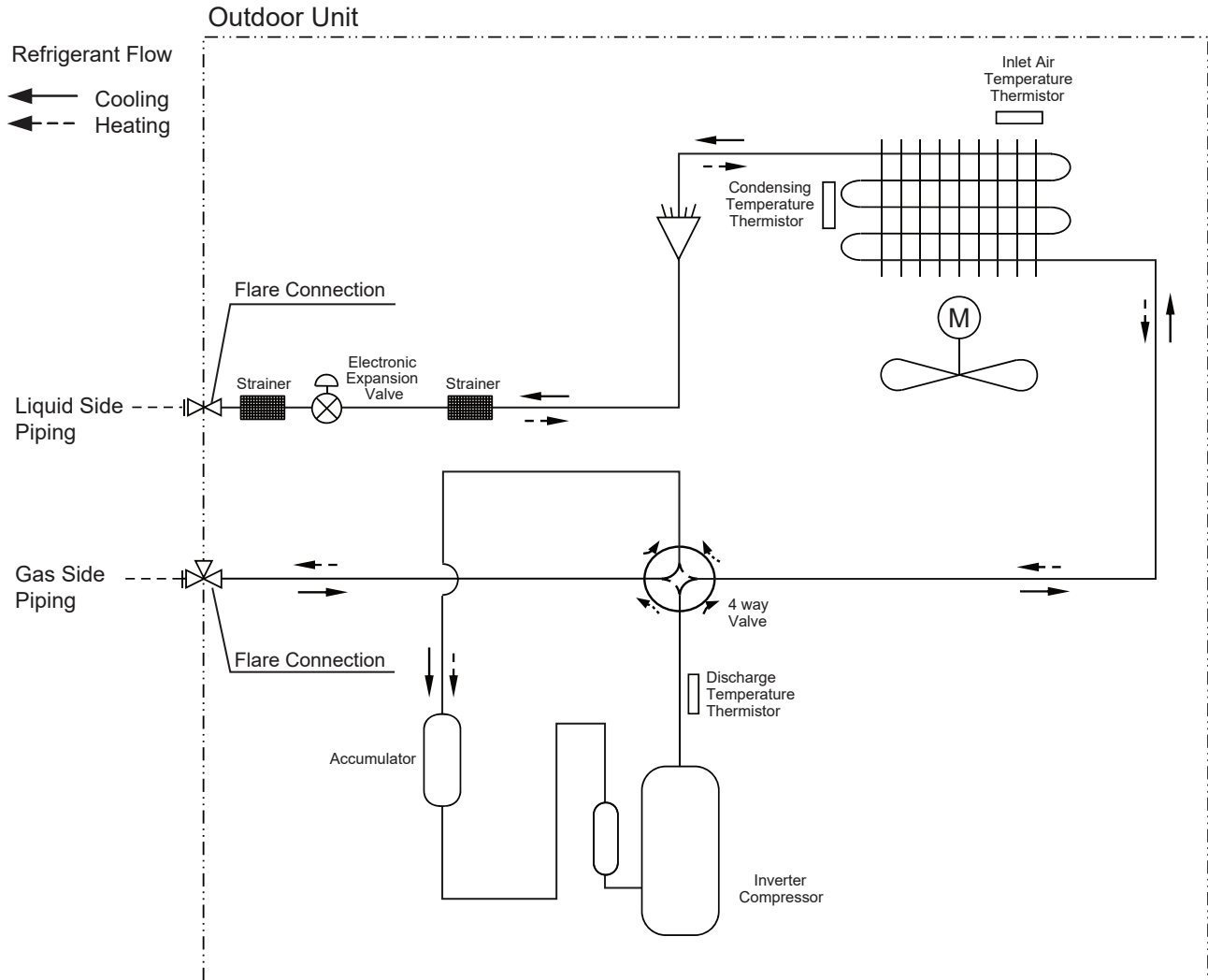

6. AVUW36GM1P1 + AVNW36GM1P1

6.6 Wiring Diagrams

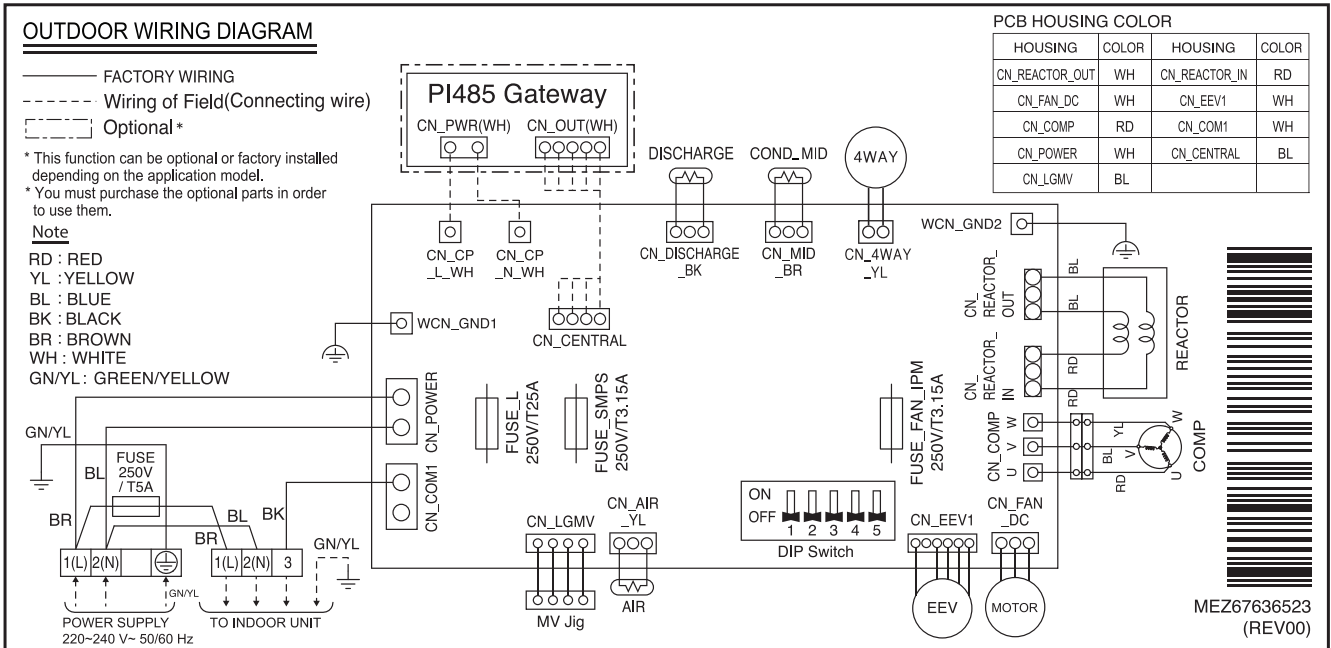

6. AVUW36GM1P1 + AVNW36GM1P1

6.7 Capacity Tables

6.7.1 Cooling

Outdoor Air Temp. (°C, DB)	Indoor Air Temp. (°C, DB/WB)																				
	20.0 / 14.0			22.0 / 16.0			25.0 / 18.0			27.0 / 19.0			28.0 / 20.0			30.0 / 22.0			32.0 / 24.0		
	TC	SHC	PI	TC	SHC	PI	TC	SHC	PI	TC	SHC	PI	TC	SHC	PI	TC	SHC	PI	TC	SHC	PI
20	5.16	4.74	1.14	6.71	5.65	1.43	7.89	6.57	1.65	8.79	7.03	1.81	9.09	6.99	1.83	9.69	6.90	1.87	10.37	6.81	1.88
25	5.16	4.74	1.34	6.71	5.65	1.68	7.89	6.57	1.95	8.79	7.03	2.14	9.09	6.99	2.16	9.69	6.90	2.20	10.37	6.81	2.22
32	5.16	4.74	1.63	6.71	5.65	2.04	7.89	6.57	2.37	8.79	7.03	2.59	9.09	6.99	2.62	9.69	6.90	2.67	10.37	6.81	2.69
35	5.16	4.74	1.75	6.71	5.65	2.20	7.89	6.57	2.54	8.79	7.03	2.79	9.09	6.99	2.82	9.69	6.90	2.87	10.37	6.81	2.89
40	5.16	4.74	2.13	6.71	5.65	2.68	7.89	6.57	3.10	8.79	7.03	3.40	9.09	6.99	3.43	9.69	6.90	3.50	10.37	6.81	3.52
43	5.16	4.74	2.36	6.71	5.65	2.96	7.89	6.57	3.43	8.79	7.03	3.77	9.09	6.99	3.81	9.69	6.90	3.88	10.37	6.81	3.90
46	5.16	4.74	2.62	6.71	5.65	3.28	7.51	6.30	3.52	7.67	6.20	3.59	7.93	6.16	3.63	8.45	6.07	3.70	9.05	5.98	3.72
48	5.16	4.74	2.90	6.71	5.65	3.29	7.14	5.99	3.36	7.29	5.94	3.42	7.50	5.86	3.46	7.91	5.71	3.53	8.38	5.57	3.55
50	5.16	4.74	3.07	6.71	5.65	3.13	6.77	5.68	3.19	6.91	5.67	3.26	7.06	5.56	3.29	7.36	5.35	3.36	7.72	5.15	3.38
52	5.16	4.74	2.91	6.27	5.34	2.97	6.40	5.43	3.03	6.53	5.40	3.09	6.63	5.26	3.12	6.82	4.98	3.19	7.06	4.73	3.21
54	5.16	4.74	2.76	5.91	5.09	2.81	6.03	5.17	2.87	6.15	5.13	2.93	6.19	4.96	2.96	6.28	4.61	3.02	6.40	4.31	3.04

Note

- DB : Dry bulb temperature(°C), WB : Wet bulb temperature(°C)
- TC : Total Capacity(kW), SHC : Sensible Heat Capacity(kW)
- PI : Power Input (kW, Compressor + indoor fan motor + outdoor fan motor)
- All capacities are net. A deduction of capacity due to operating heat of indoor unit motor is reflected.
- Direct interpolation is permissible. Do not extrapolate.
- Rated capacities and power inputs are based on standard temperature and piping conditions, and it can be found on specifications table.
Except for rated value, the performance is not guaranteed.
- In accordance with the test standard(or nations), the rating will vary slightly.

6. AVUW36GM1P1 + AVNW36GM1P1

6.7.2 Heating

Outdoor Air Temp. (°C, WB)	Indoor Air Temp. (°C, DB)									
	16.0		18.0		20.0		22.0		24.0	
	TC	PI	TC	PI	TC	PI	TC	PI	TC	PI
-5.0	9.07	2.64	9.02	2.90	8.97	3.15	8.93	3.41	8.88	3.66
0.0	10.07	3.15	10.02	3.41	9.97	3.66	9.57	3.45	9.17	3.24
6.0	11.04	3.36	10.50	3.20	9.97	3.05	9.57	2.90	9.17	2.75
10.0	11.04	3.15	10.50	2.90	9.97	2.64	9.57	2.53	9.17	2.41
15.0	11.04	2.64	10.50	2.39	9.97	2.14	9.57	2.07	9.17	2.00
18.0	11.04	2.34	10.50	2.08	9.97	1.83	9.57	1.79	9.17	1.75

Note

- DB : Dry bulb temperature(°C), WB : Wet bulb temperature(°C)
- TC : Total Capacity(kW)
- PI : Power Input (kW, Compressor + indoor fan motor + outdoor fan motor)
- All capacities are net. An addition of capacity due to operating heat of indoor unit motor is reflected.
- Direct interpolation is permissible. Do not extrapolate.
- Rated capacities and power inputs are based on standard temperature and piping conditions, and it can be found on specifications table.
Except for rated value, the performance is not guaranteed.
- In accordance with the test standard(or nations), the rating will vary slightly.

6. AVUW36GM1P1 + AVNW36GM1P1

6.8 Capacity Correction Factor

Operation	Capacity correction factor (%) by Equivalent pipe length (m)										
	5	7.5	10	15	20	25	30	35	40	45	50
Cooling	100.0	99.6	99.3	97.9	96.6	95.2	93.8	92.4	91.1	89.8	88.4
Heating	100.0	99.9	99.7	99.2	98.7	98.2	97.7	97.1	96.6	96.1	95.6

Note

In Order to estimate the actual system capacity, the influence of various installation conditions should be reflected.

Reflect the capacity correction factor effect of piping installation as below.

- Qodu [from specification table] : Outdoor unit standard capacity.
- Q(Ti, To) [from capacity table] : Outdoor unit capacity at Ti, To temperature.
- F(Ti, To) = Q(Ti, To) / Qodu. : Outdoor unit capacity correction factor
- Fpiping for piping length [from capacity correction factor table] : Piping correction factor
- Indoor unit actual capacity : Qactual = Qodu x F(Ti, To) x Fpiping

6. AVUW36GM1P1 + AVNW36GM1P1

6.9 Operation Limits

6.9.1 Cooling

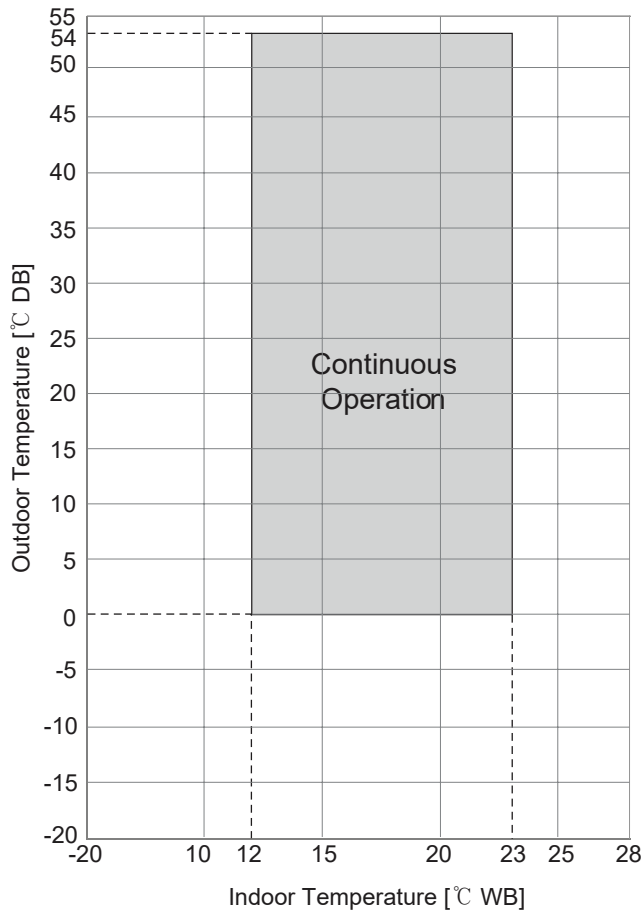

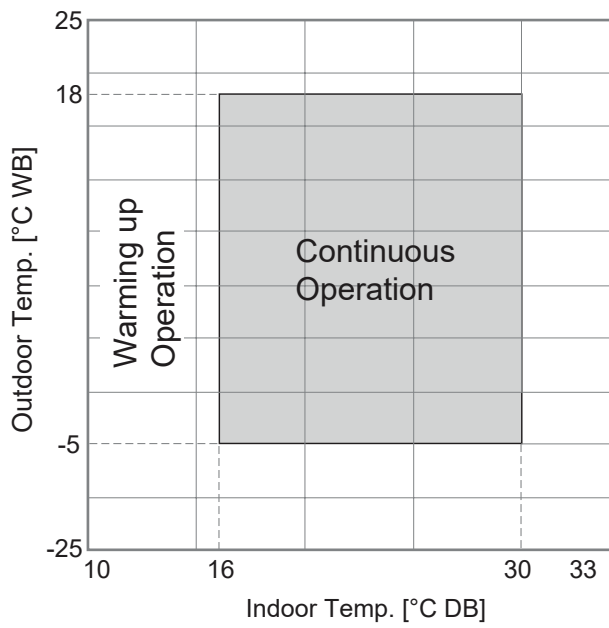
6. AVUW36GM1P1 + AVNW36GM1P1**6.9.2 Heating****Note**

- Warming up operation and operative mean that the outdoor unit operates to reach the range of continuous operating, however it may not operate continuously due to safety or protection logic.

6. AVUW36GM1P1 + AVNW36GM1P1

6.10 Sound Levels

6.10.1 Pressure Levels

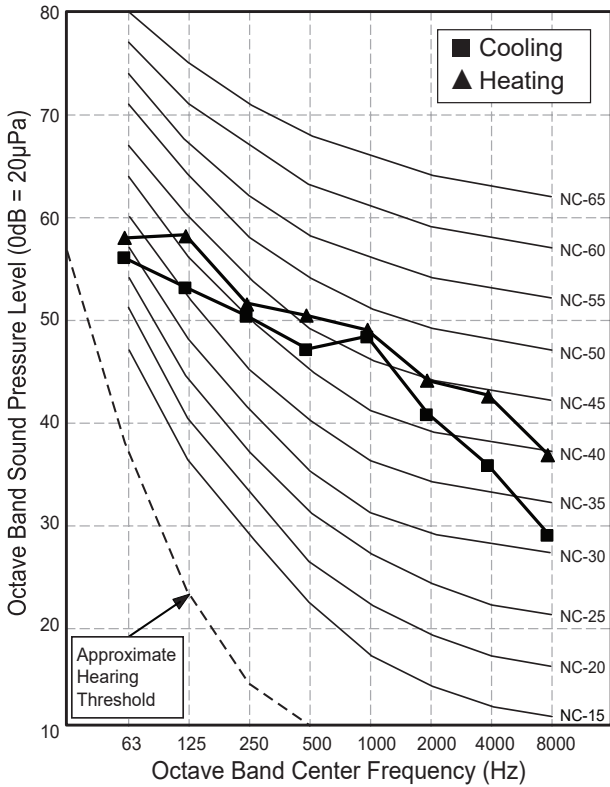

Sound level [dB(A), @ Standard condition]	
Cooling / Heating (@ 1.5m height)	51.0 / 53.0

Note

- Data is valid at diffuse field condition.
- Data is valid at nominal operating condition. Refer to the model specifications for nominal conditions.(Power source and Ambient temperature, etc)
- Reference acoustic pressure $0dB = 20\mu Pa$.
- Sound levels can be increased in accordance with installation and operating conditions. (Operating conditions include some functional condition like Static pressure mode, air guide use, Room target temperature setting, etc and these functions are different in accordance with each model.)
- Sound level will vary depending on a range of factors such as the construction(acoustic absorption coefficient) of particular room in which the equipment in installed.
- Sound pressure level is measured on the rated condition in the anechoic rooms by ISO 3745 Standard. Therefore, these values can be increased owing to ambient conditions during operation.

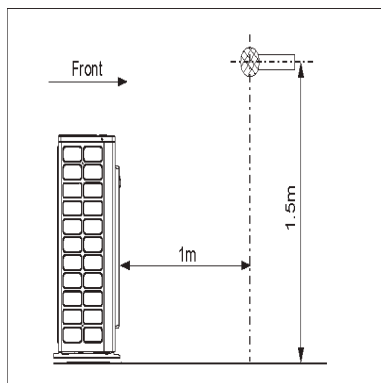

7. ATUW48GMLP1 + ATNW48GMLP1

7.1 Specifications

Category		Unit	Specification
Major	Minor		
Classification	Chassis	-	U60
	Cooling / Heating	-	H/P
Power Supply	Case 1	-	220, 1, 60
	Case 2	-	-
	Limit Range of Voltage(Case 1)	V	198 ~ 242
	Limit Range of Voltage(Case 2)	V	-
Cooling Capacity	Rated	kW	13.78
		Btu/h	47,000
	Min ~ Max	kW	5.37~15.50
		Btu/h	18,400~53,000
	Sensible	kW	10.60
		Btu/h	36,200
Heating Capacity	Rated	kW	15.30
		Btu/h	53,000
	Min ~ Max	kW	5.61~15.80
		Btu/h	19,200~54,000
Power Input(Cooling)	Rated	kW	4.25
	Min ~ Max	kW	~-~
Power Input(Heating)	Rated	kW	4.35
	Min ~ Max	kW	~-~
Efficiency	EER	W/W	3.28
	COP	W/W	3.57
	SEER	Wh/Wh	6.39
Running Current(Cooling)	Rated	A	19.10
	Min/Max	A	- / -
Running Current(Heating)	Rated	A	19.80
	Min/Max	A	- / -
Running Current	Max	A	27.00
Power Factor(Cooling/Heating)	Rated	-	0.99 / 0.99
Outdoor Fan	Type	-	Propeller
	Air Flow Rate(Max)	m ³ /min x No.	60 x 2
	Max. External Static Pressure	Pa	-
Outdoor Fan Motor	Type	-	BLDC
	Drive	-	-
	Output	W x No.	124.2 x 2
Compressor	Type	-	Twin Rotary
	Model x No.	-	GPT442MAB x 1
	Motor Type	-	BLDC
	Motor Output	W x No.	4,000 x 1
	Oil Type	-	PVE
	Oil Charging amount	cc x No.	1,300 x 1
Heat Exchanger	Rows x Columns x FPI	-	2 x 32 x 14
	No.	-	2
	Fin Type	-	Wide Louver Plus
	Corrosion Protection (Coating)	-	-
	Material (Tube / Fin)	-	-
	Face Area	m ²	-
Dimensions	Net(W x H x D)	mm	950 x 1,380 x 330
	Shipping(W x H x D)	mm	1,140 x 1,462 x 461
Weight	Net	kg	91.3

7. ATUW48GMLP1 + ATNW48GMLP1

Category		Unit	Specification
Major	Minor		
Weight	Shipping	kg	101.3
Exterior	Color	-	Warm Gray
	RAL (Classic)	-	RAL 7044
Protection Device	High Pressure Prevention	-	-
	Frost Prevention	-	-
	Discharge Temperature Control	-	-
	Inverter Protection	-	-
Refrigerant	Type	-	R410A
	Precharged Amount	kg	3.400
	Additional Charging amount	g/m	40
	GWP(Global Warming Potential)	-	2,087.5
	t-CO ₂ eq.	-	7.098
	Chargeless-Pipe Length	m	7.5
	Control Type	-	EEV
Connecting Pipe	Liquid	mm(inch)	Φ9.52 (3/8)
	Gas	mm(inch)	Φ19.05 (3/4)
Pipe Connecting Socket	Liquid	mm(inch)	Φ9.52 (3/8)
	Gas	mm(inch)	Φ19.05 (3/4)
	Connection Type(Liquid)	-	Flare
	Connection Type(Gas)	-	Flare
Piping Length Limit	IDU - ODU(Rated / Max / Min)	m	5 / 50 / 5
Maximum Height Difference	IDU - ODU(Max)	m	30
Sound Pressure Level (Outdoor Unit)	Cooling / Heating (@ 1.5m height)	dB(A)	55.0 / 57.0
Measurement Standard (Pressure Level)	-	-	ISO 3745
Sound Power Level (Outdoor Unit)	Cooling / Heating	dB(A)	-
Measurement Standard (Power Level)	-	-	-
Connecting Cable	Power Supply Cable(H07RN-F)	mm ² × cores	6.0 x 3C
Electrical Characteristic	Minimum Circuit Amperes (MCA)	A	34.3
	Maximum Fuse Amperes (MFA)	A	40
	Comp_Rated Load Amperes (Max)	A	25.6
	Outdoor Fan Motor_Full Load Amperes (FLA)	A	1.02

Note

- Due to our policy of innovation some specifications may be changed without notification.
- Wiring cable size must comply with the applicable local and national codes. And "Electric characteristics" should be considered for electrical work and design. Especially the power cable and circuit breaker should be selected in accordance with that.
- Power factor could vary less than ±1% according to the operating conditions.
- Sound level values are depend on the ambient conditions and values are normally higher in actual operation.
- This product contains Fluorinated greenhouse gases.
- Voltage supplied to the unit terminals should be within the minimum and maximum range.
- Maximum allowable voltage unbalance between phase is 2%.
- MSC means the Max. current during the starting of compressor.
- MSC and RLA are measured as the compressor only test condition.
- OFM and IFM are measured as the outdoor unit test condition.
- Select the wire size based on MCA.
- MFA is used to select the circuit breaker and ground fault circuit interrupter, and all installation site must require attachment of an earth leakage breaker. [circuit breaker type is ELCB(Earth Leakage Circuit Breaker)].
- Performances are based on the following conditions :
 - Cooling : Indoor Ambient Temp. 27°CDB / 19°CWB, Outdoor Ambient Temp. 35°CDB / 24°CWB
 - Heating : Indoor Ambient Temp. 20°CDB / 15°CWB, Outdoor Ambient Temp. 7°CDB / 6°CWB
 - Interconnected Pipe Length is standard length and difference of Elevation (Outdoor ~ Indoor Unit) is 0m.

7. ATUW48GMLP1 + ATNW48GMLP1**7.2 List of Functions**

Category	Functions	Availability
Reliability	Defrost / Deicing	O
	High Pressure Switch	X
	Low Pressure Switch	X
	Phase Protection	X
	Restart Delay (3-minutes)	O
	Self Diagnosis	O
	Soft Start	O
Convenience	Night Low Noise Operation	O
	Wiring Error Check	X
	Peak Control	O
	Mode Lock	O
	Forced Cooling Operation (Outdoor Unit)	X
	Advanced SLC (Smart Load Control)	X
Special Functions	ODU Dry Contact Function	X

Note

■ O : Applied, X : Not applied

- Accessory : Ordered and purchased separately the accessory package referring to the model name provided and install at field.
- Accessory line-ups varies by region, so check your local catalogue or local sales material.

7. ATUW48GMLP1 + ATNW48GMLP1

7.3 Accessory Compatibility List

Category	Accessory Name	Model Name	Description	Compatibility
Central Controller	AC EZ	PQCSZ250S0	-	O
	AC EZ touch	PACEZA000	Touch type	O
	AC Smart IV	PACS4B000	Touch type	O
	AC Smart 5	PACS5A000	Touch type	O
	ACP IV	PACP4B000	-	O
	ACP 5	PACP5A000	-	O
	AC Manager IV	PACM4B000	For Integrated Control	O
	AC Manager 5	PACM5A000	For Integrated Control	O
Gateway	ODU PI485	PMNFP14A1	For 16-room (3 series)	O
	ACP BACnet	PQNFB17C0	-	O
	ACP Lonwork	PLNWKB000	-	O
	Cloud Gateway	PWFMDB200	-	O
Integration Device	AHU comm. kit	PAHCMR000	For AHU Control (Multi V / Single ODU Communication)	O
		PAHCMS000	For AHU Control (Multi V / Single ODU Communication)	X
	AHU Controller Module	PAHCMC000	For AHU Control (Communication Module)	X
		PAHCMM000	For AHU Control (Main Module)	X
	PDI Standard	PPWRDB000	Power distributor 2port	X
	PDI Premium	PQNUD1S40	Power distributor 8port	X

Note

- O: Possible, X: Impossible, -: Unconfirmed or irrelevant
- AC Manager requires ACP or AC Smart.
- Compatibility of individual controller(wireless/wired remote controller) could be found with function list on Indoor Unit's PDB.
- If you need more detail, please refer to the Control(BECON) PDB or the manual of product.
(<http://partner.lge.com/global> : Home> Doc.Library> Product > Control(BECON)).
- Accessory line-ups varies by region, so check your local catalogue or local sales material.

7. ATUW48GMLP1 + ATNW48GMLP1

7.4 Dimensions

7.4.1 Product

[Unit: mm]

Chassis code : U60A
DWG No. : TBA36228001_rev01

Gravity point

3D View

Front View
 Dimensions: 1980 (total width), 1254 (main width), 950 (height), 90 (top offset), 397 (bottom offset), 550 (fan width), 24 (fan offset), 416 (total depth), 291 (main depth), 111 (fan offset), 276 (fan depth), 91 (fan offset), 250 (fan depth), 696 (total depth).
 Callouts: 1 (fan), 2 (fan), 3 (fan), 4 (fan), 5 (fan)

Top View
 Dimensions: 620 (width), 390 (main width), 390 (main width), 165 (offset), 4 holes for Anchor Bolts (M10), Piping Direction arrow.

Side View
 Dimensions: 330 (width), 33 (top offset), 25 (bottom offset).
 Callout: B (datum line)

Bottom View
 Dimensions: 606 (width), 541 (main width), 51 (offset), 72 (offset).
 Callouts: 1 (fan), 2 (fan), 3 (fan), 4 (fan), 5 (fan)

Internal View
 Dimensions: 416 (total depth), 291 (main depth), 111 (fan offset), 276 (fan depth), 91 (fan offset), 250 (fan depth), 696 (total depth).
 Callout: 5-ID, \varnothing 20 holes for drain connection

Note

- Unit should be installed in compliance with the installation manual in the product box.
- Unit should be grounded in accordance with the local regulations or applicable national codes.
- All electrical components and materials to be supplied from the site must comply with the local regulations or international codes.
- Electric characteristics chapter should be considered for electrical work and design. Especially the power cable and circuit breaker should be selected in accordance with that.

Symbols

- Piping Direction
- Datum line

7. ATUW48GMLP1 + ATNW48GMLP1

7.4.2 Install Space

For Side Discharge (capacity < 28.0 kW)

Obstacle on the Suction side

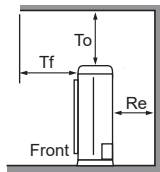

To ≥ 1,000(39-3/8)
Tf ≤ 500(19-11/16)

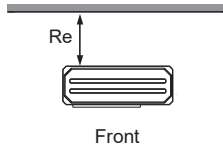

Case 1
Re ≥ 100(3-15/16)
Case 2
Re ≥ 300(11-13/16)

※ Case 1 : No obstacle on top side
Case 2 : Obstacle on top side

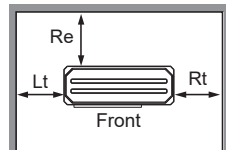

Case 1
Re ≥ 100(3-15/16)
Lt ≥ 100(3-15/16)
Rt ≥ 100(3-15/16)
Case 2
Re ≥ 300(11-13/16)
Lt ≥ 150(5-29/32)
Rt ≥ 150(5-29/32)

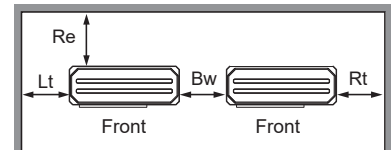

Case 1
Re ≥ 300(11-13/16)
Lt ≥ 1,000(39-3/8)
Rt ≥ 200(7-7/8)
Bw ≥ 100(3-15/16)
Case 2
Re ≥ 300(11-13/16)
Lt ≥ 1,000(39-3/8)
Rt ≥ 200(7-7/8)
Bw ≥ 100(3-15/16)

[Unit : mm(inch)]

Obstacle on the Discharge side

※ For Rear Piping / External SVC Valve type / Side-CBOX type
: Re, Lt ≥ 300(11-13/16) and Rt, Bw, Rb ≥ 600(23-5/8) for ALL CASE.

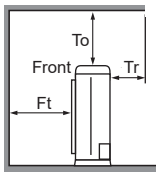
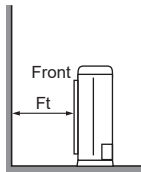

To ≥ 1,000(39-3/8)
Tr ≤ 500(19-11/16)

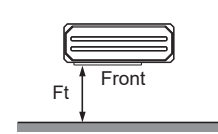

Case 1
Ft ≥ 500(19-11/16)
Case 2
Ft ≥ 500(19-11/16)

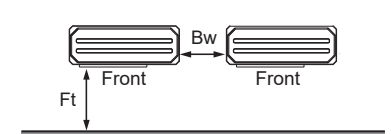

Case 1
Ft ≥ 1,000(39-3/8)
Bw ≥ 100(3-15/16)
Case 2
Ft ≥ 1,000(39-3/8)
Bw ≥ 100(3-15/16)

Obstacle on the Suction and Discharge side

Ld > H (Ls should be lower H.)

※ Close the bottom of the installation frame to prevent the discharged air from being bypassed

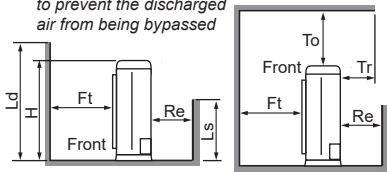

To ≥ 1,000(39-3/8)
Tf ≤ 500(19-11/16)

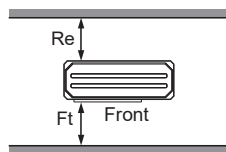

Case 1
Ft ≥ 500(19-11/16)
Re ≥ 300(11-13/16)
Case 2
Ft ≥ 1,000(39-3/8) *
Re ≥ 300(11-13/16)
* If Ls ≤ H/2,
Ft ≥ 750(29-17/32)

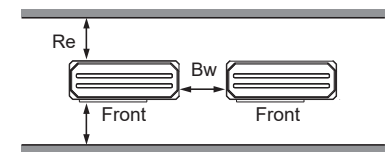

Case 1
Ft ≥ 1,000(39-3/8)
Re ≥ 300(11-13/16)
Bw ≥ 100(3-15/16)
Case 2
Ft ≥ 1,250(49-7/32)
Re ≥ 300(11-13/16)
Bw ≥ 100(3-15/16)

Ld ≤ H

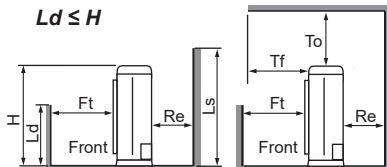

To ≥ 1,000(39-3/8)
Tf ≤ 500(19-11/16)

Case 1
Ft ≥ 500(19-11/16)
Re ≥ 300(11-13/16)
Case 2
Ft ≥ 1,000(39-3/8)
Re ≥ 300(11-13/16)

Case 1
Ft ≥ 1,500(59-1/16)
Re ≥ 300(11-13/16)
Bw ≥ 100(3-15/16)
Case 2
Ft ≥ 1,500(59-1/16)
Re ≥ 300(11-13/16)
Bw ≥ 100(3-15/16)

※ In case of series installation (2 Units or more) for 2 Fan models, Ld should be lower than H/2.

Collective/Continuous Installation (Multiple Columns)

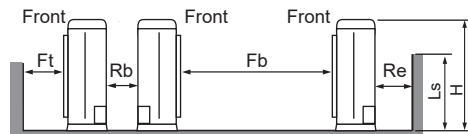

※ In case of Multiple columns/continuous installation, Ls should be lower than H.

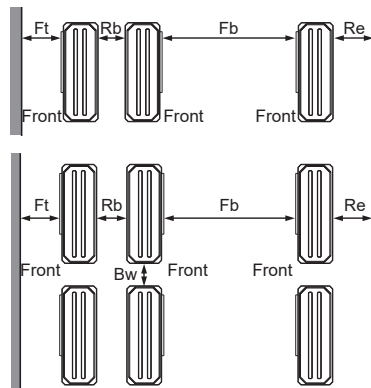

1 Column

Ft ≥ 1,000(39-3/8)
Rb ≥ 200(7-7/8)
Fb ≥ 2,000(78-3/4)
Re ≥ 100(3-15/16)

Multiple Columns

Ft ≥ 1,500(59-1/16)
Rb ≥ 600(23-5/8)
Fb ≥ 3,000(118-1/8)
Re ≥ 300(11-13/16)
Bw ≥ 100(3-15/16)

Note

- If there is a concern about product performance degradation due to group installation or interference with obstacles, secure an additional separation distance.
- Secure enough space for smooth service and maintenance.
- According to product type, model line up, sales region..etc, applicability of each chassis could be different.

7. ATUW48GMLP1 + ATNW48GMLP1

7.5 Piping Diagrams

7.5.1 Normal

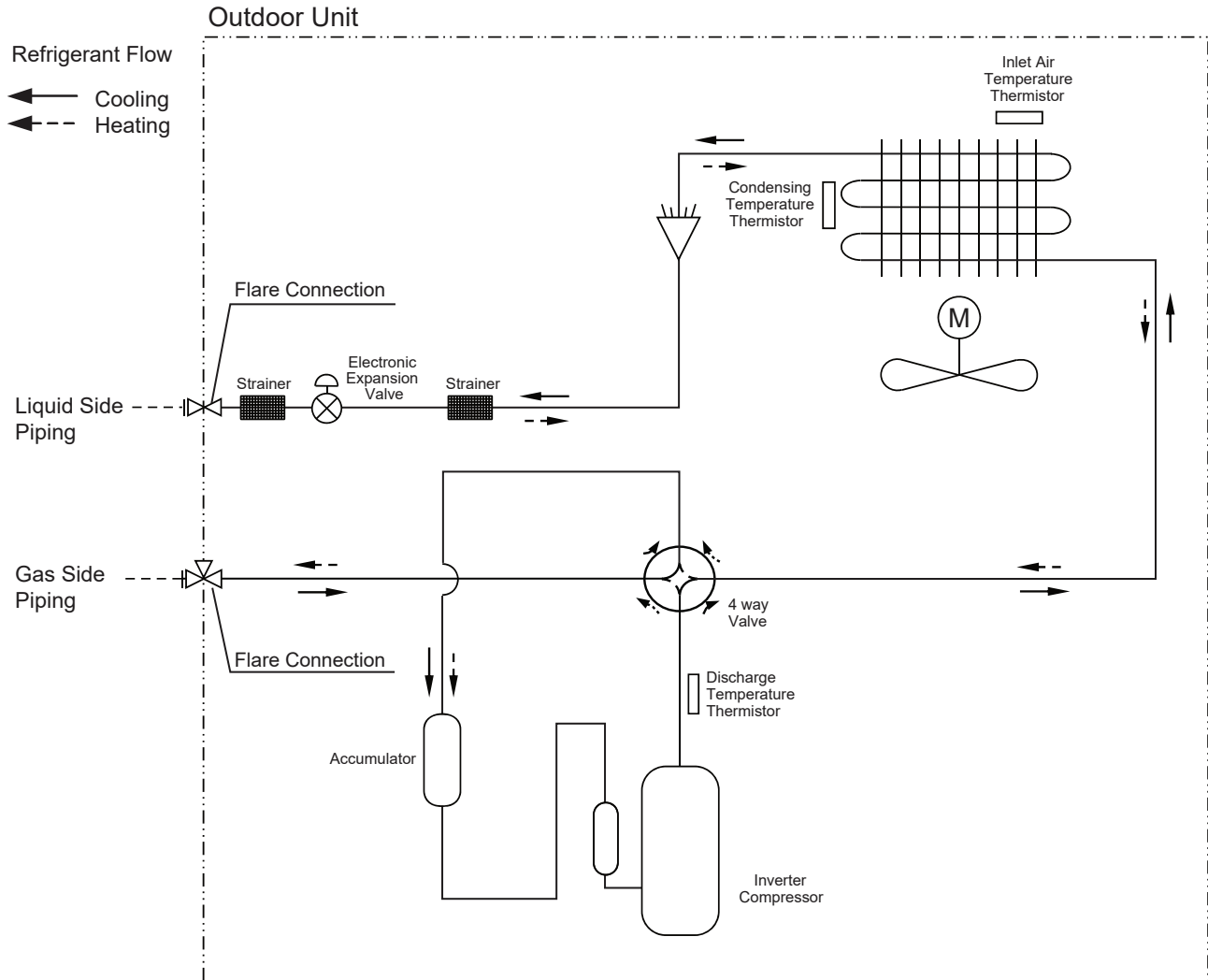

7. ATUW48GMLP1 + ATNW48GMLP1

7.6 Wiring Diagrams

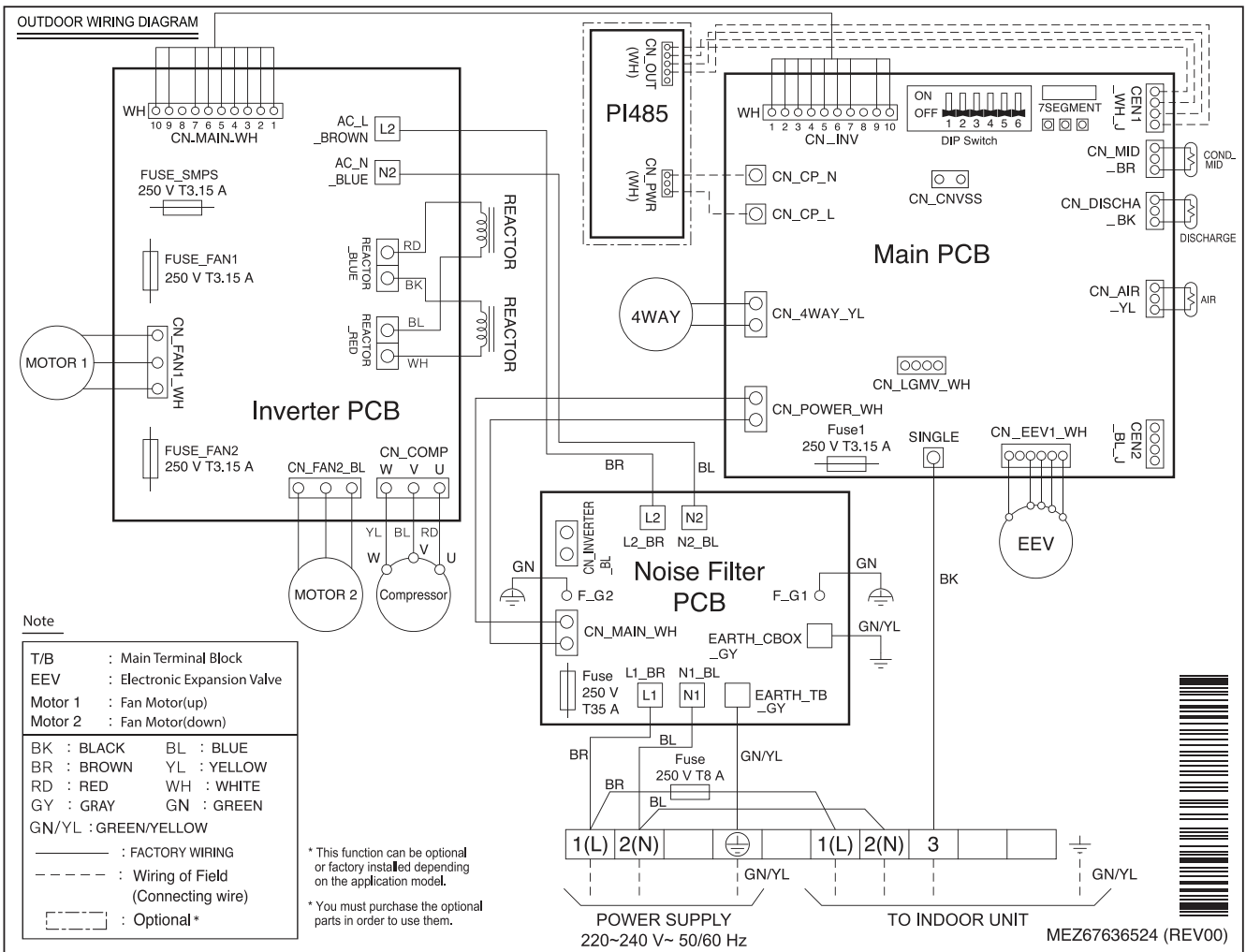

7. ATUW48GMLP1 + ATNW48GMLP1

7.7 Capacity Tables

7.7.1 Cooling

Outdoor Air Temp. (°C, DB)	Indoor Air Temp. (°C, DB/WB)																				
	20.0 / 14.0			22.0 / 16.0			25.0 / 18.0			27.0 / 19.0			28.0 / 20.0			30.0 / 22.0			32.0 / 24.0		
	TC	SHC	PI	TC	SHC	PI	TC	SHC	PI	TC	SHC	PI	TC	SHC	PI	TC	SHC	PI	TC	SHC	PI
20	8.09	7.14	1.73	10.52	8.53	2.17	12.37	9.91	2.52	13.78	10.60	2.76	14.25	10.53	2.79	15.19	10.40	2.84	16.26	10.27	2.86
25	8.09	7.14	2.04	10.52	8.53	2.56	12.37	9.91	2.97	13.78	10.60	3.26	14.25	10.53	3.29	15.19	10.40	3.36	16.26	10.27	3.37
32	8.09	7.14	2.48	10.52	8.53	3.11	12.37	9.91	3.60	13.78	10.60	3.95	14.25	10.53	3.99	15.19	10.40	4.07	16.26	10.27	4.09
35	8.09	7.14	2.66	10.52	8.53	3.34	12.37	9.91	3.87	13.78	10.60	4.25	14.25	10.53	4.29	15.19	10.40	4.38	16.26	10.27	4.40
40	8.09	7.14	2.86	10.52	8.53	3.60	12.37	9.91	4.17	13.78	10.60	4.57	14.25	10.53	4.62	15.19	10.40	4.71	16.26	10.27	4.73
43	8.09	7.14	2.98	10.52	8.53	3.75	12.37	9.91	4.34	13.78	10.60	4.76	14.25	10.53	4.81	15.19	10.40	4.90	16.26	10.27	4.93
46	8.09	7.14	3.11	10.52	8.53	3.90	11.22	9.05	4.40	11.45	8.90	4.49	11.84	8.84	4.54	12.62	8.71	4.63	13.51	8.59	4.65
48	8.09	7.14	3.24	10.52	8.53	4.07	10.78	8.69	4.29	11.00	8.62	4.38	11.31	8.51	4.42	11.92	8.28	4.51	12.64	8.07	4.53
50	8.09	7.14	3.37	10.13	8.30	4.09	10.34	8.43	4.18	10.55	8.33	4.26	10.78	8.17	4.30	11.23	7.84	4.39	11.77	7.55	4.42
52	8.09	7.14	3.52	9.70	8.03	3.99	9.90	8.16	4.07	10.10	8.03	4.15	10.24	7.82	4.19	10.53	7.40	4.28	10.90	7.03	4.30
54	8.09	7.14	3.66	9.26	7.76	3.88	9.45	7.88	3.96	9.65	7.73	4.04	9.71	7.47	4.08	9.84	6.95	4.16	10.04	6.49	4.18

Note

- DB : Dry bulb temperature(°C), WB : Wet bulb temperature(°C)
- TC : Total Capacity(kW), SHC : Sensible Heat Capacity(kW)
- PI : Power Input (kW, Compressor + indoor fan motor + outdoor fan motor)
- All capacities are net. A deduction of capacity due to operating heat of indoor unit motor is reflected.
- Direct interpolation is permissible. Do not extrapolate.
- Rated capacities and power inputs are based on standard temperature and piping conditions, and it can be found on specifications table.
Except for rated value, the performance is not guaranteed.
- In accordance with the test standard(or nations), the rating will vary slightly.

7. ATUW48GMLP1 + ATNW48GMLP1

7.7.2 Heating

Outdoor Air Temp. (°C, WB)	Indoor Air Temp. (°C, DB)									
	16.0		18.0		20.0		22.0		24.0	
	TC	PI	TC	PI	TC	PI	TC	PI	TC	PI
-5.0	13.92	3.77	13.85	4.13	13.77	4.50	13.70	4.86	13.63	5.22
0.0	15.45	4.50	15.38	4.86	15.30	5.22	14.69	4.92	14.08	4.63
6.0	16.94	4.79	16.12	4.57	15.30	4.35	14.69	4.13	14.08	3.92
10.0	16.94	4.50	16.12	4.13	15.30	3.77	14.69	3.61	14.08	3.44
15.0	16.94	3.77	16.12	3.41	15.30	3.05	14.69	2.95	14.08	2.85
18.0	16.94	3.34	16.12	2.97	15.30	2.61	14.69	2.55	14.08	2.49

Note

- DB : Dry bulb temperature(°C), WB : Wet bulb temperature(°C)
- TC : Total Capacity(kW)
- PI : Power Input (kW, Compressor + indoor fan motor + outdoor fan motor)
- All capacities are net. An addition of capacity due to operating heat of indoor unit motor is reflected.
- Direct interpolation is permissible. Do not extrapolate.
- Rated capacities and power inputs are based on standard temperature and piping conditions, and it can be found on specifications table.
Except for rated value, the performance is not guaranteed.
- In accordance with the test standard(or nations), the rating will vary slightly.

7. ATUW48GMLP1 + ATNW48GMLP1

7.8 Capacity Correction Factor

Operation	Capacity correction factor (%) by Equivalent pipe length (m)										
	5	7.5	10	15	20	25	30	35	40	45	50
Cooling	100.0	99.6	99.3	97.9	96.6	95.2	93.8	92.4	91.1	89.8	88.4
Heating	100.0	99.9	99.7	99.2	98.7	98.2	97.7	97.1	96.6	96.1	95.6

Note

In Order to estimate the actual system capacity, the influence of various installation conditions should be reflected.

Reflect the capacity correction factor effect of piping installation as below.

- Qodu [from specification table] : Outdoor unit standard capacity.
- Q(Ti, To) [from capacity table] : Outdoor unit capacity at Ti, To temperature.
- F(Ti, To) = Q(Ti, To) / Qodu. : Outdoor unit capacity correction factor
- Fpiping for piping length [from capacity correction factor table] : Piping correction factor
- Indoor unit actual capacity : Qactual = Qodu x F(Ti, To) x Fpiping

7. ATUW48GMLP1 + ATNW48GMLP1

7.9 Operation Limits

7.9.1 Cooling

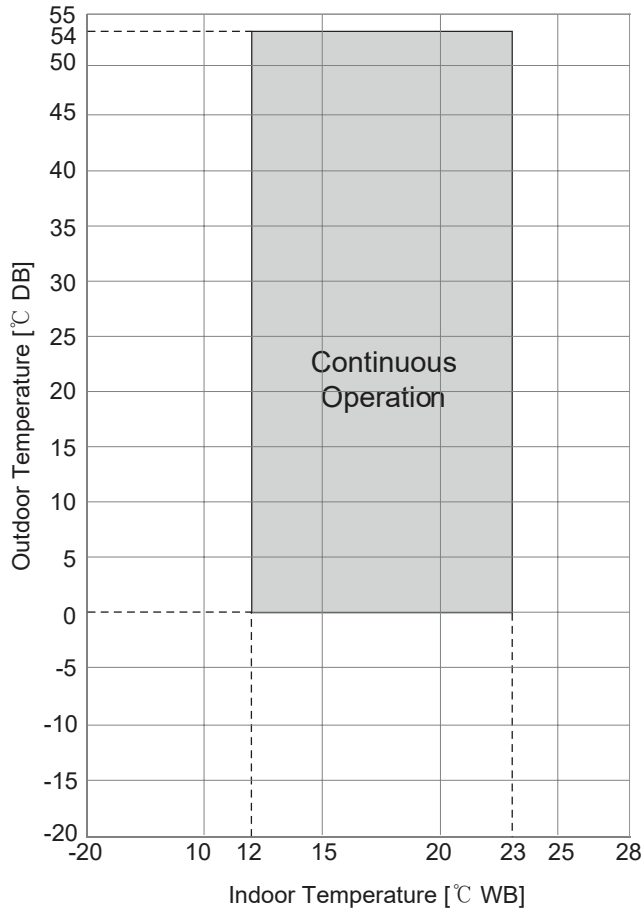

7. ATUW48GMLP1 + ATNW48GMLP1

7.9.2 Heating

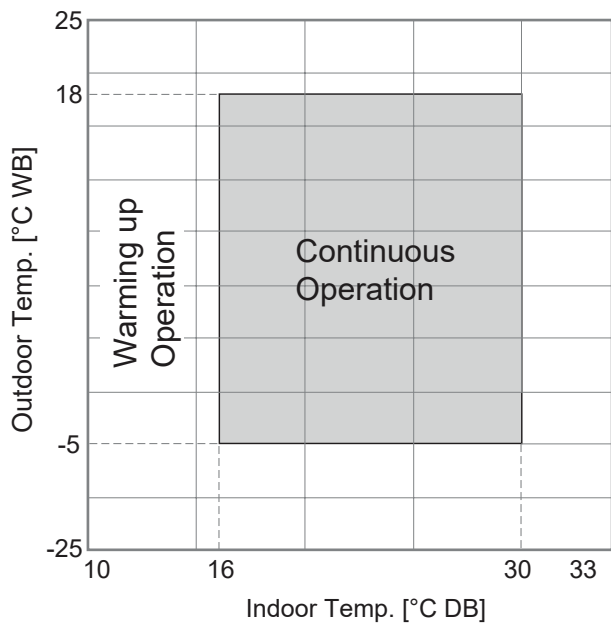

Note

- Warming up operation and operative mean that the outdoor unit operates to reach the range of continuous operating, however it may not operate continuously due to safety or protection logic.

7. ATUW48GMLP1 + ATNW48GMLP1

7.10 Sound Levels

7.10.1 Pressure Levels

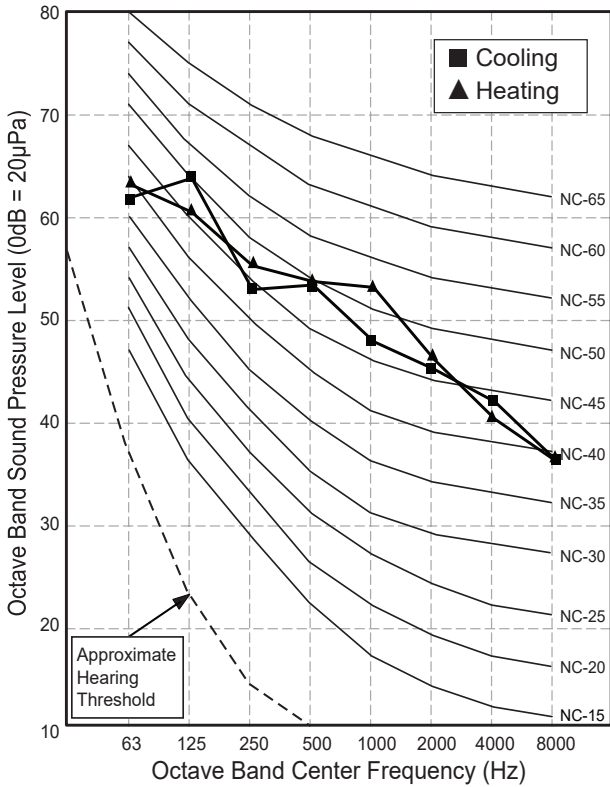

Sound level [dB(A), @ Standard condition]	
Cooling / Heating (@ 1.5m height)	55.0 / 57.0

Note

- Data is valid at diffuse field condition.
- Data is valid at nominal operating condition.
- Reference acoustic pressure 0dB = 20µPa.
- Refer to the model specifications for nominal conditions. (Power source and Ambient temperature, etc)
- Sound levels can be increased in accordance with installation and operating conditions. (Operating conditions include some functional condition like Static pressure mode, air guide use, Room target temperature setting, etc and these functions are different in accordance with each model.)
- Sound level will vary depending on a range of factors such as the construction(acoustic absorption coefficient) of particular room in which the equipment is installed.
- Sound pressure level is measured on the rated condition in the anechoic rooms by ISO 3745 standard. Therefore, these values can be increased owing to ambient conditions during operation.

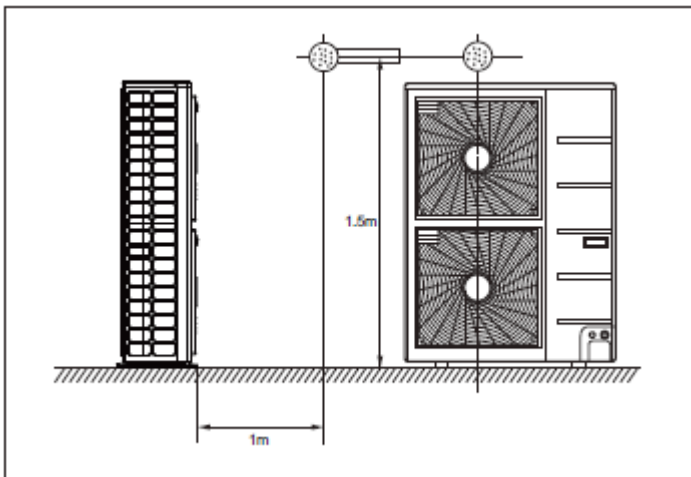

8. AVUW48GM2P1 + AVNW48GM2P1

8.1 Specifications

Category		Unit	Specification
Major	Minor		
Classification	Chassis	-	U60A
	Cooling / Heating	-	H/P
Power Supply	Case 1	-	220, 1, 60
	Case 2	-	-
	Limit Range of Voltage(Case 1)	V	198 ~ 242
	Limit Range of Voltage(Case 2)	V	-
Cooling Capacity	Rated	kW	13.78
		Btu/h	47,000
	Min ~ Max	kW	5.60~14.70
		Btu/h	19,100~50,000
	Sensible	kW	10.30
		Btu/h	35,250
Heating Capacity	Rated	kW	15.53
		Btu/h	53,000
	Min ~ Max	kW	6.10~16.50
		Btu/h	20,800~56,300
Power Input(Cooling)	Rated	kW	4.20
	Min ~ Max	kW	~-~
Power Input(Heating)	Rated	kW	4.60
	Min ~ Max	kW	~-~
Efficiency	EER	W/W	3.28
	COP	W/W	3.38
	SEER	Wh/Wh	6.39
Running Current(Cooling)	Rated	A	19.10
	Min/Max	A	- / -
Running Current(Heating)	Rated	A	20.90
	Min/Max	A	- / -
Running Current	Max	A	27.00
Power Factor(Cooling/Heating)	Rated	-	0.99 / 0.99
Outdoor Fan	Type	-	Propeller
	Air Flow Rate(Max)	m ³ /min x No.	60 x 2
	Max. External Static Pressure	Pa	-
Outdoor Fan Motor	Type	-	BLDC
	Drive	-	-
	Output	W x No.	124.2 x 2
Compressor	Type	-	Twin Rotary
	Model x No.	-	GPT442MAB x 1
	Motor Type	-	BLDC
	Motor Output	W x No.	4,000 x 1
	Oil Type	-	PVE
	Oil Charging amount	cc x No.	1,300 x 1
Heat Exchanger	Rows x Columns x FPI	-	2 x 32 x 14
	No.	-	2
	Fin Type	-	Wide Louver Plus
	Corrosion Protection (Coating)	-	-
	Material (Tube / Fin)	-	-
	Face Area	m ²	-
Dimensions	Net(W x H x D)	mm	950 x 1,380 x 330
	Shipping(W x H x D)	mm	1,140 x 1,462 x 461
Weight	Net	kg	91.3

8. AVUW48GM2P1 + AVNW48GM2P1

Category		Unit	Specification
Major	Minor		
Weight	Shipping	kg	101.3
Exterior	Color	-	Warm Gray
	RAL (Classic)	-	RAL 7044
Protection Device	High Pressure Prevention	-	-
	Frost Prevention	-	-
	Discharge Temperature Control	-	-
	Inverter Protection	-	-
Refrigerant	Type	-	R410A
	Precharged Amount	kg	3.400
	Additional Charging amount	g/m	40
	GWP(Global Warming Potential)	-	2,087.5
	t-CO ₂ eq.	-	7.098
	Chargeless-Pipe Length	m	7.5
	Control Type	-	EEV
Connecting Pipe	Liquid	mm(inch)	Φ9.52 (3/8)
	Gas	mm(inch)	Φ19.05 (3/4)
Pipe Connecting Socket	Liquid	mm(inch)	Φ9.52 (3/8)
	Gas	mm(inch)	Φ19.05 (3/4)
	Connection Type(Liquid)	-	Flare
	Connection Type(Gas)	-	Flare
Piping Length Limit	IDU - ODU(Rated / Max / Min)	m	5 / 50 / 5
Maximum Height Difference	IDU - ODU(Max)	m	30
Sound Pressure Level (Outdoor Unit)	Cooling / Heating (@ 1.5m height)	dB(A)	55.0 / 57.0
Measurement Standard (Pressure Level)	-	-	ISO 3745
Sound Power Level (Outdoor Unit)	Cooling / Heating	dB(A)	-
Measurement Standard (Power Level)	-	-	-
Connecting Cable	Power Supply Cable(H07RN-F)	mm ² × cores	6.0 x 3C
Electrical Characteristic	Minimum Circuit Amperes (MCA)	A	34.3
	Maximum Fuse Amperes (MFA)	A	40
	Comp_Rated Load Amperes (Max)	A	25.6
	Outdoor Fan Motor_Full Load Amperes (FLA)	A	1.02

Note

- Due to our policy of innovation some specifications may be changed without notification.
 - Wiring cable size must comply with the applicable local and national codes. And "Electric characteristics" should be considered for electrical work and design. Especially the power cable and circuit breaker should be selected in accordance with that.
 - Power factor could vary less than ±1% according to the operating conditions.
 - Sound level values are depend on the ambient conditions and values are normally higher in actual operation.
 - This product contains Fluorinated greenhouse gases.
 - Voltage supplied to the unit terminals should be within the minimum and maximum range.
 - Maximum allowable voltage unbalance between phase is 2%.
 - MSC means the Max. current during the starting of compressor.
 - MSC and RLA are measured as the compressor only test condition.
 - OFM and IFM are measured as the outdoor unit test condition.
 - Select the wire size based on MCA.
 - MFA is used to select the circuit breaker and ground fault circuit interrupter, and all installation site must require attachment of an earth leakage breaker. [circuit breaker type is ELCB(Earth Leakage Circuit Breaker)].
- Performances are based on the following conditions :
- Cooling : Indoor Ambient Temp. 27°CDB / 19°CWB, Outdoor Ambient Temp. 35°CDB / 24°CWB
 - Heating : Indoor Ambient Temp. 20°CDB / 15°CWB, Outdoor Ambient Temp. 7°CDB / 6°CWB
 - Interconnected Pipe Length is standard length and difference of Elevation (Outdoor ~ Indoor Unit) is 0m.

8. AVUW48GM2P1 + AVNW48GM2P1**8.2 List of Functions**

Category	Functions	Availability
Reliability	Defrost / Deicing	O
	High Pressure Switch	X
	Low Pressure Switch	X
	Phase Protection	X
	Restart Delay (3-minutes)	O
	Self Diagnosis	O
	Soft Start	O
Convenience	Night Low Noise Operation	O
	Wiring Error Check	X
	Peak Control	O
	Mode Lock	O
	Forced Cooling Operation (Outdoor Unit)	X
	Advanced SLC (Smart Load Control)	X
Special Functions	ODU Dry Contact Function	X

Note

■ O : Applied, X : Not applied

- Accessory : Ordered and purchased separately the accessory package referring to the model name provided and install at field.
- Accessory line-ups varies by region, so check your local catalogue or local sales material.

8. AVUW48GM2P1 + AVNW48GM2P1

8.3 Accessory Compatibility List

Category	Accessory Name	Model Name	Description	Compatibility
Central Controller	AC EZ	PQCSZ250S0	-	O
	AC EZ touch	PACEZA000	Touch type	O
	AC Smart IV	PACS4B000	Touch type	O
	AC Smart 5	PACS5A000	Touch type	O
	ACP IV	PACP4B000	-	O
	ACP 5	PACP5A000	-	O
	AC Manager IV	PACM4B000	For Integrated Control	O
	AC Manager 5	PACM5A000	For Integrated Control	O
Gateway	ODU PI485	PMNFP14A1	For 16-room (3 series)	O
	ACP BACnet	PQNFB17C0	-	O
	ACP Lonwork	PLNWKB000	-	O
	Cloud Gateway	PWFMDB200	-	O
Integration Device	AHU comm. kit	PAHCMR000	For AHU Control (Multi V / Single ODU Communication)	O
		PAHCMS000	For AHU Control (Multi V / Single ODU Communication)	X
	AHU Controller Module	PAHCMC000	For AHU Control (Communication Module)	X
		PAHCMM000	For AHU Control (Main Module)	X
	PDI Standard	PPWRDB000	Power distributor 2port	X
	PDI Premium	PQNUD1S40	Power distributor 8port	X

Note

- O: Possible, X: Impossible, -: Unconfirmed or irrelevant
- AC Manager requires ACP or AC Smart.
- Compatibility of individual controller(wireless/wired remote controller) could be found with function list on Indoor Unit's PDB.
- If you need more detail, please refer to the Control(BECON) PDB or the manual of product.
(<http://partner.lge.com/global> : Home> Doc.Library> Product > Control(BECON)).
- Accessory line-ups varies by region, so check your local catalogue or local sales material.

8. AVUW48GM2P1 + AVNW48GM2P1

8.4 Dimensions

8.4.1 Product

[Unit: mm]

Chassis code : U60A
DWG No. : TBA36228001_rev01

Note

- Unit should be installed in compliance with the installation manual in the product box.
- Unit should be grounded in accordance with the local regulations or applicable national codes.
- All electrical components and materials to be supplied from the site must comply with the local regulations or international codes.
- Electric characteristics chapter should be considered for electrical work and design. Especially the power cable and circuit breaker should be selected in accordance with that.

Symbols

- Piping Direction
- Datum line

No.	Part Name	Description
5	Handle	-
4	Liquid Pipe Connection	Flare joint
3	Gas Pipe Connection	Flare joint
2	Power and communication cable Hole	-
1	Air Outlet	-

8. AVUW48GM2P1 + AVNW48GM2P1

8.4.2 Install Space

For Side Discharge (capacity < 28.0 kW)

Obstacle on the Suction side

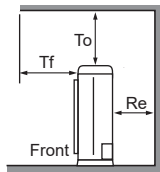

To ≥ 1,000(39-3/8)
Tf ≤ 500(19-11/16)

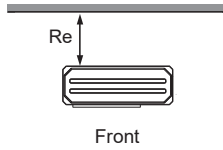

Case 1
Re ≥ 100(3-15/16)
Case 2
Re ≥ 300(11-13/16)

※ Case 1 : No obstacle on top side
Case 2 : Obstacle on top side

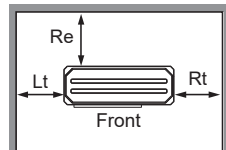

Case 1
Re ≥ 100(3-15/16)
Lt ≥ 100(3-15/16)
Rt ≥ 100(3-15/16)
Case 2
Re ≥ 300(11-13/16)
Lt ≥ 150(5-29/32)
Rt ≥ 150(5-29/32)

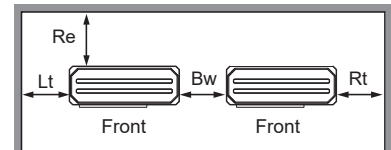

Case 1
Re ≥ 300(11-13/16)
Lt ≥ 1,000(39-3/8)
Rt ≥ 200(7-7/8)
Bw ≥ 100(3-15/16)
Case 2
Re ≥ 300(11-13/16)
Lt ≥ 1,000(39-3/8)
Rt ≥ 200(7-7/8)
Bw ≥ 100(3-15/16)

[Unit : mm(inch)]

Obstacle on the Discharge side

※ For Rear Piping / External SVC Valve type / Side-CBOX type
: Re, Lt ≥ 300(11-13/16) and Rt, Bw, Rb ≥ 600(23-5/8) for ALL CASE.

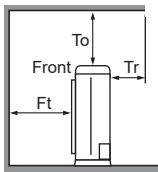
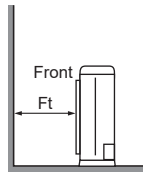

To ≥ 1,000(39-3/8)
Tr ≤ 500(19-11/16)

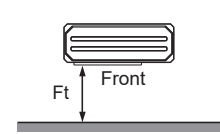

Case 1
Ft ≥ 500(19-11/16)
Case 2
Ft ≥ 500(19-11/16)

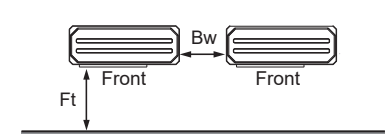

Case 1
Ft ≥ 1,000(39-3/8)
Bw ≥ 100(3-15/16)
Case 2
Ft ≥ 1,000(39-3/8)
Bw ≥ 100(3-15/16)

Obstacle on the Suction and Discharge side

Ld > H (Ls should be lower H.)

※ Close the bottom of the installation frame to prevent the discharged air from being bypassed

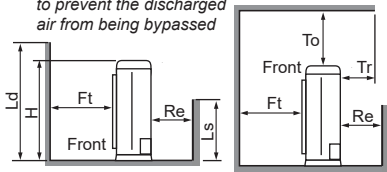

To ≥ 1,000(39-3/8)
Tf ≤ 500(19-11/16)

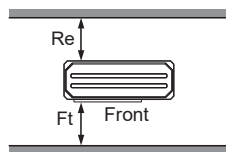

Case 1
Ft ≥ 500(19-11/16)
Re ≥ 300(11-13/16)
Case 2
Ft ≥ 1,000(39-3/8) *
Re ≥ 300(11-13/16)
* If Ls ≤ H/2,
Ft ≥ 750(29-17/32)

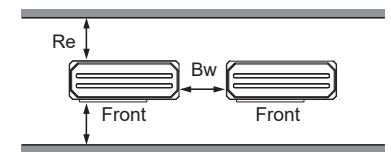

Case 1
Ft ≥ 1,000(39-3/8)
Re ≥ 300(11-13/16)
Bw ≥ 100(3-15/16)
Case 2
Ft ≥ 1,250(49-7/32)
Re ≥ 300(11-13/16)
Bw ≥ 100(3-15/16)

Ld ≤ H

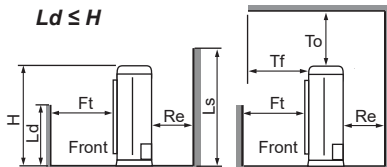

To ≥ 1,000(39-3/8)
Tf ≤ 500(19-11/16)

Case 1
Ft ≥ 500(19-11/16)
Re ≥ 300(11-13/16)
Case 2
Ft ≥ 1,000(39-3/8)
Re ≥ 300(11-13/16)

Case 1
Ft ≥ 1,500(59-1/16)
Re ≥ 300(11-13/16)
Bw ≥ 100(3-15/16)
Case 2
Ft ≥ 1,500(59-1/16)
Re ≥ 300(11-13/16)
Bw ≥ 100(3-15/16)

※ In case of series installation (2 Units or more) for 2 Fan models, Ld should be lower than H/2.

Collective/Continuous Installation (Multiple Columns)

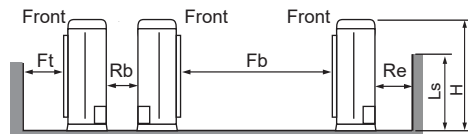

※ In case of Multiple columns/continuous installation, Ls should be lower than H.

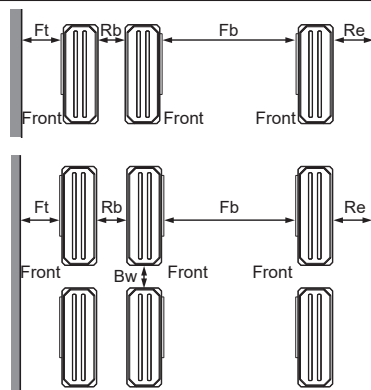

1 Column

Ft ≥ 1,000(39-3/8)
Rb ≥ 200(7-7/8)
Fb ≥ 2,000(78-3/4)
Re ≥ 100(3-15/16)

Multiple Columns

Ft ≥ 1,500(59-1/16)
Rb ≥ 600(23-5/8)
Fb ≥ 3,000(118-1/8)
Re ≥ 300(11-13/16)
Bw ≥ 100(3-15/16)

Note

- If there is a concern about product performance degradation due to group installation or interference with obstacles, secure an additional separation distance.
- Secure enough space for smooth service and maintenance.
- According to product type, model line up, sales region..etc, applicability of each chassis could be different.

8. AVUW48GM2P1 + AVNW48GM2P1

8.5 Piping Diagrams

8.5.1 Normal

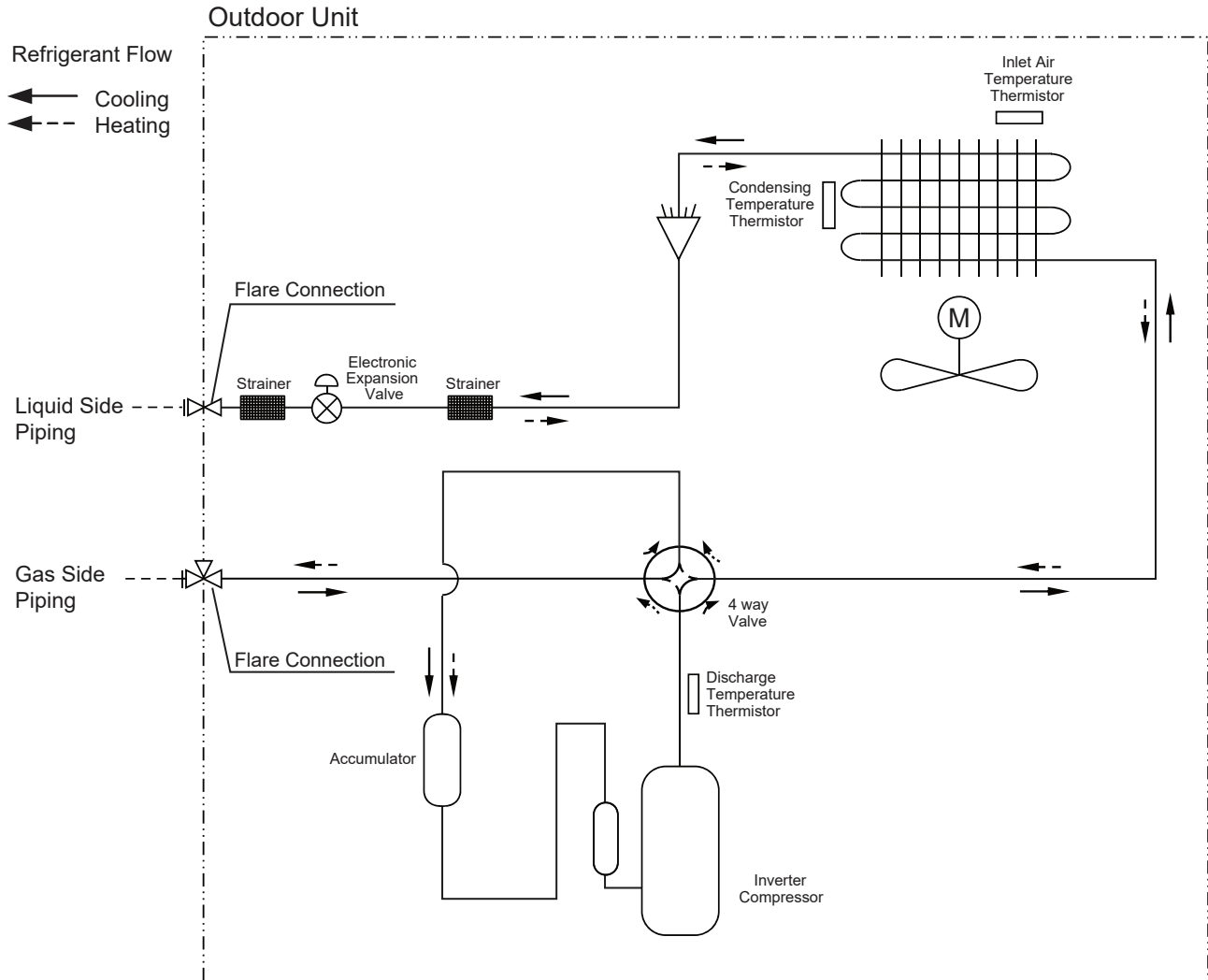

8. AVUW48GM2P1 + AVNW48GM2P1

8.6 Wiring Diagrams

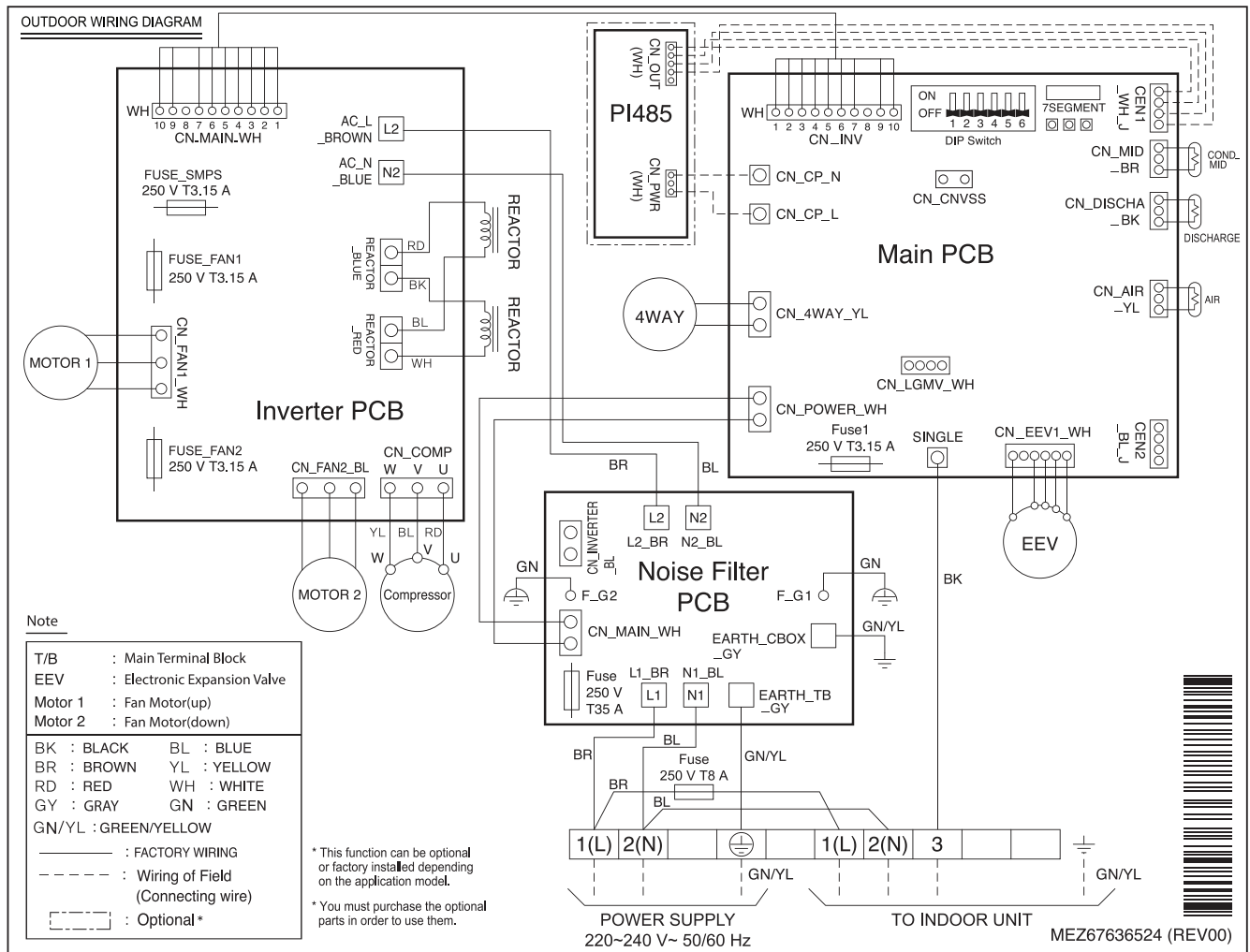

8. AVUW48GM2P1 + AVNW48GM2P1

8.7 Capacity Tables

8.7.1 Cooling

Outdoor Air Temp. (°C, DB)	Indoor Air Temp. (°C, DB/WB)																				
	20.0 / 14.0			22.0 / 16.0			25.0 / 18.0			27.0 / 19.0			28.0 / 20.0			30.0 / 22.0			32.0 / 24.0		
	TC	SHC	PI	TC	SHC	PI	TC	SHC	PI	TC	SHC	PI	TC	SHC	PI	TC	SHC	PI	TC	SHC	PI
20	8.09	6.94	1.71	10.52	8.29	2.15	12.37	9.63	2.49	13.78	10.30	2.73	14.25	10.24	2.76	15.19	10.11	2.81	16.26	9.98	2.83
25	8.09	6.94	2.02	10.52	8.29	2.53	12.37	9.63	2.93	13.78	10.30	3.22	14.25	10.24	3.25	15.19	10.11	3.32	16.26	9.98	3.33
32	8.09	6.94	2.45	10.52	8.29	3.07	12.37	9.63	3.56	13.78	10.30	3.91	14.25	10.24	3.95	15.19	10.11	4.02	16.26	9.98	4.05
35	8.09	6.94	2.63	10.52	8.29	3.30	12.37	9.63	3.83	13.78	10.30	4.20	14.25	10.24	4.24	15.19	10.11	4.33	16.26	9.98	4.35
40	8.09	6.94	2.83	10.52	8.29	3.55	12.37	9.63	4.12	13.78	10.30	4.52	14.25	10.24	4.56	15.19	10.11	4.65	16.26	9.98	4.68
43	8.09	6.94	2.95	10.52	8.29	3.70	12.37	9.63	4.29	13.78	10.30	4.70	14.25	10.24	4.75	15.19	10.11	4.85	16.26	9.98	4.87
46	8.09	6.94	3.07	10.52	8.29	3.86	11.22	8.79	4.40	11.45	8.65	4.49	11.84	8.59	4.54	12.62	8.46	4.63	13.50	8.34	4.65
48	8.09	6.94	3.20	10.52	8.29	4.02	10.78	8.44	4.28	11.00	8.37	4.37	11.31	8.26	4.41	11.92	8.04	4.50	12.64	7.84	4.52
50	8.09	6.94	3.33	10.13	8.06	4.07	10.34	8.19	4.16	10.55	8.09	4.24	10.78	7.93	4.28	11.23	7.62	4.37	11.77	7.34	4.39
52	8.09	6.94	3.47	9.70	7.80	3.95	9.89	7.92	4.03	10.10	7.80	4.12	10.24	7.60	4.16	10.53	7.19	4.24	10.90	6.83	4.26
54	8.09	6.94	3.62	9.26	7.54	3.83	9.45	7.66	3.91	9.65	7.51	3.99	9.71	7.26	4.03	9.84	6.75	4.11	10.04	6.31	4.13

Note

- DB : Dry bulb temperature(°C), WB : Wet bulb temperature(°C)
- TC : Total Capacity(kW), SHC : Sensible Heat Capacity(kW)
- PI : Power Input (kW, Compressor + indoor fan motor + outdoor fan motor)
- All capacities are net. A deduction of capacity due to operating heat of indoor unit motor is reflected.
- Direct interpolation is permissible. Do not extrapolate.
- Rated capacities and power inputs are based on standard temperature and piping conditions, and it can be found on specifications table.
Except for rated value, the performance is not guaranteed.
- In accordance with the test standard(or nations), the rating will vary slightly.

8. AVUW48GM2P1 + AVNW48GM2P1

8.7.2 Heating

Outdoor Air Temp. (°C, WB)	Indoor Air Temp. (°C, DB)									
	16.0		18.0		20.0		22.0		24.0	
	TC	PI	TC	PI	TC	PI	TC	PI	TC	PI
-5.0	14.13	3.99	14.06	4.37	13.98	4.75	13.91	5.14	13.84	5.52
0.0	15.69	4.75	15.61	5.14	15.53	5.52	14.91	5.21	14.29	4.89
6.0	17.19	5.06	16.36	4.83	15.53	4.60	14.91	4.37	14.29	4.14
10.0	17.19	4.75	16.36	4.37	15.53	3.99	14.91	3.81	14.29	3.64
15.0	17.19	3.99	16.36	3.60	15.53	3.22	14.91	3.12	14.29	3.01
18.0	17.19	3.53	16.36	3.14	15.53	2.76	14.91	2.70	14.29	2.64

Note

- DB : Dry bulb temperature(°C), WB : Wet bulb temperature(°C)
- TC : Total Capacity(kW)
- PI : Power Input (kW, Compressor + indoor fan motor + outdoor fan motor)
- All capacities are net. An addition of capacity due to operating heat of indoor unit motor is reflected.
- Direct interpolation is permissible. Do not extrapolate.
- Rated capacities and power inputs are based on standard temperature and piping conditions, and it can be found on specifications table.
Except for rated value, the performance is not guaranteed.
- In accordance with the test standard(or nations), the rating will vary slightly.

8. AVUW48GM2P1 + AVNW48GM2P1

8.8 Capacity Correction Factor

Operation	Capacity correction factor (%) by Equivalent pipe length (m)										
	5	7.5	10	15	20	25	30	35	40	45	50
Cooling	100.0	99.6	99.3	97.9	96.6	95.2	93.8	92.4	91.1	89.8	88.4
Heating	100.0	99.9	99.7	99.2	98.7	98.2	97.7	97.1	96.6	96.1	95.6

Note

In Order to estimate the actual system capacity, the influence of various installation conditions should be reflected.

Reflect the capacity correction factor effect of piping installation as below.

- Qodu [from specification table] : Outdoor unit standard capacity.
- Q(Ti, To) [from capacity table] : Outdoor unit capacity at Ti, To temperature.
- F(Ti, To) = Q(Ti, To) / Qodu. : Outdoor unit capacity correction factor
- Fpiping for piping length [from capacity correction factor table] : Piping correction factor
- Indoor unit actual capacity : Qactual = Qodu x F(Ti, To) x Fpiping

8. AVUW48GM2P1 + AVNW48GM2P1

8.9 Operation Limits

8.9.1 Cooling

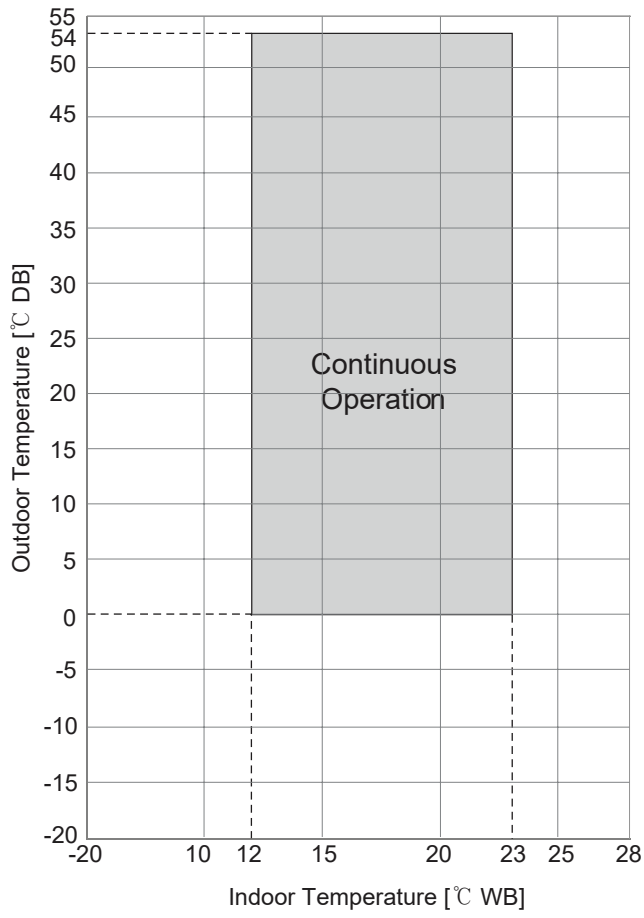

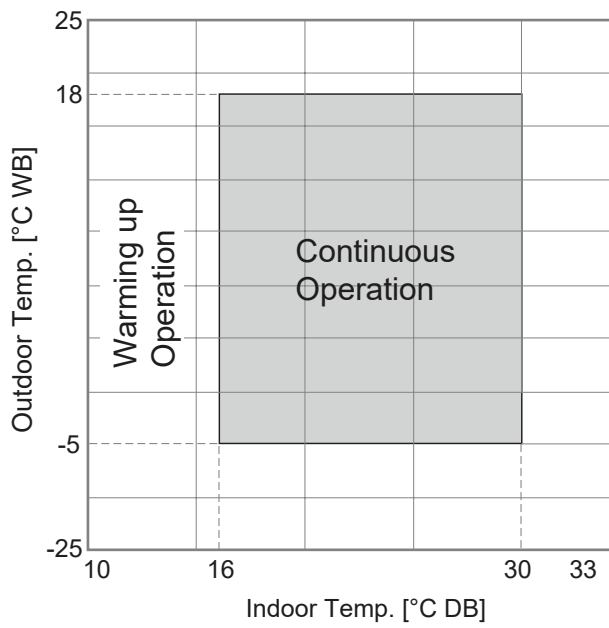
8. AVUW48GM2P1 + AVNW48GM2P1**8.9.2 Heating****Note**

- Warming up operation and operative mean that the outdoor unit operates to reach the range of continuous operating, however it may not operate continuously due to safety or protection logic.

8. AVUW48GM2P1 + AVNW48GM2P1

8.10 Sound Levels

8.10.1 Pressure Levels

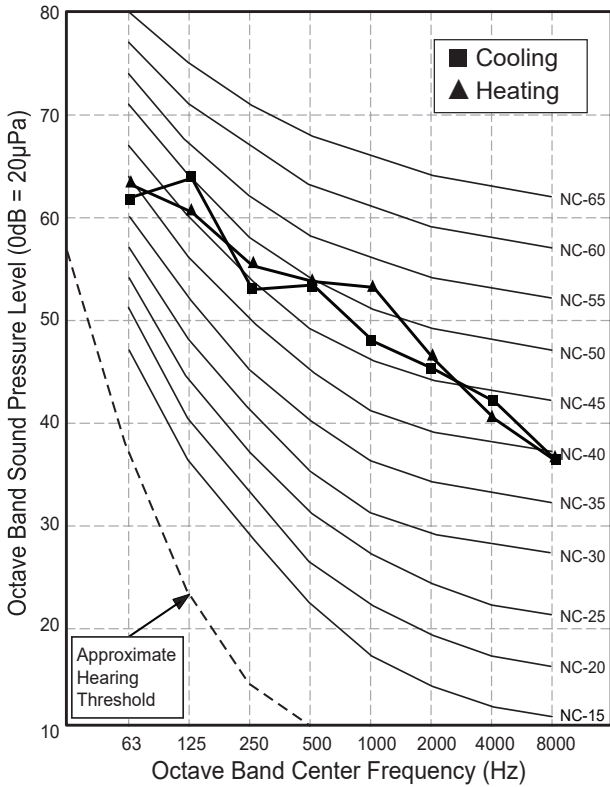

Sound level [dB(A), @ Standard condition]	
Cooling / Heating (@ 1.5m height)	55.0 / 57.0

Note

- Data is valid at diffuse field condition.
- Data is valid at nominal operating condition.
- Reference acoustic pressure 0dB = 20µPa.
- Refer to the model specifications for nominal conditions. (Power source and Ambient temperature, etc)
- Sound levels can be increased in accordance with installation and operating conditions. (Operating conditions include some functional condition like Static pressure mode, air guide use, Room target temperature setting, etc and these functions are different in accordance with each model.)
- Sound level will vary depending on a range of factors such as the construction(acoustic absorption coefficient) of particular room in which the equipment is installed.
- Sound pressure level is measured on the rated condition in the anechoic rooms by ISO 3745 standard. Therefore, these values can be increased owing to ambient conditions during operation.

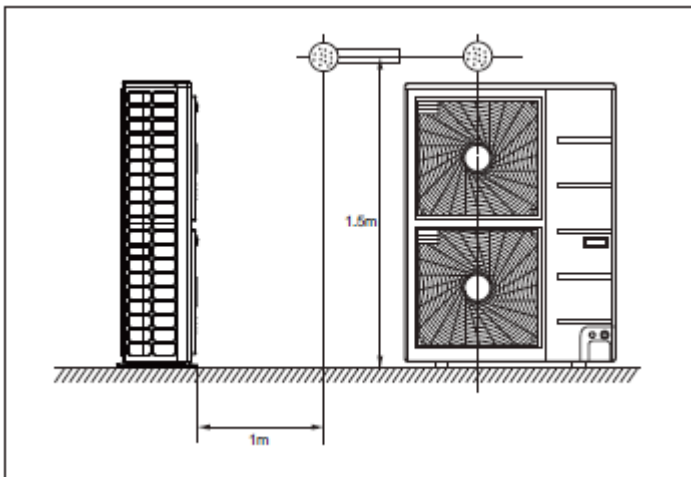

9. ATUW60GMLP1 + ATNW60GMLP1

9.1 Specifications

Category		Unit	Specification
Major	Minor		
Classification	Chassis	-	U60A
	Cooling / Heating	-	H/P
Power Supply	Case 1	-	220, 1, 60
	Case 2	-	-
	Limit Range of Voltage(Case 1)	V	198~242
	Limit Range of Voltage(Case 2)	V	-
Cooling Capacity	Rated	kW	14.65
		Btu/h	50,000
	Min ~ Max	kW	6.00~15.80
		Btu/h	20,500~54,000
	Sensible	kW	10.99
		Btu/h	37,500
Heating Capacity	Rated	kW	17.00
		Btu/h	58,000
	Min ~ Max	kW	6.80~18.20
		Btu/h	23,200~62,100
Power Input(Cooling)	Rated	kW	4.75
	Min ~ Max	kW	~
Power Input(Heating)	Rated	kW	5.25
	Min ~ Max	kW	~
Efficiency	EER	W/W	3.08
	COP	W/W	3.24
	SEER	Wh/Wh	6.16
Running Current(Cooling)	Rated	A	21.60
	Min/Max	A	- / -
Running Current(Heating)	Rated	A	23.90
	Min/Max	A	- / -
Running Current	Max	A	27.00
Power Factor(Cooling/Heating)	Rated	-	0.99 / 0.99
Outdoor Fan	Type	-	Propeller
	Air Flow Rate(Max)	m ³ /min x No.	60 x 2
	Max. External Static Pressure	Pa	-
Outdoor Fan Motor	Type	-	BLDC
	Drive	-	-
	Output	W x No.	124.2 x 2
Compressor	Type	-	Twin Rotary
	Model x No.	-	GPT442MAB x 1
	Motor Type	-	BLDC
	Motor Output	W x No.	4,000 x 1
	Oil Type	-	PVE
	Oil Charging amount	cc x No.	1,300 x 1
Heat Exchanger	Rows x Columns x FPI	-	2 x 32 x 14
	No.	-	2
	Fin Type	-	Wide Louver Plus
	Corrosion Protection (Coating)	-	-
	Material (Tube / Fin)	-	-
	Face Area	m ²	-
Dimensions	Net(W x H x D)	mm	950 x 1,380 x 330
	Shipping(W x H x D)	mm	1,140 x 1,462 x 461
Weight	Net	kg	91.3

9. ATUW60GMLP1 + ATNW60GMLP1

Category		Unit	Specification
Major	Minor		
Weight	Shipping	kg	101.3
Exterior	Color	-	Warm Gray
	RAL (Classic)	-	RAL 7044
Protection Device	High Pressure Prevention	-	-
	Frost Prevention	-	-
	Discharge Temperature Control	-	-
	Inverter Protection	-	-
Refrigerant	Type	-	R410A
	Precharged Amount	kg	3.400
	Additional Charging amount	g/m	40
	GWP(Global Warming Potential)	-	2,087.5
	t-CO ₂ eq.	-	7.098
	Chargeless-Pipe Length	m	7.5
	Control Type	-	EEV
Connecting Pipe	Liquid	mm(inch)	Φ9.52 (3/8)
	Gas	mm(inch)	Φ19.05 (3/4)
Pipe Connecting Socket	Liquid	mm(inch)	Φ9.52 (3/8)
	Gas	mm(inch)	Φ19.05 (3/4)
	Connection Type(Liquid)	-	Flare
	Connection Type(Gas)	-	Flare
Piping Length Limit	IDU - ODU(Rated / Max / Min)	m	5 / 50 /5
Maximum Height Difference	IDU - ODU(Max)	m	30
Sound Pressure Level (Outdoor Unit)	Cooling / Heating (@ 1.5m height)	dB(A)	55.0 / 57.0
Measurement Standard (Pressure Level)	-	-	ISO 3745
Sound Power Level (Outdoor Unit)	Cooling / Heating	dB(A)	-
Measurement Standard (Power Level)	-	-	-
Connecting Cable	Power Supply Cable(H07RN-F)	mm ² × cores	6.0 × 3C
Electrical Characteristic	Minimum Circuit Amperes (MCA)	A	34.3
	Maximum Fuse Amperes (MFA)	A	40
	Comp_Rated Load Amperes (Max)	A	25.6
	Outdoor Fan Motor_Full Load Amperes (FLA)	A	1.02

Note

- Due to our policy of innovation some specifications may be changed without notification.
 - Wiring cable size must comply with the applicable local and national codes. And "Electric characteristics" should be considered for electrical work and design. Especially the power cable and circuit breaker should be selected in accordance with that.
 - Power factor could vary less than ±1% according to the operating conditions.
 - Sound level values are depend on the ambient conditions and values are normally higher in actual operation.
 - This product contains Fluorinated greenhouse gases.
 - Voltage supplied to the unit terminals should be within the minimum and maximum range.
 - Maximum allowable voltage unbalance between phase is 2%.
 - MSC means the Max. current during the starting of compressor.
 - MSC and RLA are measured as the compressor only test condition.
 - OFM and IFM are measured as the outdoor unit test condition.
 - Select the wire size based on MCA.
 - MFA is used to select the circuit breaker and ground fault circuit interrupter, and all installation site must require attachment of an earth leakage breaker. [circuit breaker type is ELCB(Earth Leakage Circuit Breaker)].
- Performances are based on the following conditions :
- Cooling : Indoor Ambient Temp. 27°CDB / 19°CWB, Outdoor Ambient Temp. 35°CDB / 24°CWB
 - Heating : Indoor Ambient Temp. 20°CDB / 15°CWB, Outdoor Ambient Temp. 7°CDB / 6°CWB
 - Interconnected Pipe Length is standard length and difference of Elevation (Outdoor ~ Indoor Unit) is 0m.

9. ATUW60GMLP1 + ATNW60GMLP1**9.2 List of Functions**

Category	Functions	Availability
Reliability	Defrost / Deicing	O
	High Pressure Switch	X
	Low Pressure Switch	X
	Phase Protection	X
	Restart Delay (3-minutes)	O
	Self Diagnosis	O
	Soft Start	O
Convenience	Night Low Noise Operation	O
	Wiring Error Check	X
	Peak Control	O
	Mode Lock	O
	Forced Cooling Operation (Outdoor Unit)	X
	Advanced SLC (Smart Load Control)	X
Special Functions	ODU Dry Contact Function	X

Note

- O : Applied, X : Not applied
- Accessory : Ordered and purchased separately the accessory package referring to the model name provided and install at field.
- Accessory line-ups varies by region, so check your local catalogue or local sales material.

9. ATUW60GMLP1 + ATNW60GMLP1

9.3 Accessory Compatibility List

Category	Accessory Name	Model Name	Description	Compatibility
Central Controller	AC EZ	PQCSZ250S0	-	O
	AC EZ touch	PACEZA000	Touch type	O
	AC Smart IV	PACS4B000	Touch type	O
	AC Smart 5	PACS5A000	Touch type	O
	ACP IV	PACP4B000	-	O
	ACP 5	PACP5A000	-	O
	AC Manager IV	PACM4B000	For Integrated Control	O
	AC Manager 5	PACM5A000	For Integrated Control	O
Gateway	ODU PI485	PMNFP14A1	For 16-room (3 series)	O
	ACP BACnet	PQNFB17C0	-	O
	ACP Lonwork	PLNWKB000	-	O
	Cloud Gateway	PWFMDB200	-	O
Integration Device	AHU comm. kit	PAHCMR000	For AHU Control (Multi V / Single ODU Communication)	O
		PAHCMS000	For AHU Control (Multi V / Single ODU Communication)	X
	AHU Controller Module	PAHCMC000	For AHU Control (Communication Module)	X
		PAHCMM000	For AHU Control (Main Module)	X
	PDI Standard	PPWRDB000	Power distributor 2port	X
	PDI Premium	PQNUD1S40	Power distributor 8port	X

Note

- O: Possible, X: Impossible, -: Unconfirmed or irrelevant
- AC Manager requires ACP or AC Smart.
- Compatibility of individual controller(wireless/wired remote controller) could be found with function list on Indoor Unit's PDB.
- If you need more detail, please refer to the Control(BECON) PDB or the manual of product.
(<http://partner.lge.com/global> : Home> Doc.Library> Product > Control(BECON)).
- Accessory line-ups varies by region, so check your local catalogue or local sales material.

9. ATUW60GMLP1 + ATNW60GMLP1

9.4 Dimensions

9.4.1 Product

[Unit: mm]
Chassis code : U60A
DWG No. : TBA36228001_rev01

Gravity point

3D View

Front View
Dimensions: 1980 (total width), 1254 (fan width), 950 (total height), 550 (fan height), 90 (top panel height), 390 (width to fan center), 360 (width to fan edge), 165 (width to top edge), 40 (bottom offset), 291 (fan offset), 276 (fan offset), 111 (fan offset), 91 (fan offset), 250 (fan offset), 696 (total depth), 416 (depth to fan center), 72 (depth to top edge), 51 (depth to fan edge), 541 (depth to fan center), 606 (depth to fan edge), 137 (depth to top edge), 83 (depth to fan edge), 148 (depth to fan center), 69 (depth to fan edge).

Top View
Dimensions: 620 (width), 4 holes for Anchor Bolts (M10), Piping Direction arrow.

Side View
Dimensions: 330 (width), 33 (height to top), 25 (height to bottom), 5-D. \varnothing 20 holes for drain connection.

Internal View
Dimensions: 416 (total depth), 291 (fan offset), 276 (fan offset), 111 (fan offset), 91 (fan offset), 250 (fan offset), 696 (total depth).

Note

- Unit should be installed in compliance with the installation manual in the product box.
- Unit should be grounded in accordance with the local regulations or applicable national codes.
- All electrical components and materials to be supplied from the site must comply with the local regulations or international codes.
- Electric characteristics chapter should be considered for electrical work and design. Especially the power cable and circuit breaker should be selected in accordance with that.

Symbols

- Piping Direction
- Datum line

No.	Part Name	Description
5	Handle	-
4	Liquid Pipe Connection	Flare joint
3	Gas Pipe Connection	Flare joint
2	Power and communication cable Hole	-
1	Air Outlet	-

9. ATUW60GMLP1 + ATNW60GMLP1

9.4.2 Install Space

For Side Discharge (capacity < 28.0 kW)

Obstacle on the Suction side

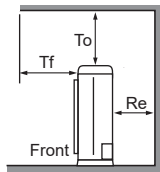

To ≥ 1,000(39-3/8)
Tf ≤ 500(19-11/16)

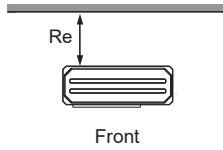

Case 1
Re ≥ 100(3-15/16)
Case 2
Re ≥ 300(11-13/16)

※ Case 1 : No obstacle on top side
Case 2 : Obstacle on top side

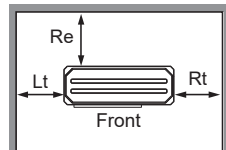

Case 1
Re ≥ 100(3-15/16)
Lt ≥ 100(3-15/16)
Rt ≥ 100(3-15/16)
Case 2
Re ≥ 300(11-13/16)
Lt ≥ 150(5-29/32)
Rt ≥ 150(5-29/32)

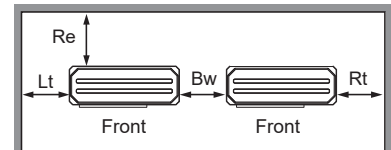

Case 1
Re ≥ 300(11-13/16)
Lt ≥ 1,000(39-3/8)
Rt ≥ 200(7-7/8)
Bw ≥ 100(3-15/16)
Case 2
Re ≥ 300(11-13/16)
Lt ≥ 1,000(39-3/8)
Rt ≥ 200(7-7/8)
Bw ≥ 100(3-15/16)

[Unit : mm(inch)]

Obstacle on the Discharge side

※ For Rear Piping / External SVC Valve type / Side-CBOX type
: Re, Lt ≥ 300(11-13/16) and Rt, Bw, Rb ≥ 600(23-5/8) for ALL CASE.

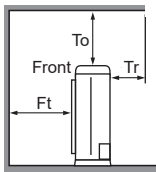
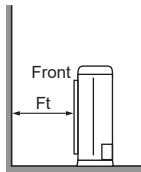

To ≥ 1,000(39-3/8)
Tr ≤ 500(19-11/16)

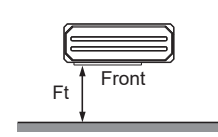

Case 1
Ft ≥ 500(19-11/16)
Case 2
Ft ≥ 500(19-11/16)

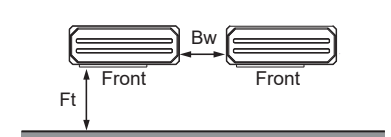

Case 1
Ft ≥ 1,000(39-3/8)
Bw ≥ 100(3-15/16)
Case 2
Ft ≥ 1,000(39-3/8)
Bw ≥ 100(3-15/16)

Obstacle on the Suction and Discharge side

Ld > H (Ls should be lower H.)

※ Close the bottom of the installation frame to prevent the discharged air from being bypassed

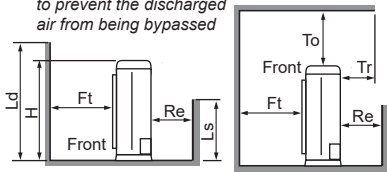

To ≥ 1,000(39-3/8)
Tf ≤ 500(19-11/16)

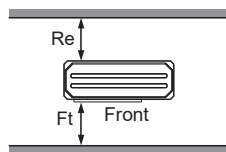

Case 1
Ft ≥ 500(19-11/16)
Re ≥ 300(11-13/16)
Case 2
Ft ≥ 1,000(39-3/8) *
Re ≥ 300(11-13/16)
* If Ls ≤ H/2,
Ft ≥ 750(29-17/32)

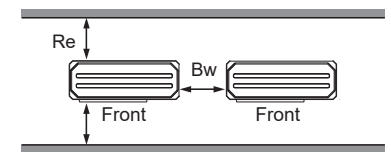

Case 1
Ft ≥ 1,000(39-3/8)
Re ≥ 300(11-13/16)
Bw ≥ 100(3-15/16)
Case 2
Ft ≥ 1,250(49-7/32)
Re ≥ 300(11-13/16)
Bw ≥ 100(3-15/16)

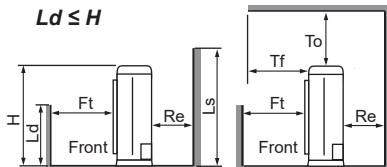

To ≥ 1,000(39-3/8)
Tf ≤ 500(19-11/16)

Case 1
Ft ≥ 500(19-11/16)
Re ≥ 300(11-13/16)
Case 2
Ft ≥ 1,000(39-3/8)
Re ≥ 300(11-13/16)

Case 1
Ft ≥ 1,500(59-1/16)
Re ≥ 300(11-13/16)
Bw ≥ 100(3-15/16)
Case 2
Ft ≥ 1,500(59-1/16)
Re ≥ 300(11-13/16)
Bw ≥ 100(3-15/16)

※ In case of series installation (2 Units or more) for 2 Fan models, Ld should be lower than H/2.

Collective/Continuous Installation (Multiple Columns)

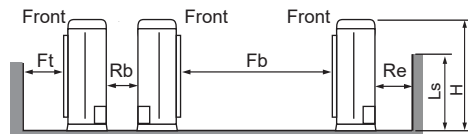

※ In case of Multiple columns/continuous installation, Ls should be lower than H.

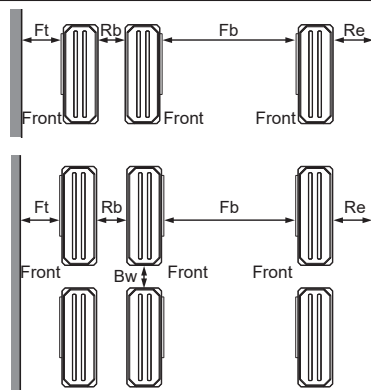

1 Column

Ft ≥ 1,000(39-3/8)
Rb ≥ 200(7-7/8)
Fb ≥ 2,000(78-3/4)
Re ≥ 100(3-15/16)

Multiple Columns

Ft ≥ 1,500(59-1/16)
Rb ≥ 600(23-5/8)
Fb ≥ 3,000(118-1/8)
Re ≥ 300(11-13/16)
Bw ≥ 100(3-15/16)

Note

- If there is a concern about product performance degradation due to group installation or interference with obstacles, secure an additional separation distance.
- Secure enough space for smooth service and maintenance.
- According to product type, model line up, sales region..etc, applicability of each chassis could be different.

9. ATUW60GMLP1 + ATNW60GMLP1

9.5 Piping Diagrams

9.5.1 Normal

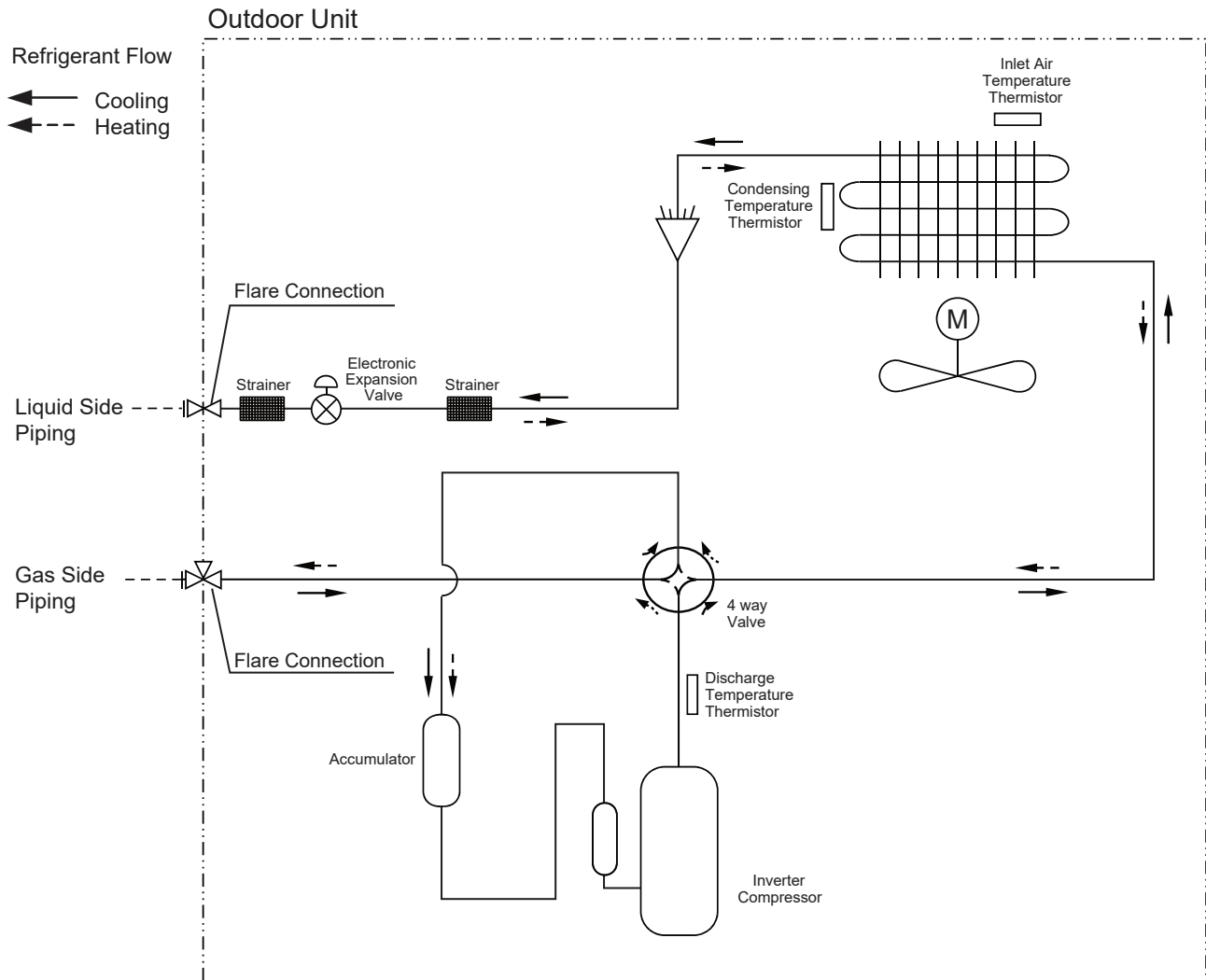

9. ATUW60GMLP1 + ATNW60GMLP1

9.6 Wiring Diagrams

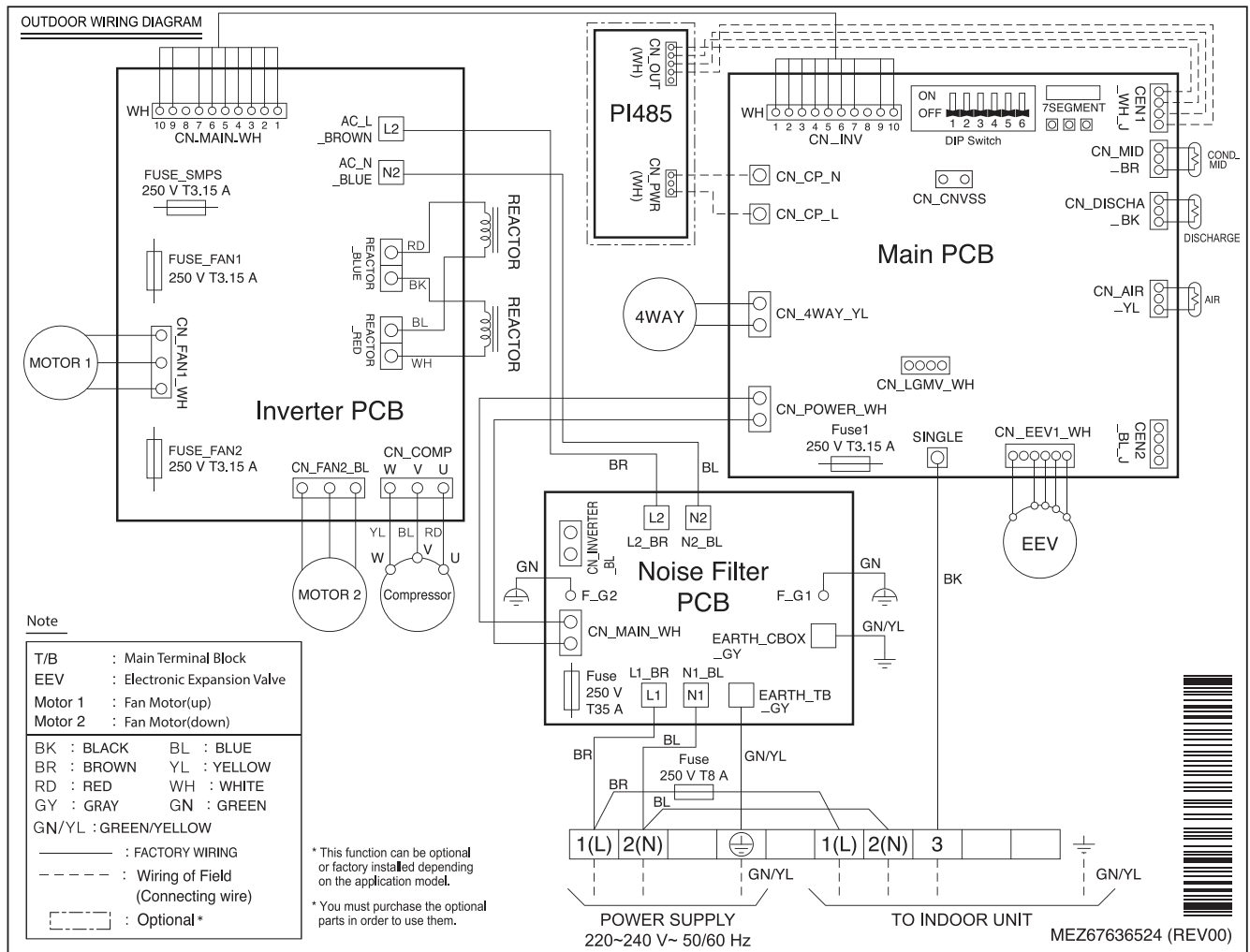

9. ATUW60GMLP1 + ATNW60GMLP1

9.7 Capacity Tables

9.7.1 Cooling

Outdoor Air Temp. (°C, DB)	Indoor Air Temp. (°C, DB/WB)																				
	20.0 / 14.0			22.0 / 16.0			25.0 / 18.0			27.0 / 19.0			28.0 / 20.0			30.0 / 22.0			32.0 / 24.0		
	TC	SHC	PI	TC	SHC	PI	TC	SHC	PI	TC	SHC	PI	TC	SHC	PI	TC	SHC	PI	TC	SHC	PI
20	8.60	7.41	1.93	11.19	8.84	2.43	13.15	10.27	2.81	14.65	10.99	3.09	15.15	10.92	3.12	16.15	10.78	3.18	17.28	10.65	3.20
25	8.60	7.41	2.28	11.19	8.84	2.86	13.15	10.27	3.32	14.65	10.99	3.64	15.15	10.92	3.68	16.15	10.78	3.75	17.28	10.65	3.77
32	8.60	7.41	2.77	11.19	8.84	3.48	13.15	10.27	4.03	14.65	10.99	4.42	15.15	10.92	4.46	16.15	10.78	4.55	17.28	10.65	4.58
35	8.60	7.41	2.98	11.19	8.84	3.74	13.15	10.27	4.33	14.65	10.99	4.75	15.15	10.92	4.80	16.15	10.78	4.89	17.28	10.65	4.92
40	8.60	7.41	3.20	11.19	8.84	4.02	13.15	10.27	4.66	14.65	10.99	5.11	15.15	10.92	5.16	16.15	10.78	5.26	17.28	10.65	5.29
43	8.60	7.41	3.33	11.19	8.84	4.19	13.15	10.27	4.85	14.65	10.99	5.32	15.15	10.92	5.37	16.15	10.78	5.48	17.28	10.65	5.51
46	8.60	7.41	3.47	11.19	8.84	4.36	11.93	9.38	4.98	12.17	9.23	5.08	12.59	9.17	5.13	13.42	9.04	5.23	14.36	8.90	5.26
48	8.60	7.41	3.62	11.19	8.84	4.54	11.46	9.01	4.84	11.69	8.94	4.94	12.02	8.82	4.99	12.68	8.59	5.09	13.44	8.37	5.11
50	8.60	7.41	3.77	10.77	8.61	4.61	10.99	8.74	4.70	11.21	8.63	4.80	11.45	8.46	4.85	11.94	8.13	4.94	12.52	7.83	4.97
52	8.60	7.41	3.93	10.31	8.33	4.47	10.52	8.46	4.56	10.73	8.33	4.65	10.89	8.11	4.70	11.20	7.67	4.79	11.59	7.28	4.82
54	8.60	7.41	4.09	9.85	8.04	4.33	10.05	8.17	4.42	10.26	8.02	4.51	10.33	7.75	4.56	10.46	7.21	4.65	10.67	6.73	4.68

Note

- DB : Dry bulb temperature(°C), WB : Wet bulb temperature(°C)
- TC : Total Capacity(kW), SHC : Sensible Heat Capacity(kW)
- PI : Power Input (kW, Compressor + indoor fan motor + outdoor fan motor)
- All capacities are net. A deduction of capacity due to operating heat of indoor unit motor is reflected.
- Direct interpolation is permissible. Do not extrapolate.
- Rated capacities and power inputs are based on standard temperature and piping conditions, and it can be found on specifications table.
Except for rated value, the performance is not guaranteed.
- In accordance with the test standard(or nations), the rating will vary slightly.

9. ATUW60GMLP1 + ATNW60GMLP1

9.7.2 Heating

Outdoor Air Temp. (°C, WB)	Indoor Air Temp. (°C, DB)									
	16.0		18.0		20.0		22.0		24.0	
	TC	PI	TC	PI	TC	PI	TC	PI	TC	PI
-5.0	15.47	4.55	15.39	4.99	15.30	5.43	15.22	5.86	15.15	6.30
0.0	17.17	5.43	17.09	5.86	17.00	6.30	16.32	5.94	15.64	5.58
6.0	18.82	5.78	17.91	5.51	17.00	5.25	16.32	4.99	15.64	4.73
10.0	18.82	5.43	17.91	4.99	17.00	4.55	16.32	4.35	15.64	4.15
15.0	18.82	4.55	17.91	4.11	17.00	3.68	16.32	3.56	15.64	3.44
18.0	18.82	4.03	17.91	3.59	17.00	3.15	16.32	3.08	15.64	3.01

Note

- DB : Dry bulb temperature(°C), WB : Wet bulb temperature(°C)
- TC : Total Capacity(kW)
- PI : Power Input (kW, Compressor + indoor fan motor + outdoor fan motor)
- All capacities are net. An addition of capacity due to operating heat of indoor unit motor is reflected.
- Direct interpolation is permissible. Do not extrapolate.
- Rated capacities and power inputs are based on standard temperature and piping conditions, and it can be found on specifications table.
Except for rated value, the performance is not guaranteed.
- In accordance with the test standard(or nations), the rating will vary slightly.

9. ATUW60GMLP1 + ATNW60GMLP1

9.8 Capacity Correction Factor

Operation	Capacity correction factor (%) by Equivalent pipe length (m)										
	5	7.5	10	15	20	25	30	35	40	45	50
Cooling	100.0	99.6	99.3	97.9	96.6	95.2	93.8	92.4	91.1	89.8	88.4
Heating	100.0	99.9	99.7	99.2	98.7	98.2	97.7	97.1	96.6	96.1	95.6

Note

In Order to estimate the actual system capacity, the influence of various installation conditions should be reflected.

Reflect the capacity correction factor effect of piping installation as below.

- Qodu [from specification table] : Outdoor unit standard capacity.
- Q(Ti, To) [from capacity table] : Outdoor unit capacity at Ti, To temperature.
- F(Ti, To) = Q(Ti, To) / Qodu. : Outdoor unit capacity correction factor
- Fpiping for piping length [from capacity correction factor table] : Piping correction factor
- Indoor unit actual capacity : Qactual = Qodu x F(Ti, To) x Fpiping

9. ATUW60GMLP1 + ATNW60GMLP1

9.9 Operation Limits

9.9.1 Cooling

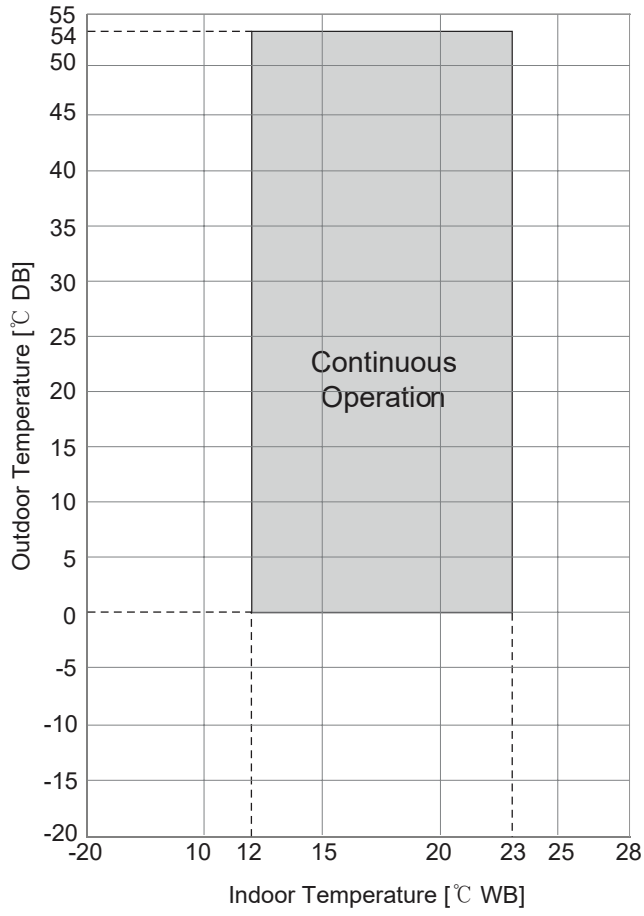

9. ATUW60GMLP1 + ATNW60GMLP1

9.9.2 Heating

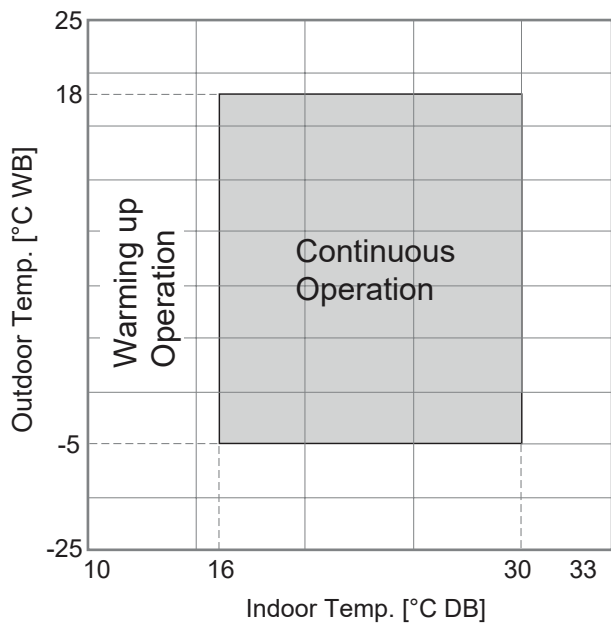

Note

- Warming up operation and operative mean that the outdoor unit operates to reach the range of continuous operating, however it may not operate continuously due to safety or protection logic.

9. ATUW60GMLP1 + ATNW60GMLP1

9.10 Sound Levels

9.10.1 Pressure Levels

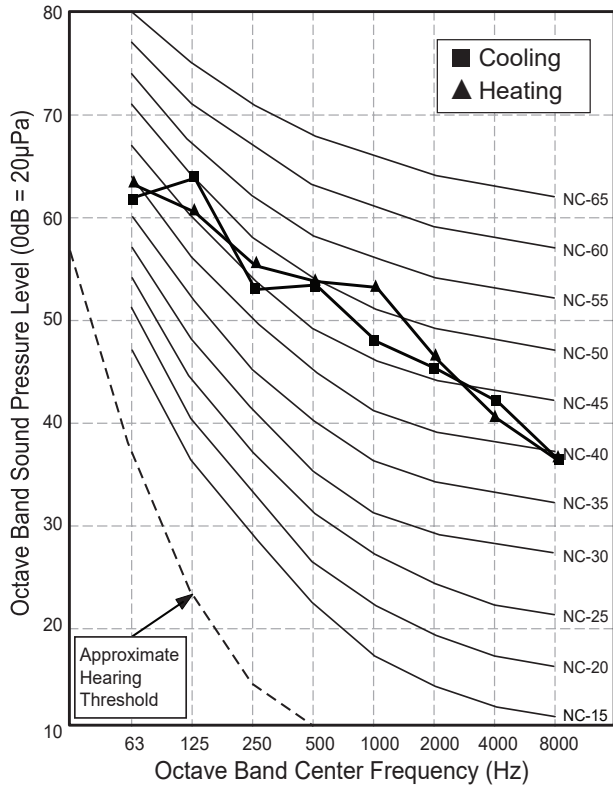

Sound level [dB(A), @ Standard condition]	
Cooling / Heating (@ 1.5m height)	55.0 / 57.0

Note

- Data is valid at diffuse field condition.
- Data is valid at nominal operating condition.
- Reference acoustic pressure 0dB = 20µPa.
- Refer to the model specifications for nominal conditions. (Power source and Ambient temperature, etc)
- Sound levels can be increased in accordance with installation and operating conditions. (Operating conditions include some functional condition like Static pressure mode, air guide use, Room target temperature setting, etc and these functions are different in accordance with each model.)
- Sound level will vary depending on a range of factors such as the construction(acoustic absorption coefficient) of particular room in which the equipment is installed.
- Sound pressure level is measured on the rated condition in the anechoic rooms by ISO 3745 standard. Therefore, these values can be increased owing to ambient conditions during operation.

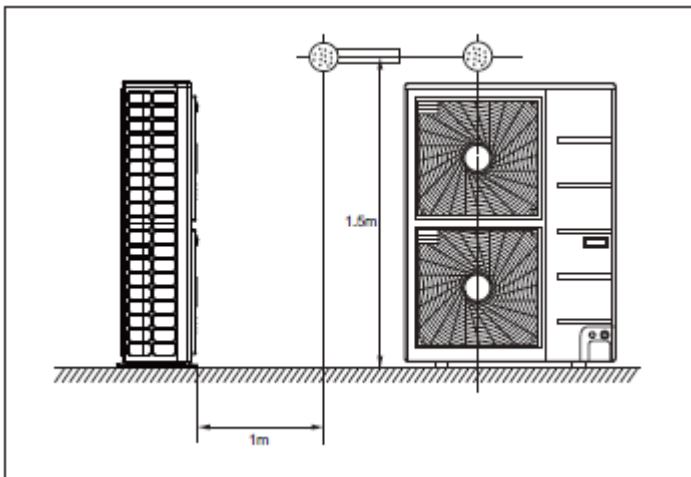

10. AVUW60GM2P1 + AVNW60GM2P1

10.1 Specifications

Category		Unit	Specification
Major	Minor		
Classification	Chassis	-	U60A
	Cooling / Heating	-	H/P
Power Supply	Case 1	-	220, 1, 60
	Case 2	-	-
	Limit Range of Voltage(Case 1)	V	187-276
	Limit Range of Voltage(Case 2)	V	-
Cooling Capacity	Rated	kW	15.24
		Btu/h	52,000
	Min ~ Max	kW	6.00~16.70
		Btu/h	20,500~57,000
	Sensible	kW	11.05
		Btu/h	37,700
Heating Capacity	Rated	kW	17.00
		Btu/h	58,000
	Min ~ Max	kW	6.80~18.20
		Btu/h	23,200~62,100
Power Input(Cooling)	Rated	kW	4.95
	Min ~ Max	kW	~
Power Input(Heating)	Rated	kW	5.60
	Min ~ Max	kW	~
Efficiency	EER	W/W	3.08
	COP	W/W	3.04
	SEER	Wh/Wh	6.12
Running Current(Cooling)	Rated	A	22.50
	Min/Max	A	- / -
Running Current(Heating)	Rated	A	25.50
	Min/Max	A	- / -
Running Current	Max	A	27.00
Power Factor(Cooling/Heating)	Rated	-	0.99 / 0.99
Outdoor Fan	Type	-	Propeller
	Air Flow Rate(Max)	m ³ /min x No.	60 x 2
	Max. External Static Pressure	Pa	-
Outdoor Fan Motor	Type	-	BLDC
	Drive	-	-
	Output	W x No.	124.2 x 2
Compressor	Type	-	Twin Rotary
	Model x No.	-	GPT442MAB X 1
	Motor Type	-	BLDC
	Motor Output	W x No.	4000 X 1
	Oil Type	-	PVE
	Oil Charging amount	cc x No.	1300 X 1
Heat Exchanger	Rows x Columns x FPI	-	2 x 32 x 14
	No.	-	2
	Fin Type	-	Wide Louver Plus
	Corrosion Protection (Coating)	-	-
	Material (Tube / Fin)	-	-
	Face Area	m ²	-
Dimensions	Net(W x H x D)	mm	950 x 1,380 x 330
	Shipping(W x H x D)	mm	1,140 x 1,462 x 461
Weight	Net	kg	91.3

10. AVUW60GM2P1 + AVNW60GM2P1

Category		Unit	Specification
Major	Minor		
Weight	Shipping	kg	101.3
Exterior	Color	-	Warm Gray
	RAL (Classic)	-	RAL 7044
Protection Device	High Pressure Prevention	-	-
	Frost Prevention	-	-
	Discharge Temperature Control	-	-
	Inverter Protection	-	-
Refrigerant	Type	-	R410A
	Precharged Amount	kg	3.400
	Additional Charging amount	g/m	40
	GWP(Global Warming Potential)	-	2,087.5
	t-CO ₂ eq.	-	7.098
	Chargeless-Pipe Length	m	7.5
	Control Type	-	EEV
Connecting Pipe	Liquid	mm(inch)	Φ9.52 (3/8)
	Gas	mm(inch)	Φ19.05 (3/4)
Pipe Connecting Socket	Liquid	mm(inch)	Φ9.52 (3/8)
	Gas	mm(inch)	Φ19.05 (3/4)
	Connection Type(Liquid)	-	Flare
	Connection Type(Gas)	-	Flare
Piping Length Limit	IDU - ODU(Rated / Max / Min)	m	5 / 50 / 5
Maximum Height Difference	IDU - ODU(Max)	m	30
Sound Pressure Level (Outdoor Unit)	Cooling / Heating (@ 1.5m height)	dB(A)	55.0 / 57.0
Measurement Standard (Pressure Level)	-	-	ISO 3745
Sound Power Level (Outdoor Unit)	Cooling / Heating	dB(A)	-
Measurement Standard (Power Level)	-	-	-
Connecting Cable	Power Supply Cable(H07RN-F)	mm ² × cores	6.0 × 3C
Electrical Characteristic	Minimum Circuit Amperes (MCA)	A	34.3
	Maximum Fuse Amperes (MFA)	A	40
	Comp_Rated Load Amperes (Max)	A	25.6
	Outdoor Fan Motor_Full Load Amperes (FLA)	A	1.02

Note

- Due to our policy of innovation some specifications may be changed without notification.
- Wiring cable size must comply with the applicable local and national codes. And "Electric characteristics" should be considered for electrical work and design. Especially the power cable and circuit breaker should be selected in accordance with that.
- Power factor could vary less than ±1% according to the operating conditions.
- Sound level values are depend on the ambient conditions and values are normally higher in actual operation.
- This product contains Fluorinated greenhouse gases.
- Voltage supplied to the unit terminals should be within the minimum and maximum range.
- Maximum allowable voltage unbalance between phase is 2%.
- MSC means the Max. current during the starting of compressor.
- MSC and RLA are measured as the compressor only test condition.
- OFM and IFM are measured as the outdoor unit test condition.
- Select the wire size based on MCA.
- MFA is used to select the circuit breaker and ground fault circuit interrupter, and all installation site must require attachment of an earth leakage breaker. [circuit breaker type is ELCB(Earth Leakage Circuit Breaker)].
- Performances are based on the following conditions :
 - Cooling : Indoor Ambient Temp. 27°CDB / 19°CWB, Outdoor Ambient Temp. 35°CDB / 24°CWB
 - Heating : Indoor Ambient Temp. 20°CDB / 15°CWB, Outdoor Ambient Temp. 7°CDB / 6°CWB
 - Interconnected Pipe Length is standard length and difference of Elevation (Outdoor ~ Indoor Unit) is 0m.

10. AVUW60GM2P1 + AVNW60GM2P1**10.2 List of Functions**

Category	Functions	Availability
Reliability	Defrost / Deicing	O
	High Pressure Switch	X
	Low Pressure Switch	X
	Phase Protection	X
	Restart Delay (3-minutes)	O
	Self Diagnosis	O
	Soft Start	O
Convenience	Night Low Noise Operation	O
	Wiring Error Check	X
	Peak Control	O
	Mode Lock	O
	Forced Cooling Operation (Outdoor Unit)	X
	Advanced SLC (Smart Load Control)	X
Special Functions	ODU Dry Contact Function	X

Note

■ O : Applied, X : Not applied

- Accessory : Ordered and purchased separately the accessory package referring to the model name provided and install at field.
- Accessory line-ups varies by region, so check your local catalogue or local sales material.

10. AVUW60GM2P1 + AVNW60GM2P1**10.3 Accessory Compatibility List**

Category	Accessory Name	Model Name	Description	Compatibility
Central Controller	AC EZ	PQCSZ250S0	-	O
	AC EZ touch	PACEZA000	Touch type	O
	AC Smart IV	PACS4B000	Touch type	O
	AC Smart 5	PACS5A000	Touch type	O
	ACP IV	PACP4B000	-	O
	ACP 5	PACP5A000	-	O
	AC Manager IV	PACM4B000	For Integrated Control	O
	AC Manager 5	PACM5A000	For Integrated Control	O
Gateway	ODU PI485	PMNFP14A1	For 16-room (3 series)	O
	ACP BACnet	PQNFB17C0	-	O
	ACP Lonwork	PLNWKB000	-	O
	Cloud Gateway	PWFMDB200	-	O
Integration Device	AHU comm. kit	PAHCMR000	For AHU Control (Multi V / Single ODU Communication)	O
		PAHCMS000	For AHU Control (Multi V / Single ODU Communication)	X
	AHU Controller Module	PAHCMC000	For AHU Control (Communication Module)	X
		PAHCMM000	For AHU Control (Main Module)	X
	PDI Standard	PPWRDB000	Power distributor 2port	X
	PDI Premium	PQNUD1S40	Power distributor 8port	X

Note

- O: Possible, X: Impossible, -: Unconfirmed or irrelevant
- AC Manager requires ACP or AC Smart.
- Compatibility of individual controller(wireless/wired remote controller) could be found with function list on Indoor Unit's PDB.
- If you need more detail, please refer to the Control(BECON) PDB or the manual of product.
(<http://partner.lge.com/global> : Home> Doc.Library> Product > Control(BECON)).
- Accessory line-ups varies by region, so check your local catalogue or local sales material.

10. AVUW60GM2P1 + AVNW60GM2P1

10.4 Dimensions

10.4.1 Product

[Unit: mm]
 Chassis code : U60A
 DWG No. : TBA36228001_rev01

Note

- Unit should be installed in compliance with the installation manual in the product box.
- Unit should be grounded in accordance with the local regulations or applicable national codes.
- All electrical components and materials to be supplied from the site must comply with the local regulations or international codes.
- Electric characteristics chapter should be considered for electrical work and design. Especially the power cable and circuit breaker should be selected in accordance with that.

Symbols

- Piping Direction
- Datum line

No.	Part Name	Description
5	Handle	-
4	Liquid Pipe Connection	Flare joint
3	Gas Pipe Connection	Flare joint
2	Power and communication cable Hole	-
1	Air Outlet	-

10. AVUW60GM2P1 + AVNW60GM2P1

10.4.2 Install Space

For Side Discharge (capacity < 28.0 kW)

Obstacle on the Suction side

[Unit : mm(inch)]

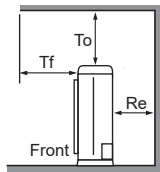

To ≥ 1,000(39-3/8)
Tf ≤ 500(19-11/16)

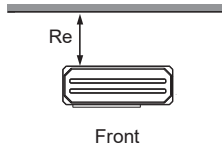

Case 1
Re ≥ 100(3-15/16)
Case 2
Re ≥ 300(11-13/16)

※ Case 1 : No obstacle on top side
Case 2 : Obstacle on top side

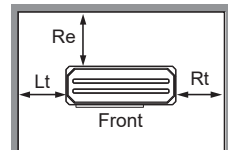

Case 1
Re ≥ 100(3-15/16)
Lt ≥ 100(3-15/16)
Rt ≥ 100(3-15/16)
Case 2
Re ≥ 300(11-13/16)
Lt ≥ 150(5-29/32)
Rt ≥ 150(5-29/32)

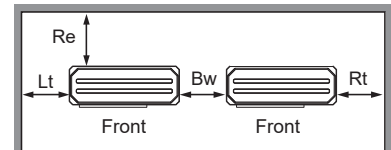

Case 1
Re ≥ 300(11-13/16)
Lt ≥ 1,000(39-3/8)
Rt ≥ 200(7-7/8)
Bw ≥ 100(3-15/16)
Case 2
Re ≥ 300(11-13/16)
Lt ≥ 1,000(39-3/8)
Rt ≥ 200(7-7/8)
Bw ≥ 100(3-15/16)

Obstacle on the Discharge side

※ For Rear Piping / External SVC Valve type / Side-CBOX type
: Re, Lt ≥ 300(11-13/16) and Rt, Bw, Rb ≥ 600(23-5/8) for ALL CASE.

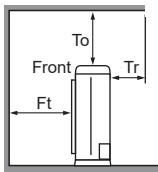
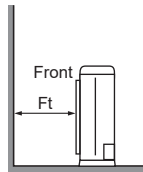

To ≥ 1,000(39-3/8)
Tr ≤ 500(19-11/16)

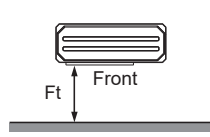

Case 1
Ft ≥ 500(19-11/16)
Case 2
Ft ≥ 500(19-11/16)

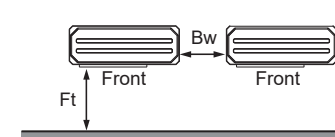

Case 1
Ft ≥ 1,000(39-3/8)
Bw ≥ 100(3-15/16)
Case 2
Ft ≥ 1,000(39-3/8)
Bw ≥ 100(3-15/16)

Obstacle on the Suction and Discharge side

Ld > H (Ls should be lower H.)

※ Close the bottom of the installation frame to prevent the discharged air from being bypassed

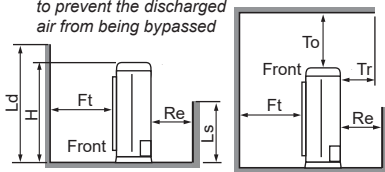

To ≥ 1,000(39-3/8)
Tf ≤ 500(19-11/16)

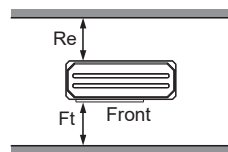

Case 1
Ft ≥ 500(19-11/16)
Re ≥ 300(11-13/16)
Case 2
Ft ≥ 1,000(39-3/8) *
Re ≥ 300(11-13/16)
* If Ls ≤ H/2,
Ft ≥ 750(29-17/32)

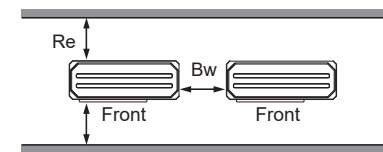

Case 1
Ft ≥ 1,000(39-3/8)
Re ≥ 300(11-13/16)
Bw ≥ 100(3-15/16)
Case 2
Ft ≥ 1,250(49-7/32)
Re ≥ 300(11-13/16)
Bw ≥ 100(3-15/16)

Ld ≤ H

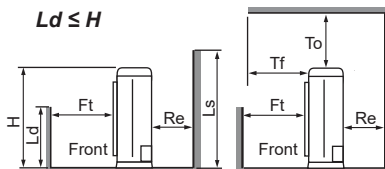

To ≥ 1,000(39-3/8)
Tf ≤ 500(19-11/16)

Case 1
Ft ≥ 500(19-11/16)
Re ≥ 300(11-13/16)
Case 2
Ft ≥ 1,000(39-3/8)
Re ≥ 300(11-13/16)

Case 1
Ft ≥ 1,500(59-1/16)
Re ≥ 300(11-13/16)
Bw ≥ 100(3-15/16)
Case 2
Ft ≥ 1,500(59-1/16)
Re ≥ 300(11-13/16)
Bw ≥ 100(3-15/16)

※ In case of series installation (2 Units or more) for 2 Fan models, Ld should be lower than H/2.

Collective/Continuous Installation (Multiple Columns)

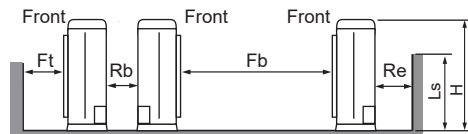

※ In case of Multiple columns/continuous installation, Ls should be lower than H.

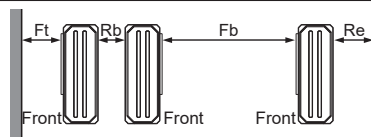

1 Column

Ft ≥ 1,000(39-3/8)
Rb ≥ 200(7-7/8)
Fb ≥ 2,000(78-3/4)
Re ≥ 100(3-15/16)

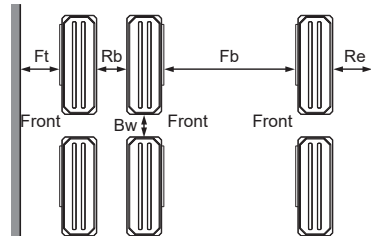

Multiple Columns

Ft ≥ 1,500(59-1/16)
Rb ≥ 600(23-5/8)
Fb ≥ 3,000(118-1/8)
Re ≥ 300(11-13/16)
Bw ≥ 100(3-15/16)

Note

- If there is a concern about product performance degradation due to group installation or interference with obstacles, secure an additional separation distance.
- Secure enough space for smooth service and maintenance.
- According to product type, model line up, sales region..etc, applicability of each chassis could be different.

10. AVUW60GM2P1 + AVNW60GM2P1

10.5 Piping Diagrams

10.5.1 Normal

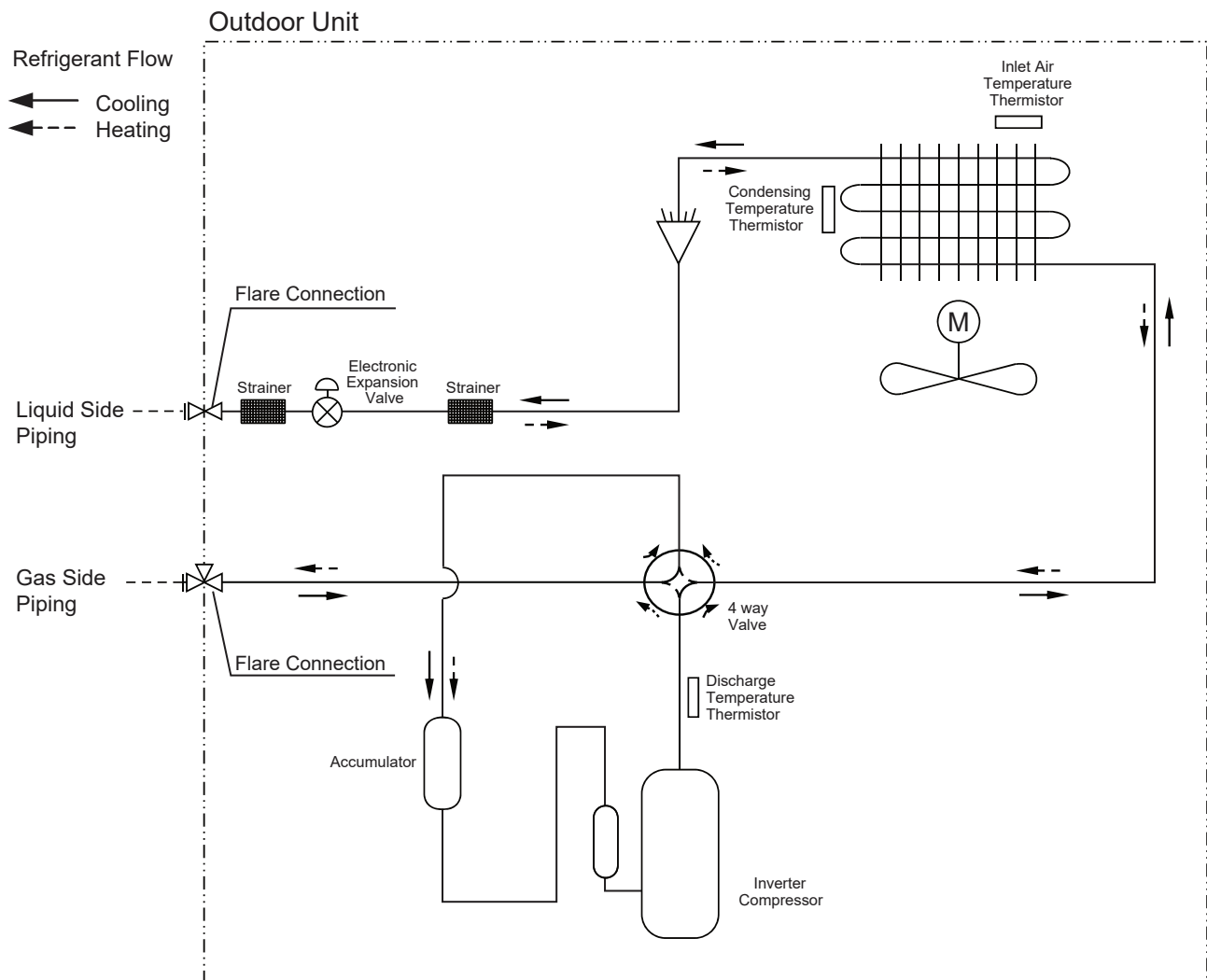

10. AVUW60GM2P1 + AVNW60GM2P1

10.6 Wiring Diagrams

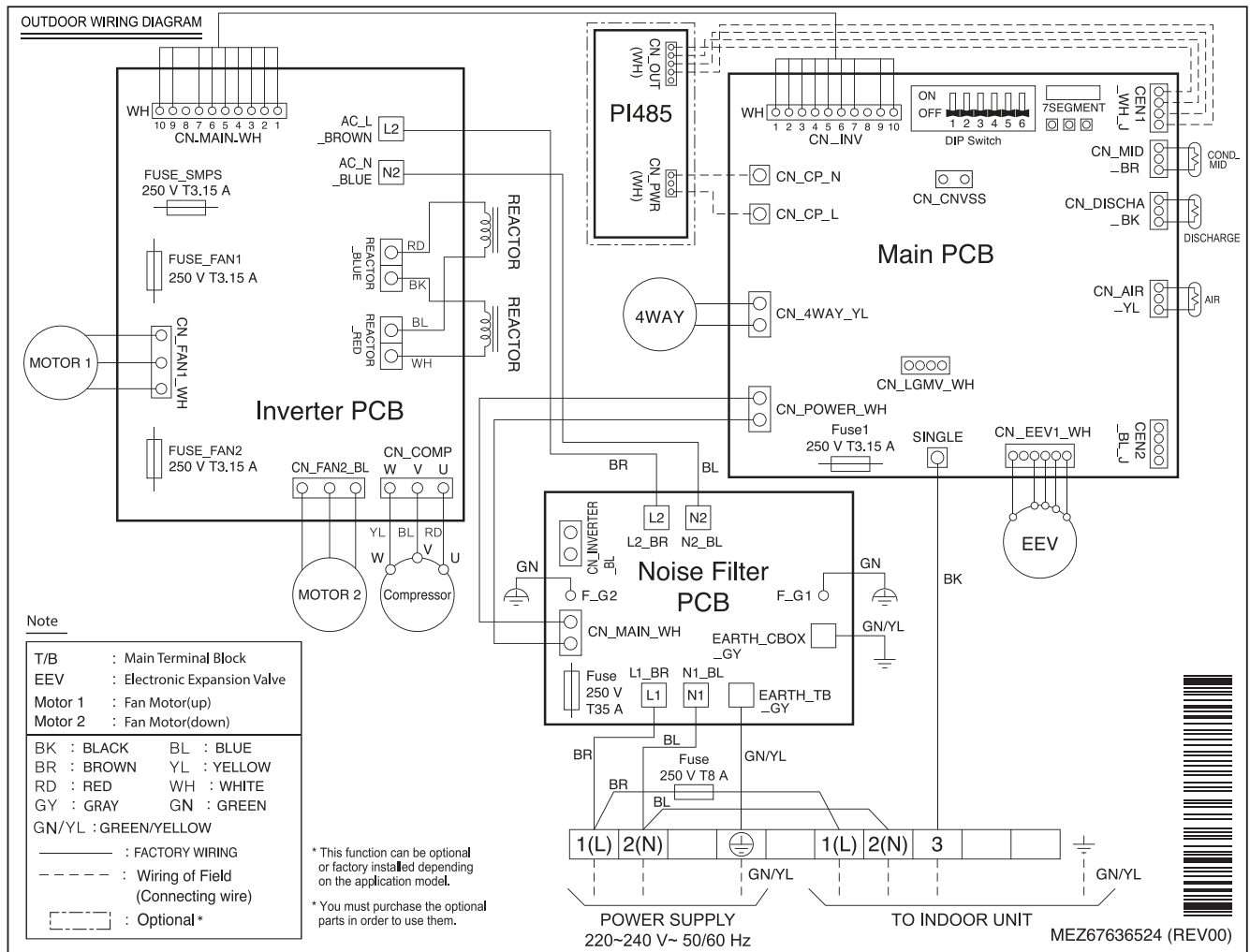

10. AVUW60GM2P1 + AVNW60GM2P1

10.7 Capacity Tables

10.7.1 Cooling

Outdoor Air Temp. (°C, DB)	Indoor Air Temp. (°C, DB/WB)																				
	20.0 / 14.0			22.0 / 16.0			25.0 / 18.0			27.0 / 19.0			28.0 / 20.0			30.0 / 22.0			32.0 / 24.0		
	TC	SHC	PI	TC	SHC	PI	TC	SHC	PI	TC	SHC	PI	TC	SHC	PI	TC	SHC	PI	TC	SHC	PI
20	8.95	7.45	2.02	11.64	8.89	2.53	13.68	10.33	2.93	15.24	11.05	3.21	15.76	10.98	3.24	16.80	10.84	3.31	17.98	10.70	3.33
25	8.95	7.45	2.38	11.64	8.89	2.98	13.68	10.33	3.46	15.24	11.05	3.79	15.76	10.98	3.83	16.80	10.84	3.91	17.98	10.70	3.93
32	8.95	7.45	2.89	11.64	8.89	3.62	13.68	10.33	4.20	15.24	11.05	4.60	15.76	10.98	4.65	16.80	10.84	4.74	17.98	10.70	4.77
35	8.95	7.45	3.10	11.64	8.89	3.90	13.68	10.33	4.51	15.24	11.05	4.95	15.76	10.98	5.00	16.80	10.84	5.10	17.98	10.70	5.13
40	8.95	7.45	3.34	11.64	8.89	4.19	13.68	10.33	4.85	15.24	11.05	5.32	15.76	10.98	5.37	16.80	10.84	5.48	17.98	10.70	5.51
43	8.95	7.45	3.48	11.64	8.89	4.36	13.68	10.33	5.05	15.24	11.05	5.54	15.76	10.98	5.60	16.80	10.84	5.71	17.98	10.70	5.74
46	8.95	7.45	3.62	11.64	8.89	4.55	12.41	9.43	5.19	12.66	9.28	5.29	13.09	9.21	5.34	13.96	9.08	5.45	14.94	8.95	5.48
48	8.95	7.45	3.77	11.64	8.89	4.74	11.92	9.06	5.04	12.17	8.98	5.14	12.51	8.86	5.19	13.19	8.63	5.30	13.98	8.41	5.33
50	8.95	7.45	3.93	11.20	8.65	4.80	11.43	8.78	4.90	11.67	8.68	5.00	11.92	8.51	5.05	12.42	8.18	5.15	13.02	7.87	5.18
52	8.95	7.45	4.09	10.72	8.37	4.66	10.94	8.50	4.75	11.17	8.37	4.85	11.33	8.15	4.90	11.65	7.71	5.00	12.06	7.32	5.02
54	8.95	7.45	4.27	10.25	8.09	4.52	10.45	8.21	4.61	10.67	8.06	4.70	10.74	7.79	4.75	10.88	7.24	4.84	11.10	6.77	4.87

Note

- DB : Dry bulb temperature(°C), WB : Wet bulb temperature(°C)
- TC : Total Capacity(kW), SHC : Sensible Heat Capacity(kW)
- PI : Power Input (kW, Compressor + indoor fan motor + outdoor fan motor)
- All capacities are net. A deduction of capacity due to operating heat of indoor unit motor is reflected.
- Direct interpolation is permissible. Do not extrapolate.
- Rated capacities and power inputs are based on standard temperature and piping conditions, and it can be found on specifications table.
Except for rated value, the performance is not guaranteed.
- In accordance with the test standard(or nations), the rating will vary slightly.

10. AVUW60GM2P1 + AVNW60GM2P1

10.7.2 Heating

Outdoor Air Temp. (°C, WB)	Indoor Air Temp. (°C, DB)									
	16.0		18.0		20.0		22.0		24.0	
	TC	PI	TC	PI	TC	PI	TC	PI	TC	PI
-5.0	15.47	4.85	15.39	5.32	15.30	5.79	15.22	6.25	15.15	6.72
0.0	17.17	5.79	17.09	6.25	17.00	6.72	16.32	6.34	15.64	5.96
6.0	18.82	6.16	17.91	5.88	17.00	5.60	16.32	5.32	15.64	5.04
10.0	18.82	5.79	17.91	5.32	17.00	4.85	16.32	4.64	15.64	4.43
15.0	18.82	4.85	17.91	4.39	17.00	3.92	16.32	3.79	15.64	3.67
18.0	18.82	4.29	17.91	3.83	17.00	3.36	16.32	3.28	15.64	3.21

Note

- DB : Dry bulb temperature(°C), WB : Wet bulb temperature(°C)
- TC : Total Capacity(kW)
- PI : Power Input (kW, Compressor + indoor fan motor + outdoor fan motor)
- All capacities are net. An addition of capacity due to operating heat of indoor unit motor is reflected.
- Direct interpolation is permissible. Do not extrapolate.
- Rated capacities and power inputs are based on standard temperature and piping conditions, and it can be found on specifications table.
Except for rated value, the performance is not guaranteed.
- In accordance with the test standard(or nations), the rating will vary slightly.

10. AVUW60GM2P1 + AVNW60GM2P1

10.8 Capacity Correction Factor

Operation	Capacity correction factor (%) by Equivalent pipe length (m)										
	5	7.5	10	15	20	25	30	35	40	45	50
Cooling	100.0	99.6	99.3	97.9	96.6	95.2	93.8	92.4	91.1	89.8	88.4
Heating	100.0	99.9	99.7	99.2	98.7	98.2	97.7	97.1	96.6	96.1	95.6

Note

In Order to estimate the actual system capacity, the influence of various installation conditions should be reflected.

Reflect the capacity correction factor effect of piping installation as below.

- Qodu [from specification table] : Outdoor unit standard capacity.
- Q(Ti, To) [from capacity table] : Outdoor unit capacity at Ti, To temperature.
- F(Ti, To) = Q(Ti, To) / Qodu. : Outdoor unit capacity correction factor
- Fpiping for piping length [from capacity correction factor table] : Piping correction factor
- Indoor unit actual capacity : Qactual = Qodu x F(Ti, To) x Fpiping

10. AVUW60GM2P1 + AVNW60GM2P1

10.9 Operation Limits

10.9.1 Cooling

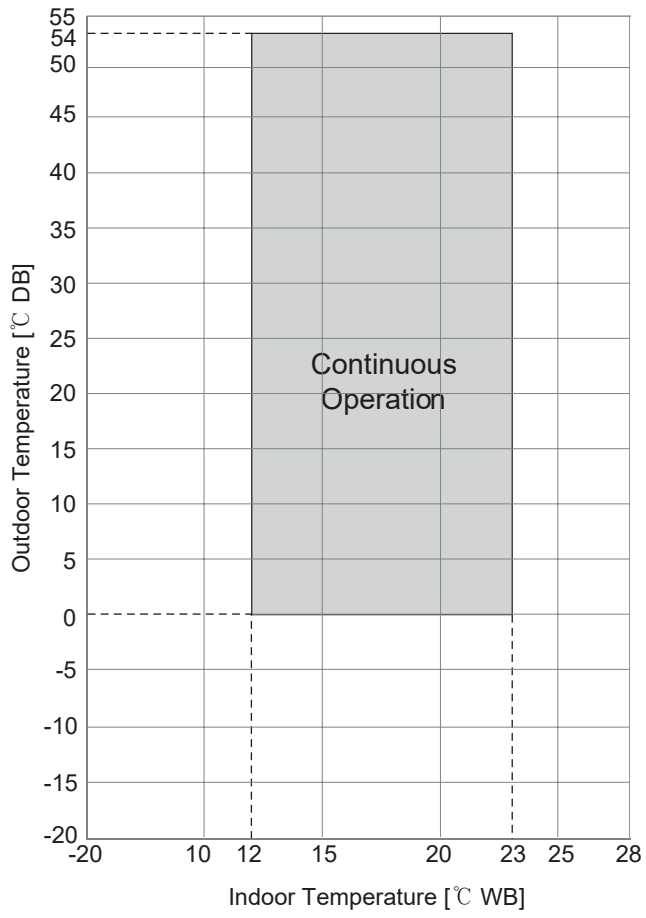

10. AVUW60GM2P1 + AVNW60GM2P1

10.9.2 Heating

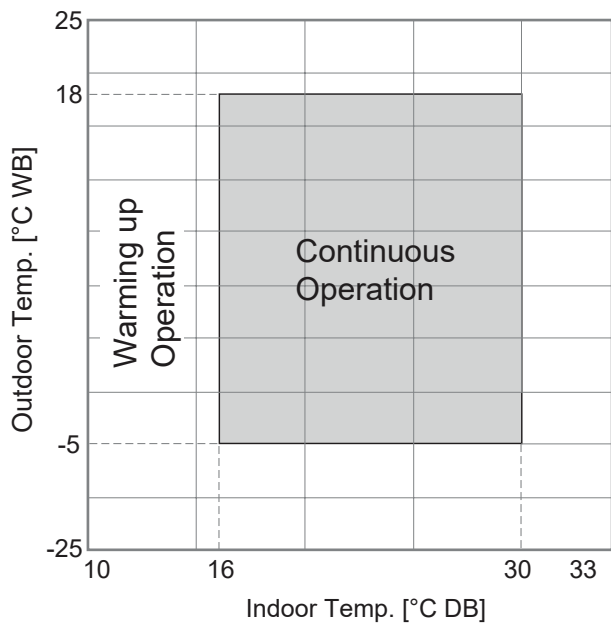

Note

- Warming up operation and operative mean that the outdoor unit operates to reach the range of continuous operating, however it may not operate continuously due to safety or protection logic.

10. AVUW60GM2P1 + AVNW60GM2P1

10.10 Sound Levels

10.10.1 Pressure Levels

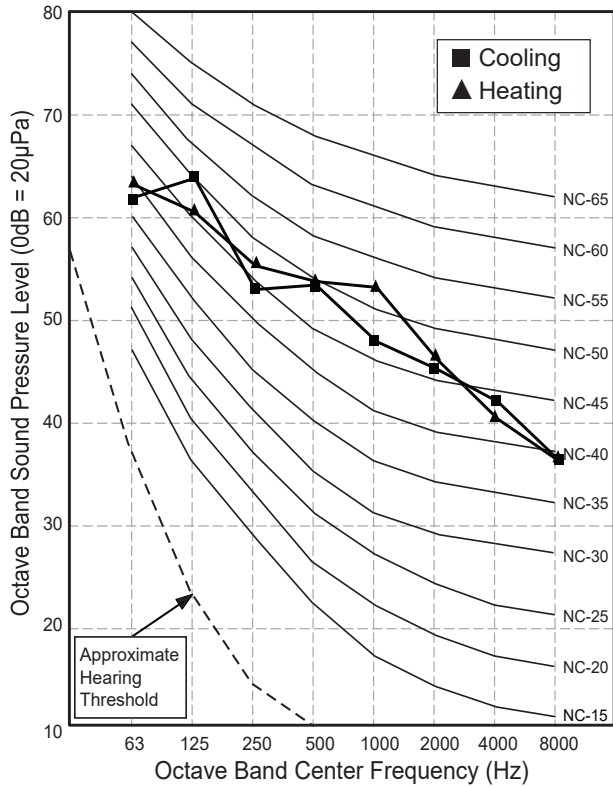

Sound level [dB(A), @ Standard condition]	
Cooling / Heating (@ 1.5m height)	55.0 / 57.0

Note

- Data is valid at diffuse field condition.
- Data is valid at nominal operating condition.
- Reference acoustic pressure 0dB = 20µPa.
- Refer to the model specifications for nominal conditions. (Power source and Ambient temperature, etc)
- Sound levels can be increased in accordance with installation and operating conditions. (Operating conditions include some functional condition like Static pressure mode, air guide use, Room target temperature setting, etc and these functions are different in accordance with each model.)
- Sound level will vary depending on a range of factors such as the construction(acoustic absorption coefficient) of particular room in which the equipment is installed.
- Sound pressure level is measured on the rated condition in the anechoic rooms by ISO 3745 standard. Therefore, these values can be increased owing to ambient conditions during operation.

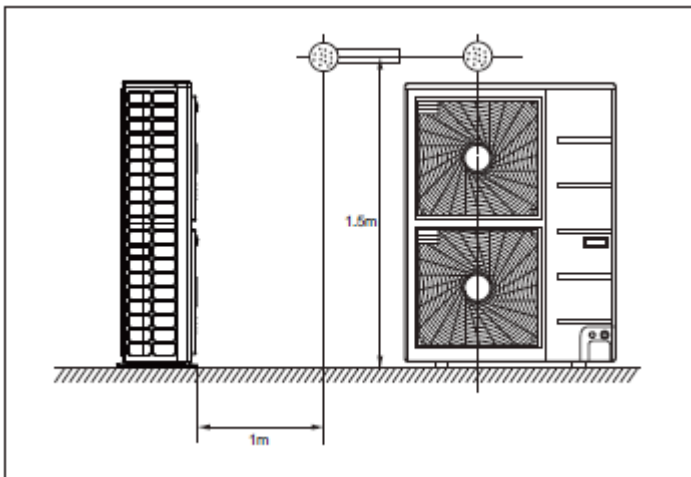

Installation

Installation of Outdoor Unit

1. Information for Refrigerant

1.1 Alternative Refrigerant

The type of refrigerant applied depends on the outdoor unit cycle configuration. Ensure the refrigerant type in the specification of the indoor unit and outdoor unit to be installed.

■ Alternative Refrigerant _ R410A

- The refrigerant R410A has the property of higher operating pressure in comparison with R22. Therefore, all materials have the characteristics of higher resisting pressure than ones of R22 and this characteristic should also be considered during the installation.
- The wall thickness of the piping should comply with the relevant local and national regulations for the designed pressure. (R410A 3.8MPa)
- For high-pressure refrigerant, any unapproved pipe must not be used.
- Do not heat pipes more than necessary to prevent them from softening.
- Do not place the refrigerant container under the direct rays of the sun to prevent it from exploding.
- R410A is an azeotrope of R32 and R125 mixed at 50:50, so the ozone depletion potential(ODP) of R410A is 0.
- Since R410A is a mixed refrigerant, the required additional refrigerant must be charged in its liquid state.
If the refrigerant is charged in its gaseous state, its composition changes and the system will not work properly.
- Be careful not to install wrongly to minimize economic loss because it is expensive in comparison with R22.

1. Information for Refrigerant

1.2 Caution For Refrigerant Leaks

< Needs to Calculation of Refrigeran concentration >

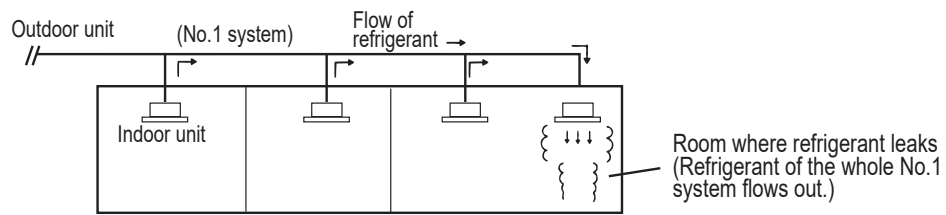

< Calculation of Room Space >

□ : Range ov Room space

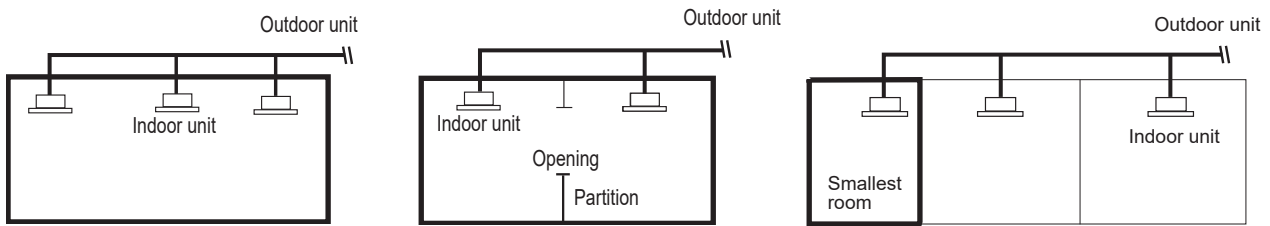

In the case of opening without door, or openings both above and below door which is more than 0.15 % to floor space)

< Countermeasure when concentration is exceed >

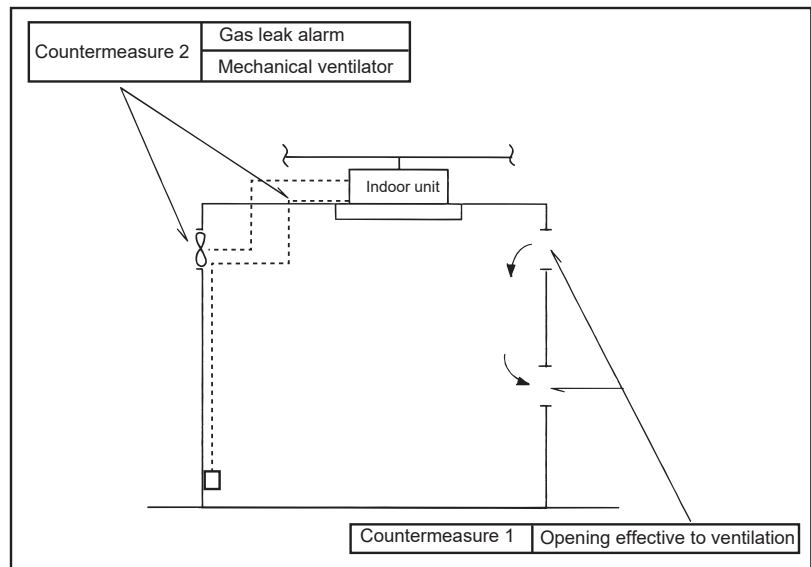

The installer and system specialist shall secure safety against leakage according to local regulations or standards. The following standards may be applicable if local regulations are not available.

■ Concentration limit : 0.44 kg/m³ (for R410A)

Concentration limit (Freon gas weight per unit air volume, kg/m³) is the limit of Freon gas concentration where immediate measures can be taken without hurting human body when refrigerant leaks in the air.

■ Calculate refrigerant concentration

Check concentration limit along following steps and take appropriate measure depending on the situation.

(1) Calculate total amount of refrigerant per each system (A, kg)

Total amount of refrigerant in the system (A, kg)

= Amount of pre-charged refrigerant per single system(B, kg) + Amount of additional replenished refrigerant(C, kg)

(B : Amount of replenished refrigerant at factory shipment)

(C : Amount of additionally replenished refrigerant depending on piping length or piping diameter by customer)

1. Information for Refrigerant

※ In case one refrigerant facility is divided into 2 or more refrigerant systems and each system is independent, amount of replenished refrigerant of each system shall be adopted.

(2) Calculate the volume of the room where indoor unit is installed as single room or the smallest room. (D, m³)

In case of room with partition and without opening which serve as passage of air to adjoining room, calculate the room space only.

- In case of room with partition but opened which serve passage of air to adjoining room, calculate the room space include space of adjoining room. (In the case of opening without door, or openings both above and below door which is more than space 0.15 % to floor space)

(3) Calculate refrigerant concentration.

Refrigerant concentration

= Total amount of refrigerant system (A, kg) ÷ Volume of smallest room where indoor unit is installed (D, m³)

[Refrigerant concentration ≤ Maximum concentration (kg/m³, R410A is 0.44)]

In case the result of calculation exceeds the concentration limit, perform the same calculations by shifting to the second smallest, and the third smallest rooms until at last the result is below the concentration limit.

■ In case the concentration exceeds the limit

When the concentration exceeds the limit, change original plan or take one of the counter measure shown below:

- Counter measure 1

Provide opening 0.15% or more size of opening to floor space both above and below door for ventilation, or provide opening without door.

- Counter measure 2

Provide gas leak alarm linked with mechanical ventilator.

- Counter measure 3

Reducing the system's refrigerant quantity by deviding into smaller separate system.

< ! > CAUTIONS

Pay a special attention to the place, such as a basement, etc. where refrigerant can stay, since refrigerant is heavier than air.

2. Selection of the best Location

2.1 Best Location

Select space for installing outdoor unit, which will meet the following conditions:

- No direct thermal radiation from other heat sources.
- No possibility of annoying neighbors due to noise of unit.
- No exposition to strong wind.
- Place with strength which bears weight of unit.
- Note that drain flows out of unit when heating mode operation (except for Cooling only model).
- Because of the possibility of fire, do not install unit to the space where generation, inflow, stagnation, and leakage of combustible gas is expected.
- Avoid unit installation in a place where acidic solution and spray (sulfur) are often used.
- Do not use unit under any special environment where oil, steam and sulfuric gas exist.
- It is recommended to fence round the outdoor unit in order to prevent any person or animal from accessing the outdoor unit.
- If installation site is area of heavy snowfall, then the following directions should be observed.
 - Make the foundation as high as possible / Fit a snow protection hood.
- Select installation location considering following conditions to avoid bad condition when performing defrost operation.
 - Install the unit at a place well ventilated and having a lot of sunshine in case of installing the product at a place with a high humidity in winter (near beach, coast, lake, etc).
(Ex) Rooftop where sunshine always shines.
 - Performance of heating will be reduced and pre-heat time of the indoor unit may be lengthened in case of installing the outdoor unit in winter at following location:
 - ▷ Shade position with a narrow space.
 - ▷ Location with much moisture in neighboring floor.
 - ▷ Location with much humidity around.
It is recommended to install the outdoor unit at a place with a lot of sunshine as possible as.
 - ▷ Location where liquid gathers since the floor is not even.
 - ▷ When installing the outdoor unit in a place that is constantly exposed to a strong wind like a coast or on a high story of a building, secure a normal fan operation by using a duct or a wind shield.

■ Cautions corresponding to strong/seasonal wind

- When the "Outdoor unit of Side Discharge Type" is installed in a place that is constantly exposed to a strong wind like a coast or on a high story of a building, secure a normal fan operation by using a duct or a wind shield.
 - Don't install the suction hole and discharge hole of the Outdoor unit facing the seasonal wind.
 - Install the unit so that its discharge port faces to the wall of the building.
Keep a distance 500mm or more between the unit and the wall surface.
 - Supposing the wind direction during the operation season of the air conditioner, install the unit so that the discharge port is set at right angle to the wind direction.

■ Cautions in winter

- Sufficient measures are required in a snow area or severe cold area in winter so that product can be operated well.
- Get ready for seasonal wind or snow in winter even in other areas.
- Install a suction and discharge duct not to let in snow or rain.
- Install the outdoor unit not to come in contact with snow directly. If snow piles up and freezes on the air suction hole, the system may malfunction. If it is installed at snowy area, attach the hood to the system.
- Where snow accumulated on the upper part of the Outdoor Unit, always remove snow for operation.
- If width of the frame is wider than that of the product, snow may accumulate. So, its width shall not exceed the width of the product.

2. Selection of the best Location

2.2 Special guide for installation at the Seaside

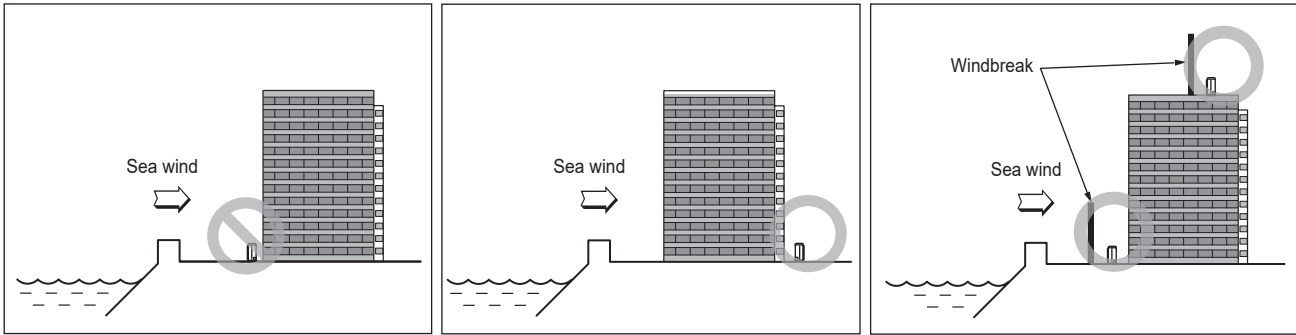

※ This figure is representative. Actual appearance of outdoor unit may be different by product type.

< ! > CAUTIONS

- Air conditioners should not be installed in areas where corrosive gases, such as acid or alkaline gas, are produced.
- Do not install the product where it could be exposed to sea wind (salty wind) directly. It can result corrosion on the product. Corrosion, particularly on the condenser and evaporator fins, could cause product malfunction or inefficient performance.
- If outdoor unit is installed close to the seaside, it should avoid direct exposure to the sea wind. Otherwise it needs additional anticorrosion treatment on the heat exchanger.

■ Selecting the location of Outdoor Units

- If the outdoor unit is to be installed close to the seaside, direct exposure to the sea wind should be avoided.
- Install the outdoor unit on the opposite side of the sea wind direction.
- It should be strong enough like concrete to prevent the sea wind from the sea.
- The height and width should be more than 150% of the outdoor unit.
- It should be kept more than 70 cm of space between outdoor unit and the windbreak for easy air flow.
In case, to install the outdoor unit on the seaside, set up a windbreak not to be exposed to the sea wind.
- Select a well-drained place.
- Periodic (more than once/year) cleaning of the dust or salt particles stuck on the heat exchanger by using water.

3. Foundation for Installation

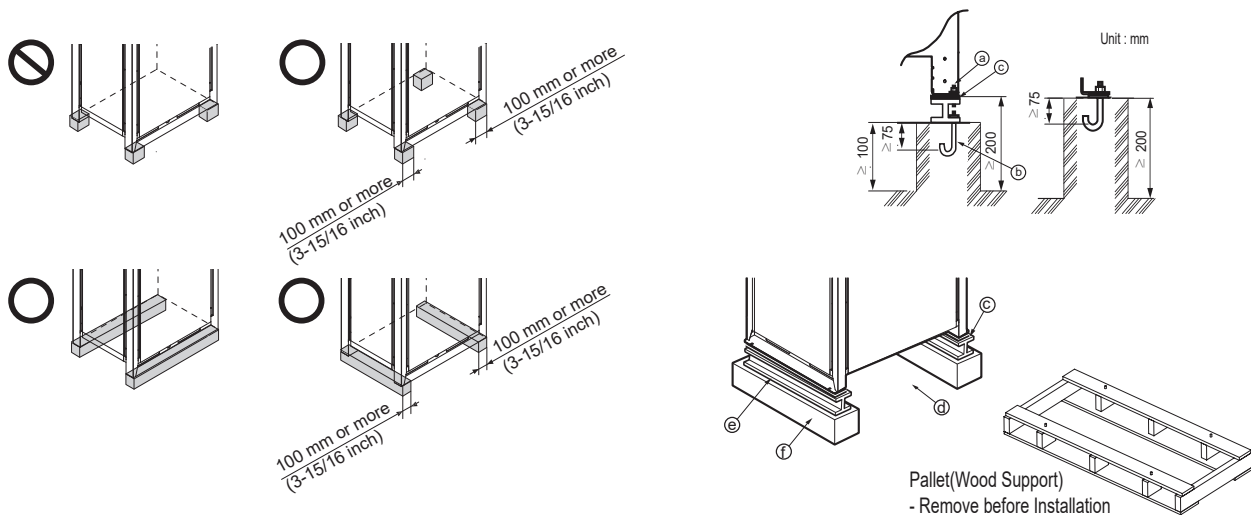

- Install where it can sufficiently support the weight of the outdoor unit.
If the support strength is not enough, the outdoor unit may drop and hurt people.
- Install where the outdoor unit may not fall in strong wind or earthquake.
If there is a fault in the supporting conditions, the outdoor unit may fall and hurt people.
- Please take extra cautions on the supporting strength of the ground, water outlet treatment (treatment of the water flowing out of the outdoor unit in operation), and the passages of the pipe and wiring, when making the ground support.
- Do not use tube or pipe for water outlet in the Base pan. Use drainage instead for water outlet.
The tube or pipe may freeze and the water may not be drained.
- Install at places where it can endure the weight and vibration/noise of the outdoor unit.
- The outdoor unit supports at the bottom shall have width of at least 100mm under the unit's legs before being fixed.
- The outdoor unit supports should have minimum height of 200mm.
- Anchor bolts must be inserted at least 75mm.
- Fix the unit tightly with bolts as shown so that unit will not fall down due to earthquake or gust.
 - a. The corner part must be fixed firmly. Otherwise, the support for the installation may be bent.
 - b. Get and use M10 Anchor bolt.
 - c. Noise and vibration may occur from the floor or wall since vibration is transferred through the installation part depending on installation status. Thus, use anti-vibration materials (cushion pad) fully.
(The base pad shall be more than 200mm)
 - d. Space for pipes and wiring (Pipes and wiring for bottom side)
 - e. Use the H-beam support as a base support
 - f. Concrete support
- Be sure to remove the Pallet (Wood Support) of the bottom of the outdoor unit before fixing the bolt or welding.
It may cause the unstable state of the outdoor settlement, and may cause freezing of the heat exchanger resulting in abnormal operations, hazard of fire during welding.

4. Refrigerant Piping System

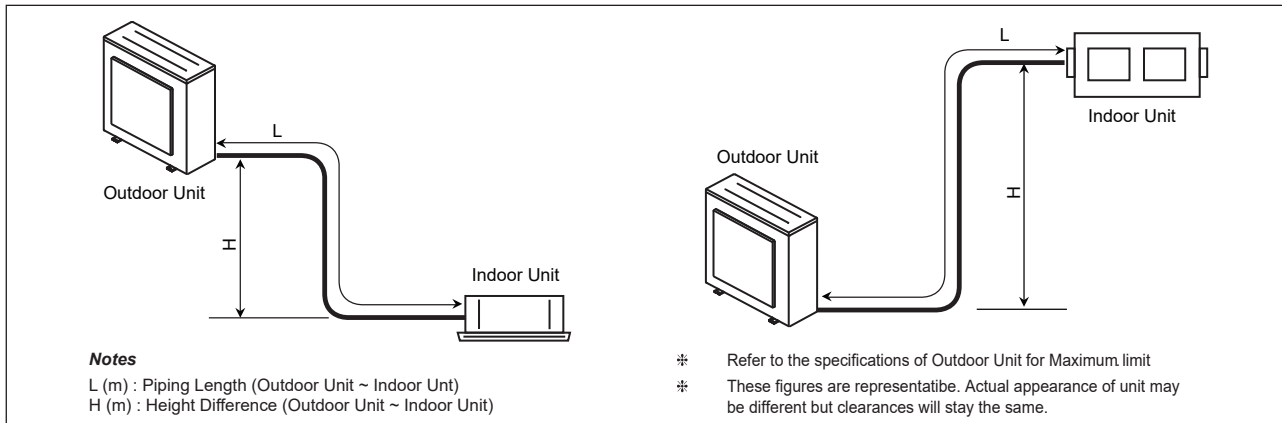

■ Refrigerant additional charge calculation method

• **Additional Refrigerant = (L - A) x a**

- L (m) : Installed Piping Length (Outdoor Unit ~ Indoor Unit)
- A (m) : Charge-less piping length
- a (g/m) : Additional charging volume

* Refer to the specifications for detail information of A, a.

* If total additional charge value after calculation comes out to be negative, then do not consider additional charge.

< ! > CAUTIONS

- Please check the product type. Piping installation and refrigerant charge varies depending on the type of product. For more information, please refer to the installation manual.
- Capacity is based on standard length and maximum allowance length is on the basis of reliability.
- Improper refrigerant charge may result in abnormal cycle.

5. Electrical Wiring

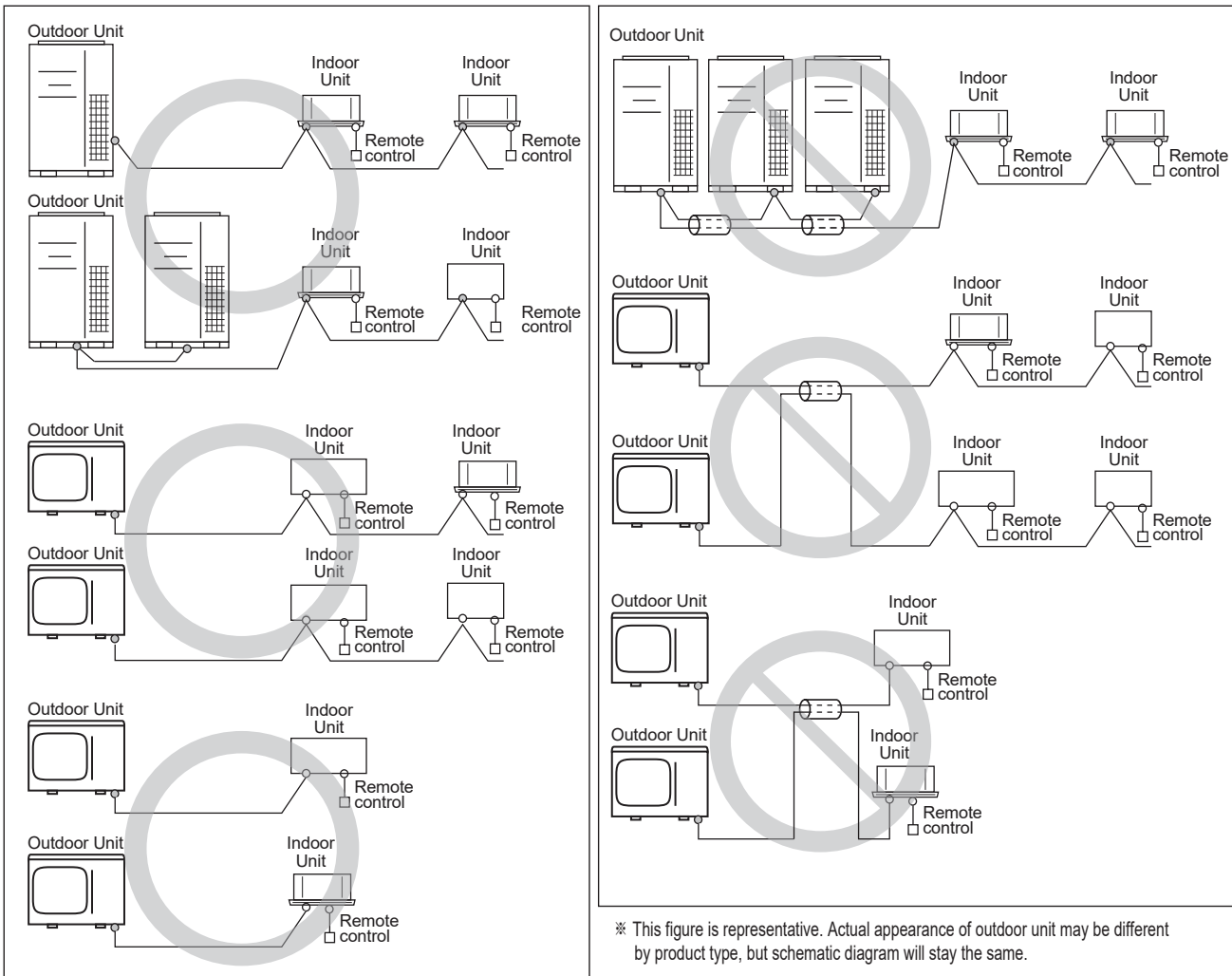

- Follow ordinance of local regulation for technical standard related to electrical equipment, wiring regulations and guidance of each electric power company.
- Be sure to provide designated grounding work to installed unit.
- Give some allowance to wiring for electrical part box of units, because the box is sometimes removed at the time of service work.
- Only the communication line specified should be connected to the terminal block for unit communication.

< ! > WARNING

- Be sure to have authorized electrical engineers do the electric work using special circuits in accordance with regulations and installation manual. If power supply circuit has a lack of capacity or electric work deficiency, it may cause an electric shock or fire.
- Be sure to connect the installed unit to earth. Do not connect earth line to any gas pipe, liquid pipe, lightning rod or telephone earth line. If earth is incomplete, it may cause an electric shock.

< ! > CAUTIONS

- Product which use 3-phase power source have reversed phase protection detector that only works when the power is turned on. If there exists black out or the power goes on and off which the product is operating, attach a reversed phase protection circuit locally. Running the product in reversed phase may break the compressor and other parts.
- Install the communication line away from the power source wiring so that it is not affected by electric noise from the power source. (Do not run it through the same conduit.) Never use them together with power cables.
- Never use multi-core cable.

If communication lines of different systems are wired with the same multiplex cable, the resultant poor transmitting and receiving will cause erroneous operations.

5. Electrical Wiring

- The conductive shielding layer of cable should be grounded to the metal part of both units.
- As this unit is equipped with an inverter, to install a phase leading capacitor not only will deteriorate power factor improvement effect, but also may cause capacitor abnormal heating. Therefore, never install a phase leading capacitor.
- Make sure that the power unbalance ratio is not greater than 2%. If it is greater, the unit's lifespan will be reduced.
- Never connect the main power source to terminal block of communication line.
If connected, electrical parts will be burnt out.
- Introducing with a missing "N" phase or with a mistaken "N" phase will break the equipment.
- When the power supply is applied to "N" phase by mistake, replace inverter PCB and transformer in control box.

Communication and Power Lines

- Communication cable
 - Types : shielded cables
 - Use wires of size : over 1.0 ~ 1.5 mm²
 - Maximum allowable temperature of cable : over 60°C (140°F)
 - Maximum allowable line length: under 1,000m
- Remote control cable
 - Types : 3-core cable
- Central control cable
 - Please check the model function table for compatibility with central controller.

Product Type	Wire Type	Diameter
ACP & AC Manager	2-core cables (Shielded)	1.0~1.5mm ²
AC Smart	2-core cables (Shielded)	1.0~1.5mm ²
Simple central controller	4-core cables (Shielded)	1.0~1.5mm ²
AC Ez	4-core cables (Shielded)	1.0~1.5mm ²

- Separation of communication and power lines
 - If communication and power lines are installed alongside each other then there is a strong likelihood of operational faults developing due to interference in the signal wiring caused by electrostatic and electromagnetic coupling.
The tables below indicates our recommendation as to appropriate spacing of communication and power lines where these are to be run side by side.

Current capacity of power line	Spacing	
100V or more	10 A	300 mm
	50 A	500 mm
	100 A	1,000 mm
	Exceed 100 A	1,500 mm

- The figures are based on assumed length of parallel cabling up to 100m. For length in excess of 100m the figures will have to be recalculated in direct proportion to the additional length of line involved.
- If the power supply waveform continues to exhibit some distortion the recommended spacing in the table should be increased.
 - ▷ If the lines are laid inside conduits then the following point must also be taken into account when grouping various lines together for introduction into the conduits
 - ▷ Power lines(including power supply to air conditioner) and signal lines must not be laid inside the same
 - ▷ In the same way, when grouping the lines power and signal lines should not be bunched together.

< ! > CAUTIONS

- If apparatus is not properly earthed then there is always a risk of electric shock, the grounding of the apparatus must be carried out by a qualified person.

6. Field Wiring

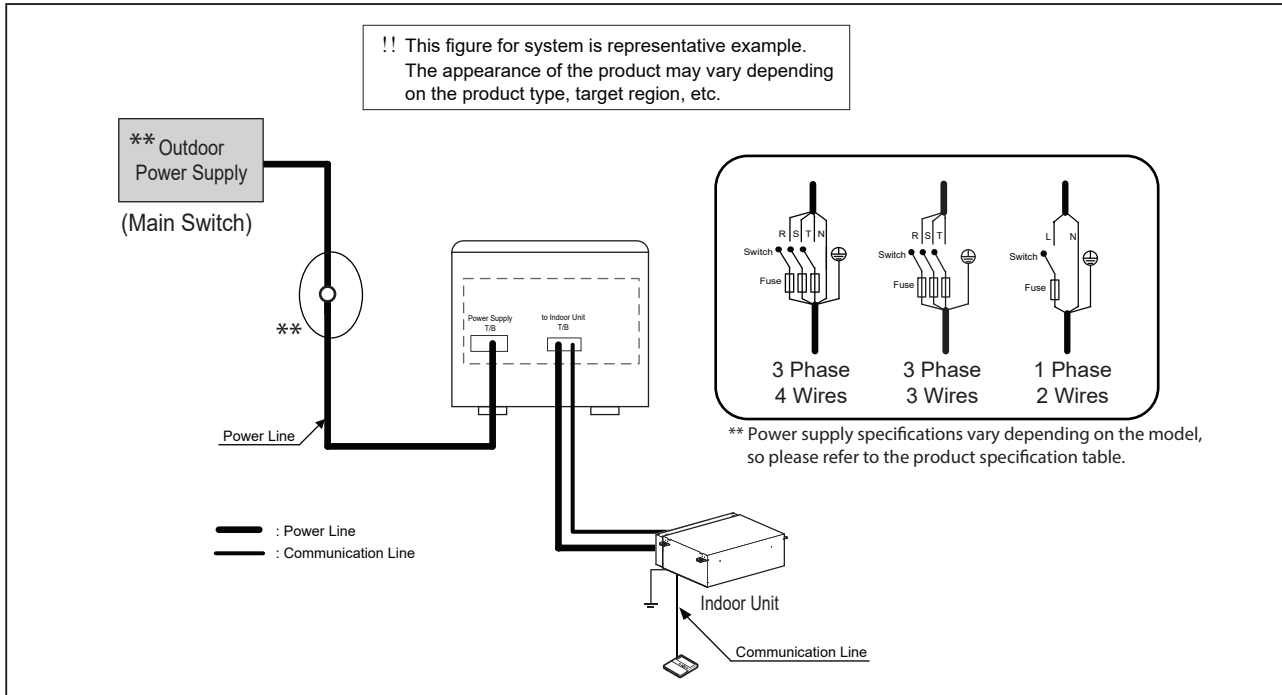

■ Wiring of Main Power Supply

- Bear in mind ambient conditions (ambient temperature, direct sunlight, rain liquid, etc.) when proceeding with the wiring and connections
- The wire size is the minimum value for metal conduit wiring. The power cord size should be 1 rank thicker taking into account the line voltage drops. Make sure the power-supply voltage does not drop more than 10%.
- Specific wiring requirements should adhere to the wiring regulations of the region.
- Power supply cords of parts of appliances for outdoor use should not be lighter than polychloroprene sheathed flexible cord (design 60245 IEC57).
- Don't install an individual switch or electrical outlet to disconnect each of indoor unit separately from the power supply.

< ! > WARNING

- Make sure to use specified wires for connections so that no external force is imparted to terminal connections. If connections are not fixed firmly, it may cause heating or fire.
- Make sure to use the appropriate type of overcurrent protection switch. Note that generated overcurrent may include some amount of direct current.
- All Installation site must require attachment of an earth leakage breaker. If no earth leakage breaker is installed, it may cause an electric shock.
- Do not use anything other than breaker and fuse with correct capacity. Using fuse and wire or copper wire with too large capacity may cause a malfunction of unit or fire.



Air Solution

LG Electronics Inc, 128, Yeoui-daero,
Yeongdeungpo-gu, Seoul, Korea
(07336)

<http://partner.lge.com>

<http://sedc.lge.com>

Copyright 2022 LG Electronics Inc.
All Rights Reserved.

The air conditioners manufactured by LG have received ISO9001 certificate for quality assurance and ISO14001 certificate for environmental management system.
The specifications, designs, and information in this brochure are subject to change without notice.